



**Bridge  
Egypt**  
Construction Services

**BUILDING  
EXCELLENCE  
TOGETHER**

**MKT**<sup>®</sup>  
... a solid connection



**dragon**





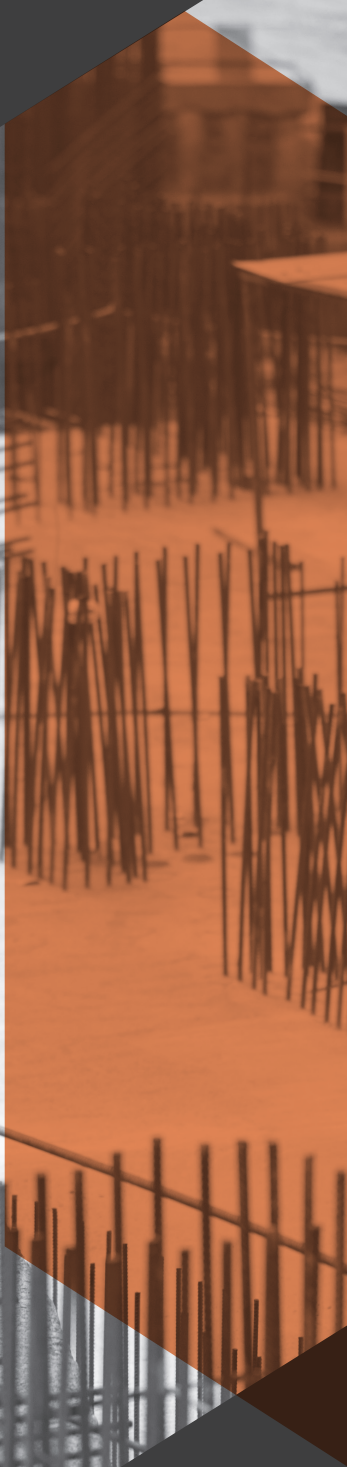

# Index

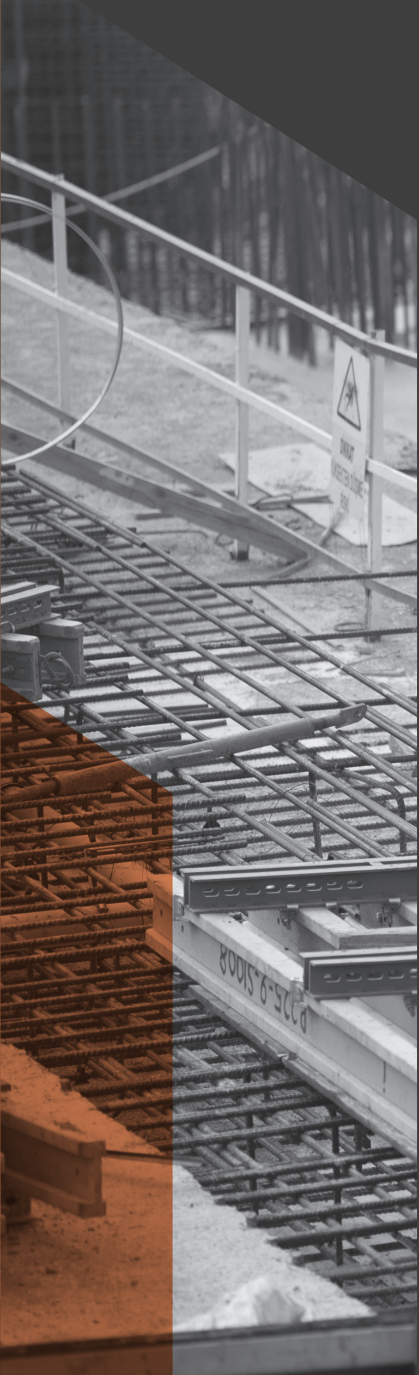

<b>About Us</b>	<b>4</b>
<b>Some of our Approvals</b>	<b>5</b>
<b>Building &amp; Plaster Accessories</b>	<b>6</b>
<i>Building Accessories</i>	<b>8</b>
Standard Wall Tie	8
Fish- Tail Wall Tie	8
Double Fish- Tail	9
F shape Wall Tie	9
L shape Wall Tie	10
Double Triangle Wall Tie	10
Z shape Wall Tie	11
Ladder Block Reinforcement	11
Stone Cladding Clamp	12
<i>Block Work Reinforcement</i>	<b>12</b>
Concrete Reinforcement Metal Mesh	12
Expanded Metal	13
Fiber- Glass Mesh	14
<i>Plaster Accessories</i>	<b>15</b>
Plaster Stop	15
Architrave Bead	15
Angle Bead	16
Corner Bead	16
Control Joint	17
Metal Flashing	18
Termination Bar	19
Zinc Alloy Nails in Anchor	19
<b>Fixing Solutions</b>	<b>20</b>
<i>About MKT</i>	<b>21</b>
<i>Anchor Selection</i>	<b>22</b>
<i>Approvals and Certifications</i>	<b>24</b>
<b>Power Actuated Tools</b>	<b>26</b>
<i>About Dragon</i>	<b>27</b>
<i>Gas Actuated System</i>	<b>28</b>
Concrete Nailer Dragon BE-007	28
Gas Actuated Nails (D6-25)	28
<i>Powder Actuated</i>	<b>29</b>
Concrete Nailer Dragon BE-009	29
Concrete Nailer Dragon BE-1100	30
Nails (DN-27)-(DN-80)	31
<b>Some of our Success Partners</b>	<b>32</b>
<b>Notes</b>	<b>34</b>





## About Us

**Bridge Egypt** is a premier construction service company, renowned for its commitment to quality, integrity, professionalism, and consistency.

Our organization has been a leader in providing dependable solutions for Building Accessories, Power-Actuated Fastening Systems, and Fixing Solutions, leveraging technology and knowledge for over 15 years.

We are dedicated to provide exceptional value throughout the product lifecycle. Our testing and data-driven solutions are designed to help improve the progress efficiency of our valued clients & our team is always available to provide technical advice and assistance, helping customers to get the best results at all times.

Our goal is to enhance the quality of local products to demonstrate that Egyptian products comply with global standards for construction accessories. Furthermore, we are focused on establishing long-term, healthy partnerships built on trust.

By adhering to our mission, we aspire to become the supplier of choice for our customers, and to be recognized as the largest company in Africa and the Middle East.





# Some of our Approvals

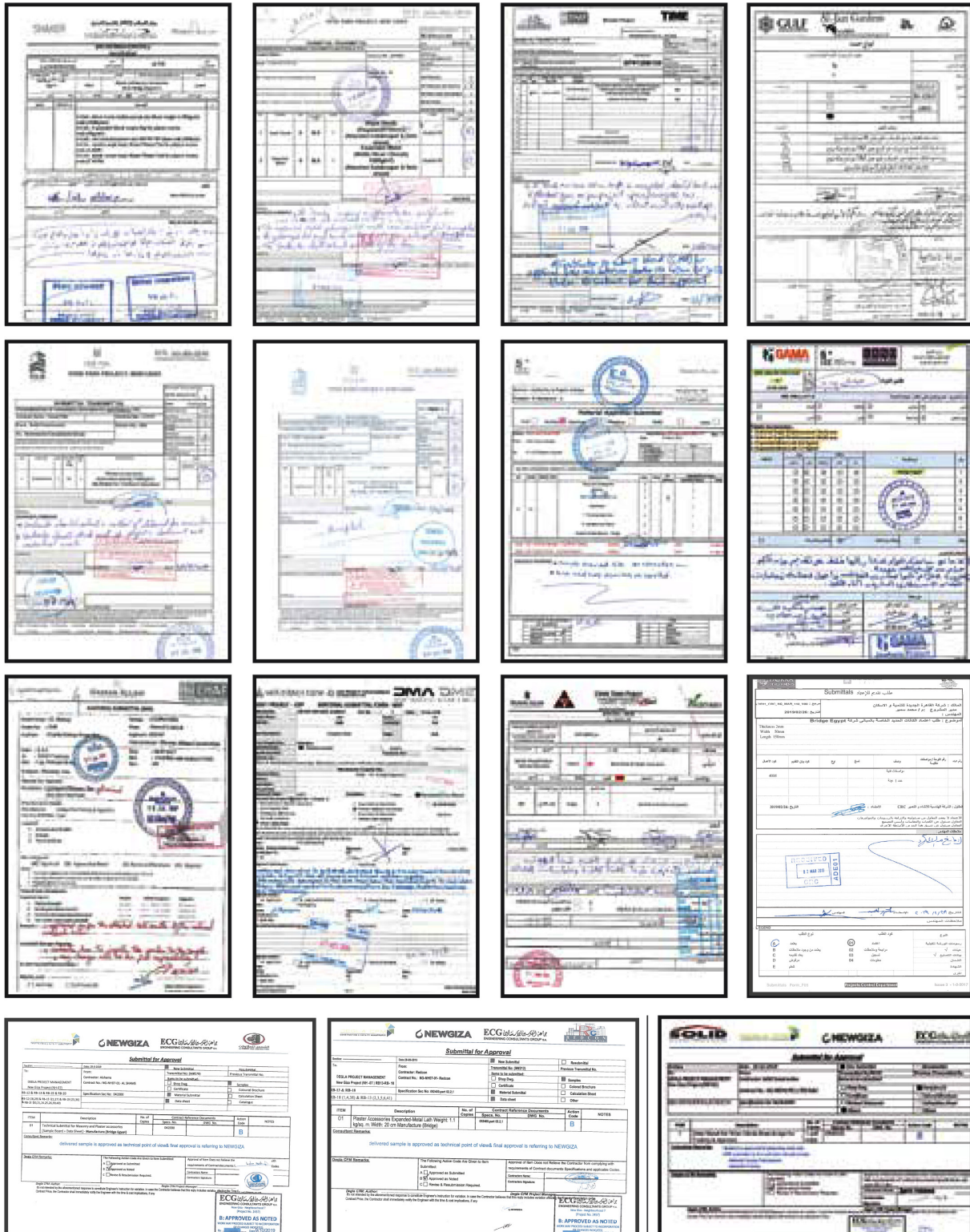



# Building & Plaster **Accessories**





A construction site at sunset. A large yellow crane is in the center, with its arm extending across the frame. The ground is covered with a grid of rebar. In the background, there are stacks of blue materials and other construction elements. The sky is a mix of orange and yellow, with the sun low on the horizon. A large orange triangle is overlaid on the right side of the image.

We are dedicated to deliver high-quality building and plaster accessories to our valued customers, enabling them to create a superior final finish on their projects. We understand the importance of reliability and durability, so we strive to provide products that meet our strict quality standards, giving our customers the confidence to trust us. With our range of accessories, it is possible to achieve a truly remarkable end result.

 Bridge  
Egypt



## Standard Wall-Ties (WT-S)

### ◆ Building Accessories- wall-ties.

Contribute significantly to the stability, the stiffness and durability of the structure. Typically, wall ties perform three primary functions between concrete elements and masonry or a wythe of brick and its backing or another wythe of masonry:

1. provide a connection, 2. transfer lateral loads, 3. permit in-plane movement to accommodate differential movements and, in some cases, restrain differential movement. In addition to these primary functions, metal ties (as joint reinforcement) may also be required to serve as horizontal structural reinforcement or provide longitudinal continuity.

- ▶ Manufactured from Galvanized steel sheet (BS EN 10130:2017) - (ASTM A653/A653M).

Code	Thickness mm	Width mm	Length (L) mm
WT-S1.5A	1.5	20 : 50	150
WT-S1.5B	1.5	20 : 50	200
WT-S1.5C	1.5	20 : 50	250
WT-S1.5D	1.5	20 : 50	300
WT-S2A	2	20 : 50	150
WT-S2B	2	20 : 50	200
WT-S2C	2	20 : 50	250
WT-S2D	2	20 : 50	300
WT-S2.5A	2.5	20 : 50	150
WT-S2.5B	2.5	20 : 50	200
WT-S2.5C	2.5	20 : 50	250
WT-S2.5D	2.5	20 : 50	300

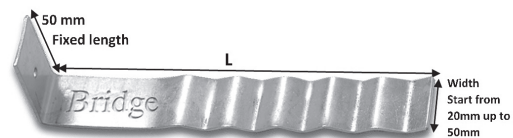

Code	Thickness mm	Width mm	Length (L) mm
WT-S3A	3	20 : 50	150
WT-S3B	3	20 : 50	200
WT-S3C	3	20 : 50	250
WT-S3D	3	20 : 50	300
WT-S4A	4	20 : 50	150
WT-S4B	4	20 : 50	200
WT-S4C	4	20 : 50	250
WT-S4D	4	20 : 50	300

## Wall-Tie Fish-tail (WT-FT)

### ◆ Building Accessories- wall-ties.

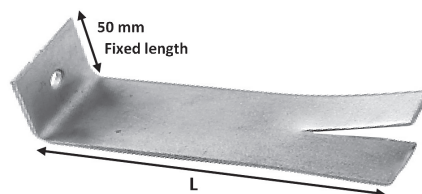

Code	Thickness mm	Width mm	Length (L) mm
WT-FT2A	2	30	150
WT-FT2B	2	30	200
WT- FT2.5A	2.5	30	150
WT- FT2.5B	2.5	30	200
WT-FT3A	3	30	150
WT-FT3B	3	30	200



## Wall-Tie Double Fish-tail (WT-DFT)

### ◆ Building Accessories- wall-ties.

Is a tie installed by overlapping concrete posts so it acts as an anchor with two ends to be tied in masonry or between two masonry walls in a uniform Spacing pattern to help eliminate settlement and different thermal expansion cracks and make the wall act as one structure. Contribute significantly to the stability, the stiffness and durability of the structure.

- ▶ Manufactured from Galvanized steel sheet (BS EN 10130:2017) (ASTM A653 / A653M).

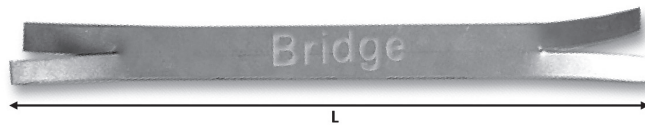

Code	Thickness mm	Width mm	Length (L) mm
WT-DFT2A	2	30	150
WT-DFT2B	2	30	200
WT-DFT2C	2	30	250

## Wall-Tie F shape (WT-F)

### ◆ Building Accessories- wall-ties (Overhead).

Are designed for restraining the free standing wall with the overhead structure.

it's being used for linking the wall with ceiling to reinforce the building against lateral loads.

- ▶ Manufactured from Galvanized steel sheet (BS EN 10130:2017) - (ASTM A653 / A653M).

Code	Thickness mm	Width mm	Length (L) mm
WT- F2A	2	30	250
WT- F2B	2	30	300
WT-F3A	3	30	250
WT-F3B	3	30	300

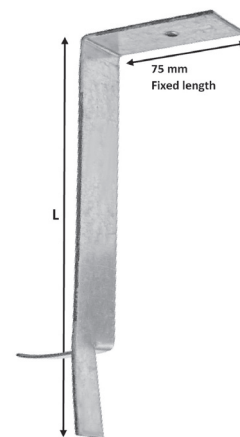

### Wall-Tie L Shape “Steel Bracket” (WT-L)

Are an essential part of the vertical supporting systems and columns when it comes to cladding and fixations of the almost any vertical components. It provides a strong Mechanical fixing solution while allowing the movement of the structure due to its oversized bolt holes.

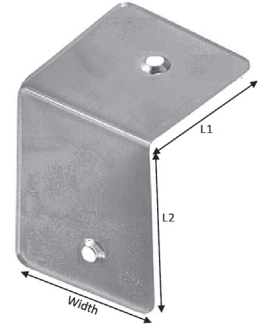

Code	Thickness mm	Width mm	Length mm	
			(L1)	(L2)
WT-L	5	30 : 200	50 : 150	50 : 150

### Double Triangle Wall-tie (WT-DT)

◆ Building Accessories- wire-tie

Is used in cavity walls to reinforce and hold the two walls together. The laid with the twisted wire ends hanging down into the cavity to act as a drip to prevent moisture from traveling across the cavity. It has a bend in the middle of its length and the strip tie has a twist as a barrier to moisture passing across the tie. Confirms to

**BS EN 1996-1-1 and BS EN 1996-2**

**ASTM A641 / A641M**

- ▶ Manufactured from Galvanized steel wire with diameter of 4.8 mm.

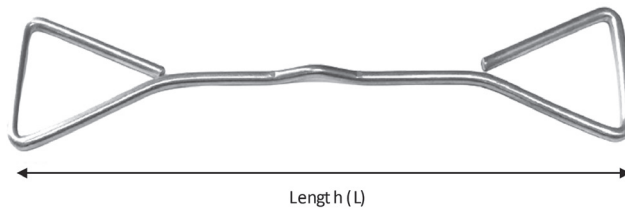

Code	Length (L) mm	Material
WT-DT2.5	250	Galvanized steel wire



## Z-Shaped Wire Wall-tie (WT-Z)

### ◆ Building Accessories- wire-tie

Used in cavity walls to reinforce and hold the two walls together by being placed horizontally inside the mortar.

The main usage is to act as an anchor and unite different walls to act as one. Always used with a width 50 mm less than the width of the wall. Confirms to

**BS EN 1996-1-1 and BS EN 1996-2**

**ASTM A641 / A641M**

- ▶ Manufactured from Galvanized steel wire with diameter of 4.8 mm.

Code	Length mm
WT-Z10	100

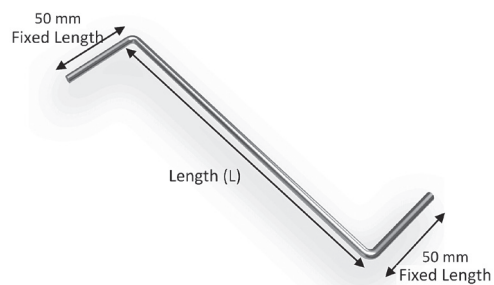

## Ladder Wall Tie (LWT)

### ◆ Building Accessories- Cavity wall support

Ladder wire tie terrace like wire tie used in cavity walls to reinforce and hold the two walls together to act as a

single structure and also could be used as block work reinforcement by being placed horizontally inside the mortar in single walls usage.

Always used with a width 50 mm less than the width of the wall.

Confirms to

**BS EN 1996-1-1 and BS EN 1996-2**

**ASTM A641 / A641M**

- ▶ Available to be Manufactured from Galvanized steel wire with diameter of 4.8 mm.

Code	Length m	Width cm	Material
LWT-10	3	10	Galvanized steel wire
LWT-15	3	15	Galvanized steel wire
LWT-20	3	20	Galvanized steel wire

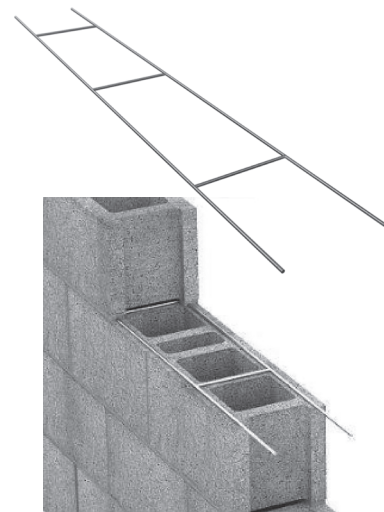

## Stone Cladding Clamp (CC)

### ◆ Mechanical Stone Cladding Systems

Stone Cladding Clamp is used to mechanical apply and fix wall cladding of granite, marble, travertine, and other tiles. Suitable for concrete walls. Quick and easy installed to restrain against wind pressure and quake-proof: expansion fasteners, Bolt Nut, Anchors, Rivets, etc.

Available in multiple materials:

- ▶ Stainless Steel 304, 316.
- ▶ Galvanized Steel.
- ▶ Hot Dip Galvanized Steel.

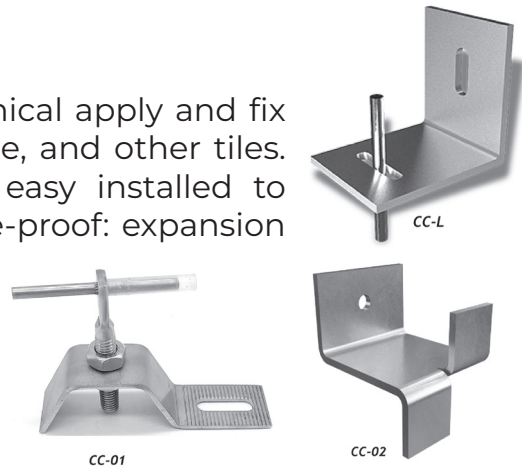

Code <sup>1)</sup>	Thickness mm	Width mm	Length mm	Hole Size mm
CC-01	3	40	50 x 35 x 50 x 35	10 x 32
CC-02	3	40	20 x 50 x 50	10 x 32
CC-L	5	40	50 x 50	10 x 32

## Concrete Reinforcement Metal Mesh (CMM)

### ◆ Building Accessories- Concrete Reinforcement

Concrete Reinforcement Metal Mesh is a heavy duty expanded metal produced from carbon steel sheet to achieve best bonding with concrete. Contains no joints or welds, as each sheet is a single piece of sturdy steel acting as shear connection reinforcement and also supplied as an anti-crack reinforcement in the design. It is recommended for usage with concrete plaster and reinforcement work.

- ▶ Manufactured from **Carbon Steel**.
- ▶ Roll Dimensions: 1 meter width x 10 meter length.
- ▶ Available Densities: from (0.600 kg/m<sup>2</sup>) to (1.800 kg/m<sup>2</sup>)

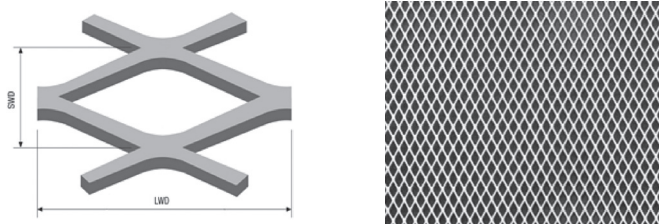

Code	Mesh Dimension	
	SWD	LWD
CMM-525	11	25
CMM-615	5	15
CMM-625	11	25
CMM-815	4.8	15



## Expanded Metal (EM)

### ◆ Building Accessories- Expansion reinforcement

A multiple usage and key factor when it comes to both masonry and plaster works.

Expanded metal mesh is one of the most versatile products that contribute in eliminating tiny cracks that ruins the good looks of your wall.

Could be used as a masonry reinforcement by reducing settlement in blockwork due to its weight.

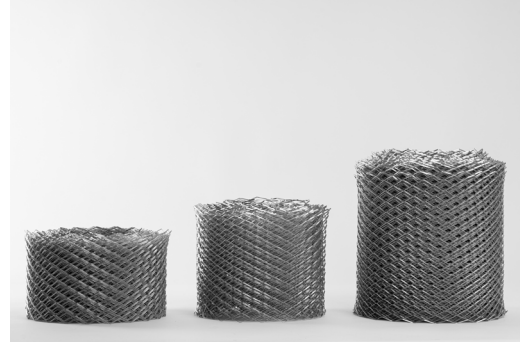

Also has an outstanding role in plaster works when it comes to stop tiny cracks resulted by different thermal co-efficient of different materials.

Not only that but it can help in building up layers in plaster process and provides good bonding between layers plus could be used to cover up electric lines and eliminate plaster cracks resulted by them.

- ▶ Manufactured from Galvanized steel sheet: **BS EN 10130**.

Code	Density	Width	Length
EM-500	0.500 Kg/m <sup>2</sup>	From 8cm till 100cm	10 M - 20 M
EM-600	0.600 Kg/m <sup>2</sup>	From 8cm till 100cm	10 M - 20 M
EM-700	0.700 Kg/m <sup>2</sup>	From 8cm till 100cm	10 M - 20 M
EM-800	0.800 Kg/m <sup>2</sup>	From 8cm till 100cm	10 M - 20 M
EM-900	0.900 Kg/m <sup>2</sup>	From 8cm till 100cm	10 M - 20 M
EM-1000	1000 Kg/m <sup>2</sup>	From 8cm till 100cm	10 M - 20 M
EM-1100	1.100 Kg m <sup>2</sup>	From 8cm till 100cm	10 M - 20 M
EM-1200	1.200 Kg/ m <sup>2</sup>	From 8cm till 100cm	10 M - 20 M
EM-1300	1.300 Kg/m <sup>2</sup>	From 8cm till 100cm	10 M - 20 M
EM-1400	1.400 Kg/m <sup>2</sup>	From 8cm till 100cm	10 M - 20 M
EM-1500	1.500 Kg/m <sup>2</sup>	From 8cm till 100cm	10 M - 20 M
EM-1630	1.630 Kg/m <sup>2</sup>	From 8cm till 100cm	10 M - 20 M
EM-1700	1.700 Kg/m <sup>2</sup>	From 8cm till 100cm	10 M - 20 M
EM-1850	1.850 Kg/m <sup>2</sup>	From 8cm till 100cm	10 M - 20 M
EM-1900	1.900 Kg/m <sup>2</sup>	From 8cm till 100cm	10 M - 20 M

## Fiber Glass Mesh (FGM)

### ◆ Plaster Accessories - Expansion reinforcement

Is resin coated fiberglass fabric that does not burn and is characterized by both low weight and high strength. These properties allow it to be successfully used in the formation of joints of two materials with different expansion coefficient and resist the cracking that occurs in such places.

Resistant to alkalis, does not decompose over time, it has a high resistance to tearing and stretching, protects the surface from cracking and improves its mechanical strength due to its flexibility. Easy to handle and use.

### Technical Proprieties:

#### FGM-W:

##### a) Coating and Alkaline Resistance:

Adhesive coating (%): **Acrylic Latex  $\geq 18 \pm 3$  %.**

Alkaline Resistance: After 28-days immersion of **5% NaOH solution.**

Average Retention rate for tensile fracture strength:  **$\geq 60\%$ .**

##### b) Mechanical Properties:

##### Tensile Strength:

- (50mm Width Tensile Method): **Warp  $\geq 1200$  N, Weft  $\geq 1500$  N.**

- (Wide Width Method ASTM D-5035): **Warp  $\geq 1050$  N, Weft  $\geq 1400$  N.**

#### Elongation

- (Wide Width Method ASTM D-5035): **Warp  $\geq 5\%$ , Weft  $\geq 8\%$ .**

#### FGM-R:

**Tensile Strength: (50mm Width Tensile Method): warp  $\geq 1000$  N, weft  $\geq 1400$  N.**

Confirms to: **ETAG 004**

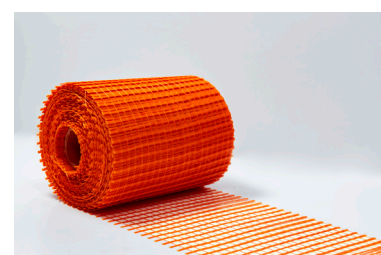
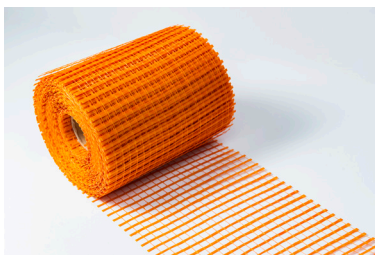

Code	Hole size mm	Density	Width cm	Length	Color
FGM-W	5 x 5	125 g/m <sup>2</sup> +/- 5%	20	50 meters +/- 5%	White
FGM-R	10 x 10	120 g/m <sup>2</sup> +/- 5%	20	40 meters +/- 5%	Red
FGM-O	10 x 10	90 g/m <sup>2</sup> +/- 5%	20	50 meters +/- 5%	Orange



## Plaster Stop (PS)

### ◆ Plaster Accessories

Is used for many different applications and can also be less expensive than other construction methods. It is designed with a ridge of nail holes to provide easy installation. And Used in all types of buildings and constructions and all cement plastering work, Plaster stop beads improve the structure's quality regarding the wall surfaces' abutments to other dissimilar surfaces. It is also used between wall surfaces and abutment of doors and window frames and places wherever the plaster ends.

- ▶ Confirms to: **BS EN 13658-1**
- ▶ Manufactured from Galvanized steel sheet (**BS EN 10130:2017**) - (**ASTM A653 - A653M**).
- ▶ Rod Length is **3 meters**.

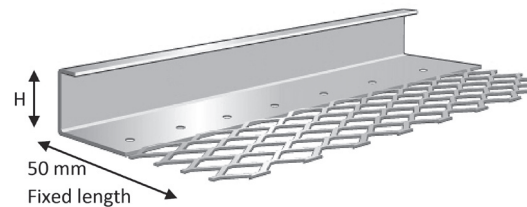

Code	Height (H) mm
PS-10	10
PS-13	13
PS-15	15
PS-19	19

## Architrave Bead (AB)

### ◆ Plaster Accessories

Act as a plaster stop profile, creating a shadow-like recess. Typical applications include the creation of clean divisions between different wall finishes, at walls and ceiling abutments, door and window reveals and other built in joinery features.

### Comes in two shapes

- ▶ One wing architrave bead "**AB**".
- ▶ Two wing architrave bead "**ABD**".
- ▶ Manufactured from Galvanized steel sheet (**BS EN 10130:2017**) - (**ASTM A653/A653M**).

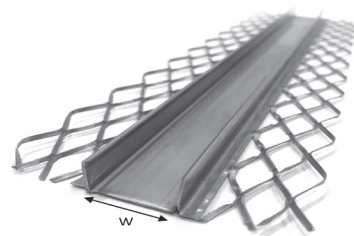

Code	Channel Width (W) mm	Rod Length m
AB-20	20	3
AB-25	25	3
ABD-20	20	3

## Angle Bead (AD)

### ◆ Plaster Accessories

Is type of reinforcement designed for internal and exterior plaster use, reinforced with flange wings to provide with its solid metal nose a straight corner. designed to protect the corners from impacts that damage the straight lines and keep a precise straight edges.

- ▶ Manufactured from Galvanized steel sheet **(BS EN 10130:2017) - (ASTM A653 - A653M)**.
- ▶ Rod Length is **3 meters**.

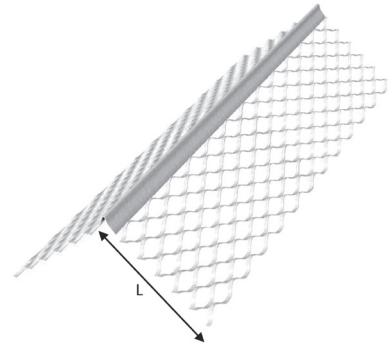

Code	Flange Length (L) mm
AD-50	50 × 50
AD-70	70 × 70

## Corner Bead (CM)

### ◆ Plaster Accessories

Designed to provide strong internal corner reinforcement for conventional plaster applications and perfectly straight sharp inside corners and designed to resist cracking.

A solid metal nose provides a straight, rigid ground, and the flanges can be easily flexed over irregular, uneven surfaces. Uses to ensure successful corner alignment and efficient plaster keying.

- ▶ Manufactured from Galvanized steel sheet **(BS EN 10130:2017) - (ASTM A653 - A653M)**.
- ▶ Rod Length is **3 meters**.

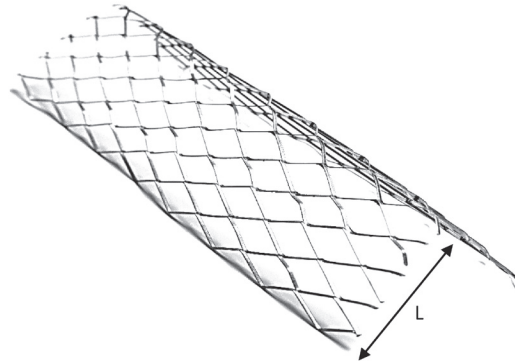

Code	Flange Length (L) mm
CM-50	50 × 50
CM-70	70 × 70



## Control Joint (CJ)

### ◆ Plaster Accessories

Is used in concrete masonry and plaster works to reduce the occurrence of shrinkage-related cracking.

A control joint could be used in both vertical and horizontal joints filled with mortar, but with a bond breaker on one side, tensile stress cannot develop across the joint.

Along the wall's length and near corners, returns, and changes in the wall's height, support, or stiffness.

Can be used as an expansion joint reinforce and control joint reinforce.

Comes in two shapes:

**CJ-V: Joint with Single V bend.**

**CJ-DV: Joint with Double V bend.**

- ▶ Manufactured from Galvanized steel sheet (**BS EN 10130:2017**) - (**ASTM A653 - A653M**).

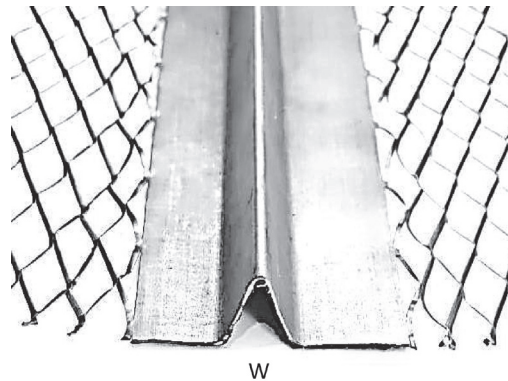
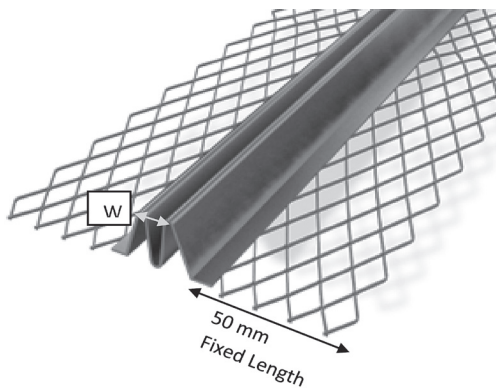

Code	Type of Bend	Bend Width (W) mm
CJ-V18.5	Single V	18.5
CJ-DV19	Double V	19

## Metal Flashing (MF)

### ◆ Building Accessories - Insulation

is a type of metal insulation that is used at the end of isolation panels and directs water away from the roof's critical areas where water can go through and damage concrete. Also, it uses in a flashing or trim capacity for various areas of a home, which may include valleys, chimneys, fascia, end walls, sidewalls, and many others. It is fastened by the screws you make at its end at an angle of 45°, filling the spaces between sheet and wall with a rubber sealant material to prevent leaking water.

#### Available to be Manufactured from:

- ▶ Galvanized steel sheet (**BS EN 10130:2017**) - (**ASTM A653 - A653M**).
- ▶ Stainless Steel 304
- ▶ Aluminum Sheets

Recommended to be fixed using **Zinc Alloy Anchor ZA**

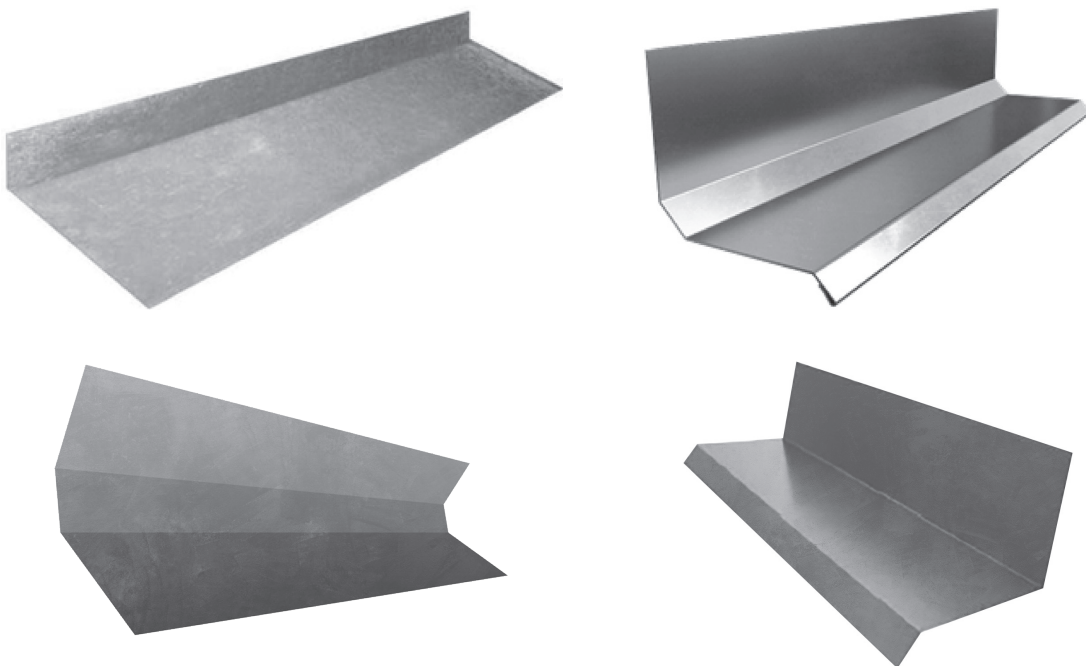

Code <sup>1</sup>	Thickness mm	Width mm	Rod Length m
MF-01	0.7 mm	25 × 50	2 m
MF-02	0.7 mm	15 × 35	2 m
MF-03	0.7 mm	70 × 235 × 50	2 m
MF-04	0.7 mm	20 × 25 × 85	2 m

<sup>1</sup> Dimensions are most common produced sections, Custom dimensions and section available upon request.



## Termination Bar (TB)

### ◆ Building Accessories – Insulation

is a multi-purpose, professional way to fix a wide variety of construction waterproofing, drainage boards, insulation systems and metal flashing systems. Due to the usage of water sealant or PVC strips over the bar it provides a perfect water tight insulation.

- ▶ Manufactured from Galvanized steel sheet (**BS EN 10130:2017**) - (**ASTM A653 - A653M**).
- ▶ Recommended to be fixed using **Zinc Alloy Anchor ZA**

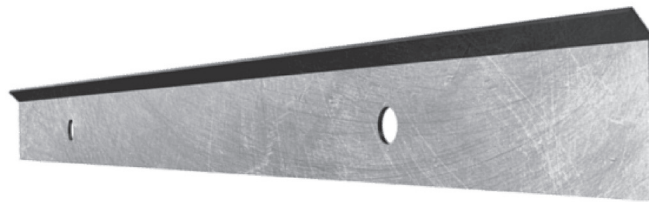

Code	Thickness mm	Rod Length m	Width mm
TB	0.7	2	40

## Zinc Alloy Nails in Anchor (ZA)

### ◆ Fixing Solution

in Anchor for a light-duty mechanical anchor is easy to install, used in Concrete, Block, Brick, and stone. Recommended to be used in fixation of Metal flashing, Foundation weep screed and Termination Bar systems.

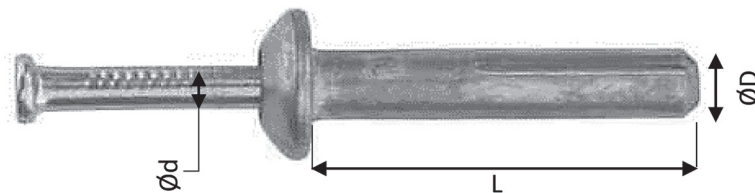

Code	Dimensions	Material
ZA-01	DIA-D	6.0 mm
	Length	30 mm
	DIA-d	3.70 mm
	6×30	Zinc Alloy

# Fixing Solutions







**MKT is one of the leading German manufacturers of Anchors, specializing in a wide range of high-quality Mechanical, Chemical, and Light-duty anchors for a wide assortment of Light Medium, and Heavy-duty applications. It can also suit your fixing requirements in all areas of application both cracked and non-cracked concrete.**

**MKT<sup>®</sup>**

... a solid connection

# ANCHOR SELECTION



... a solid connection

	Mechanical Heavy Duty Anchors															
	Wedge Anchor BZ3	Wedge Anchor BZ3 dyn	Wedge Anchor BZ plus / sh	Wedge Anchor BZ plus A4	Wedge Anchor BZ plus HCR	Wedge Anchor BZ-IG	Wedge Anchor BZ-IG A4/HCR	Wedge Anchor B	Wedge Anchor B hot dip gal.	Wedge Anchor B A4	Wedge Anchor B HCR	Wedge Anchor B-IG / B-IG A4	Nail Anchor N, N-K	Nail Anchor N-M	Drop-in Anchor E, ES	Drop-in Anchor E A4 / E HCR
Cracked Concrete	•	•	•	•	•	•	•									
Non-cracked Concrete	•	•	•	•	•	•	•	•	•	•	•	•			•	•
Multiple Use in Concrete <sup>1)</sup>										•	•		•	•	•	•
Pre-stressed Concrete Hollow Slabs															•	
Hollow Brick																
Solid Brick																
Autoclaved aerated concrete																
Drywall																
ETA Assessment	•	•	•	•	•	•	•	•	•	•	•		•	•	•	•
DIBT Approval																
Fire Resistant	•	•	•	•	•	•	•	•	•	•	•		•	•	•	•
Fire Resistant in Tunnels				•									•			
ICC Approval																
Approved for fatigue loading		•														
Approved for seismic action	•	•	•	•	•											
VdS	•		•	•	•	•	•							•	•	•
FM			•	•	•			•		•					•	•
Swiss Shock Approval	•		•	•	•	•	•									
Steel, Zinc Plated	•	•	•			•		•				•	•	•	•	
Steel, Hot Dip Galvanized			• <sup>2)</sup>						•							
Stainless Steel A4/316				•			•			•		•	•			•
Stainless Steel HCR, 1.4529					•		•				•		•			•
Hollow drill bit	•	•	•	•	•	•	•	•	•	•	•				•	•
Design Software available	•	•	•	•	•	•	•	•	•	•	•	•			•	•





# APPROVALS AND CERTIFICATES



... a solid connection



Certification according to ISO 9001, ISO 14001, ISO 50001 and OHSAS 18001.



European Technical Assessment (ETA) with CE marking.



Approval by 'Deutsches Institut für Bautechnik' in Berlin, Germany.



ICC Evaluation Service listing, USA.



Shock approval by 'Bundesamt für Bevölkerungsschutz' in Bern, Switzerland.



Factory Mutual (FM), U.S. approval for installation of sprinkler systems.



Suitable for installation of sprinkler systems as per requirements of VdS Schadenverhütung GmbH, Germany.



VdS Schadenverhütung GmbH, Germany, approval for installation of sprinkler systems.



Fire resistance tested according to standard temperature curve considering DIN EN 1363-1 and in dependence of TR 020. For anchors not suitable for tension zones, it has to be verified and assessed depending on the design situation if the design method stated in TR 020 can be applied. See also page 166-168.



Tested according to ZTV-tunnel temperature curve. See also page 169.



Tested according to RWS-tunnel temperature curve.



Identifies anchors that are approved for fatigue loading.



Identifies anchors suitable for use under seismic loading.



Material sign for stainless steel (A4 grade 316 or HCR material 1.4529).



NSF International certification for use in drinking water and food systems..



Indicate the emission-class after the French directive (No. 2011-321 from 2011/03/23) on the labeling of building products for their indoor air emissions. The emissions are rated on a scale of A+ (very low emissions) to C (high emissions).



EPD-Environmental Product Declaration according ISO 14025 and EN 15804 by the Institut Bauen und Umwelt e.V. (IBU).



Indicates the anchors for which further steps of cleaning after the bore hole drilling can be omitted due to the usage of the Hollow drill bit SB.



Included in MKT Design-Software



# Power-Actuated Tools







Dragon product engineers concentrate on developing products with highly innovative and durable features to Support the ever-evolving needs of the professionals that use them.

**dragon** 

# GAS ACTUATED CONCRETE NAILER DRAGON BE-007

## Dragon BE-007

The Gas actuated Concrete Nailer is a viral and efficient building fastening systems which include gas tool, fuel cell, and strip fasteners. The gas tool absorbs flammable gas from the fuel cell and mixes it in its air cylinder.

The mixture is ignited by an electric device and produces much high-pressure gas, which pushes the piston to push the strip fastener into the concrete.



**Gas Concrete Nailer 007**

Dimensions Length x Height x Width	15.9 x 17.3 x 4.3
	403mm x 440mm x 109mm
Weight includes battery and fuel cell	7.48 lbs. (3.4 kg)
	7.9 lbs. (3.6 kg)
Nail Capacity	32 Nails (3 strips)
Cycle Rate	Intermittent: 2-3 nails per second
	Continuous: 1000 nails per hour

**Battery Charger**

Switching adaptor input power source	Single phase: AC 110-240V ~5060 Hz
Charging Time	5 min. can shoot 200 nails
	Max. 120 min. (At temperature of 70 F (20 C))
Charging Voltage	Dc 7.4 V
Charging Current	Dc 2.2 A
Weight (not including switching adaptor)	bs. (0.11 Kg)

## Gas Actuated Nails (D6-25)

- ◆ Shank in carbon steel with Plastic collated strip (10 Nails per strip).

Electro galvanized, min zinc coating 5 µm.

Hardness: 50 to 55 HRc.

Comes in row of 10 nails per strip.

To be used with **Dragon BE-007 Gas Gun**, only 1 Gas Tube to shoot **1000** Nail.

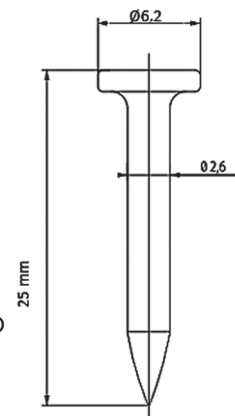

Length mm	Head Diameter mm	Pin Diameter mm
25	6.2	2.6



## POWDER ACTUATED CONCRETE NAILER DRAGON BE-009

The Powder actuated tool is a type of nail gun used in construction and manufacturing to join

materials to hard substrates such as steel and concrete.

Known as direct fastening, this technology relies on a controlled explosion created by a small chemical propellant charge, similar to the process that discharges a firearm. This power actuated tool has advantages of safety, sure and easy operation, convenience in maintenance, widely used in various industries as metallurgy, construction, ornamenting, ship building, etc.



Length	34 cm
Weight	2.5 kg
Pin length capacity	1-5/8" – up to 50 mm
Pin type	YD, HYD, PD, HPD, M6A, HM6A, M8, HM8
Power level	Green (3), Yellow (4), Red (5)
Load Type	S1J, S1JT
Handle grip	Durable Polyamide housing
Recommended reinforced concrete compressive strength	from 400 kg/cm <sup>2</sup> up to 650 kg/cm <sup>2</sup> (compressive strength after 28 days)
Manufacturing origin	China
Recommended powder nails	DN - 27
Pin Length Capacity	Up to 62 mm

## POWDER ACTUATED CONCRETE NAILER DRAGON BE-1100

**NEW  
GENERATION**  
MADE IN TAIWAN

The Powder actuated tool is a Single-shot fastening with automatic piston reset by rubber returner. Deliver productive fastening. Dragon BE-1100 can shoot in fully automatic mode, without continuous change of the nail. It's Easy disassembly for cleaning, convenient maintenance, capable of shooting nails of length up to 50mm, and widely used in various industries like metallurgy, construction, ornamenting, shipbuilding, etc.



Length	42 cm
Weight	2.8 kg
Pin length capacity	1-5 / 8" – up to 50 mm
Pin type	8mm Headed Fasteners, or ¼" – 20 Threaded Studs
Power level	Yellow (4), Red (5)
Load Type	6.8/11M(.27 Caliber) 10 – Shot Strip loads
Handle grip	Durable Polyamide housing
Recommended reinforced concrete compressive strength	from 400 kg/cm <sup>2</sup> up to 650 kg/cm <sup>2</sup> (compressive strength after 28 days)
Manufacturing origin	Taiwan
Recommended powder nails	DN - 27
Pin Length Capacity	Up to 62 mm

# POWDER ACTUATED NAILS : (DN-27) - (DN-80)



**Powder Nails** come in Box of 100 nails to be used with compatible Powder concrete nail guns:

- ▶ Dragon BE-1100
- ▶ Dragon BE-009

Steel Grade	Material	Length mm	Head Diameter mm	Pin Diameter mm
60	Zinc Plated	27	8	3.7
60	Zinc Plated	80	8	3.7

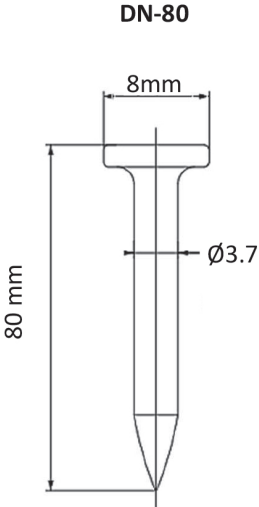
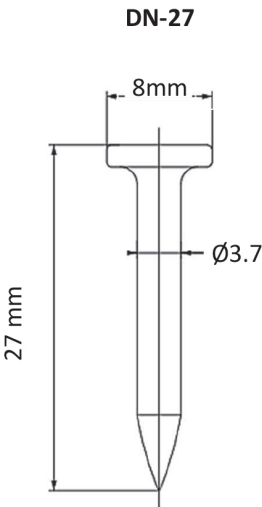





## Some of our Success PARTNERS













Your vision,  
our expertise – together,  
we build excellence.



Info@Bridgeegypt.com  
Sales@Bridgeegypt.com



(+2) 01001230469 | 01004720905  
01013077702 | (+2) 38241931



[www.Bridgeegypt.com](http://www.Bridgeegypt.com)



50 Al-Syahlia Area Behind Juhayna Sq.  
6<sup>th</sup> of October - Giza, Egypt.