



# **KAYCAN**

PRODUCT CATALOGUE

**KAYCAN**

[www.kaycan.com](http://www.kaycan.com)

Consult your local Kaycan distribution centre for product availability.  
1-800-952-9226

Specifications and colors are subject to changes without notice,  
manufacturer shall not be liable.

Every effort has been made to make the colors in this catalogue as  
accurate as possible. However we recommend making final color  
decisions using actual color samples.

SCAN THIS QR CODE  
TO VISIT OUR WEBSITE





### Vinyl Siding and Trims

Richmond .....	6
Richmond Ultra .....	7
Ocean Park XL .....	8
Ocean Park XL Ultra .....	9
DaVinci .....	10, 11
Verona .....	12, 13
Hardwood Valley II Variegated Siding .....	14
Montebello Vinyl Log Siding .....	15
Timberlake .....	16, 17
Vertical Vinyl Siding .....	18
Prova .....	19
Perfection Shingles .....	20 to 21
Vinyl Soffits .....	22, 23
Vinyl Trims .....	24 to 27
AgriTUFF .....	28
Vinyl Skirting .....	29

### Aluminum Soffit, Siding and Trims

Aluminum Siding .....	31
Urbanix .....	32 to 33
Altix .....	34
Aluminum Soffit .....	35
Aluminum Trims and Accessories .....	36, 37
Aluminum Roof Edges and Fascias .....	38, 39
Metal Flashing and Trims .....	40, 41

### Prefinished Engineered Wood Products

Hampton Shake .....	44
Trimboard .....	45

### Rain Carrying Systems

Performance Aluminum Rainware .....	48 to 51
Gutter Coils and Accessories .....	52, 53
K-Snap Vinyl Rainware .....	54, 55
Classic Half-Round Vinyl Rainware .....	56
U-Snap Vinyl Rainware .....	57

### Deco-Architectural Elements

Vinyl Shutters .....	60, 61
Aluminium Shutters .....	62
Headers .....	63
Door Surrounds .....	64
Gable Vents .....	65
Mount Blocks .....	66, 67
Speciality Mount Blocks and Vents .....	68, 69
Speciality Vents .....	70, 71

### Insulation, Sealants and Fasteners

Insulation Sealants and Fasteners .....	74
Roof Ventilation .....	75
Web Site .....	76, 77

BRING YOUR VISION TO LIFE.



**HOMEDESIGNER 2.0**

Redesigning the exterior of your home has never been this easy.  
Better options and endless combinations.



Use a sample home



Upload your own picture



Upload your own drawing

#buildinglastingimpressions



Available only at  
**www.kaycan.com**

**KAYCAN**



# **KAYCAN**

## BUILDING LASTING IMPRESSIONS

### **Unparalleled Quality**

Superior performance, outstanding beauty, durability, and low maintenance are the standards of excellence which distinguish Kaycan products from its competitors. Kaycan's passion for quality, beauty, and performance has enabled Kaycan to remain a market leader in the manufacturing of vinyl and aluminum building products in North America for over four decades.

### **State-of-the-Art Manufacturing**

Kaycan is one of the world's leading manufacturers of vinyl and aluminum siding, rainware, as well as coil products. We own and operate more than 1,500,000 square feet of technologically advanced manufacturing facilities in eleven plants. Our manufacturing plants follow rigorous quality control and testing requirements that meet and exceed the most stringent industry and government standards, at all stages of manufacturing. With over 2,500,000 square feet of distribution space in 60 distribution centres across North America, we are able to meet our customers' most stringent delivery requirements.

### **Innovation and Technology**

Kaycan is committed to improving customer satisfaction through continuous strategic improvements to manufacturing processes. While the look and style of Kaycan products are inspired by timeless quality craftsmanship, it is modern engineering and technology that enhance overall performance, durability, and ease of maintenance.

### **Experience and Reliability**

As a family owned and operated company for over four decades, quality care, reliability, and trust remain our most important values. An extensive range of products available in locations throughout the globe, supported by decades of experience and outstanding physical and human resources, enable us to consistently deliver on schedule and to specification.



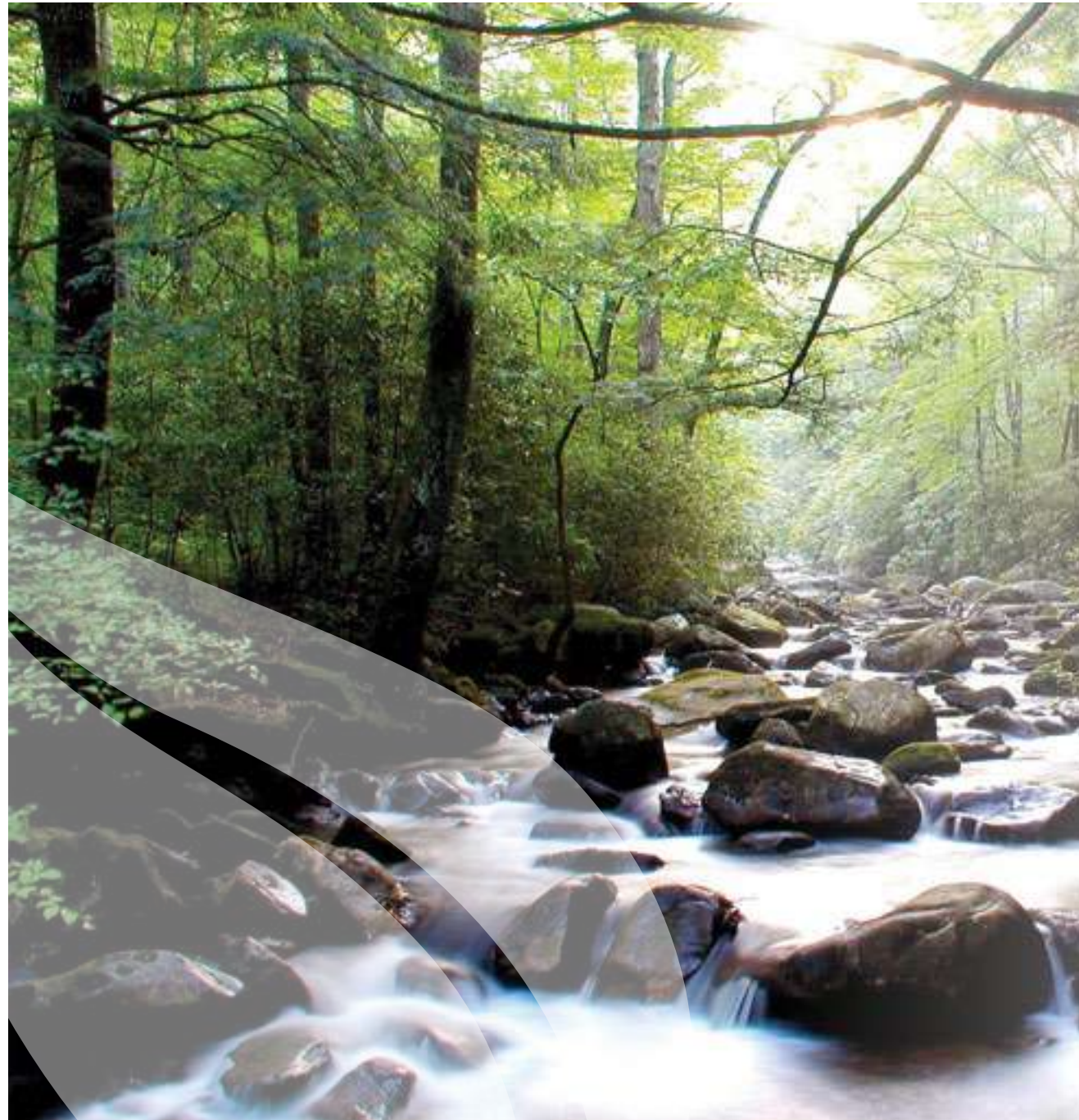

# SUSTAINABLE MANUFACTURING

Kaycan leads the way in the ecologically-conscious manufacturing of quality vinyl and aluminum building products. We have implemented stringent and effective raw materials usage and energy reduction processes in our eleven manufacturing plants, as well as environmentally conscious programs in our distribution centres and corporate offices. These programs and processes have been successful in helping us attain our objectives of reducing waste and energy consumption, and of recycling over 99% of materials in the manufacturing process.

Kaycan is an eco-conscious manufacturer committed to continuing to refine business strategies and activities that meet the needs of the enterprise today, while protecting, sustaining, and enhancing the human and natural resources that will be needed in the future. Kaycan has developed its R3V<sup>®</sup> sustainable manufacturing program with the objective of reducing its ecological footprint by recycling vinyl siding post-consumption at the end of its life cycle.







Kaycan has been manufacturing quality vinyl siding and trims for more than a quarter century. All of our vinyl siding and accessories are formulated with our unique and exclusive Duratron™ vinyl formula that has evolved to become a reference on the market for its durability and fade resistance.

Kaycan's extensive lines of vinyl siding in numerous profiles including traditional double 6" siding, rustic insulated vinyl log siding, and polymer shakes and shingles are designed to enhance any architectural style.

## VINYL SIDING AND TRIMS

Kaycan vinyl siding offers a rainbow of colors as diverse as nature's own. Designed for maximum style, durability, and longevity, our complete trims and accessories lines are the perfect finishing touch for the look you desire.

Whether you are looking for a dramatic architectural flair or subtle accent, Kaycan's complete trims and accessories ensures a custom look and is the perfect finishing touch to any home.

All Kaycan vinyl sidings are supported by a lifetime limited warranty.



## Latest Market Trends

Designers and industry experts predict that the most popular colors for home exteriors are dark, bold colors.

Being at the forefront of the industry, Kaycan's DaVinci line offers the most and darkest colors in the market. Intense heat from the sun's rays can take a toll on the exterior of your home. This can cause panels to distort and fade. Darker colors present an even bigger challenge because they absorb more of the sun's damaging rays.

Kaycan's research and development team aggressively tested dark colored vinyl siding in laboratories and field tests, in order to combat these issues.

The results prove that its unique properties and heat resistance capabilities are ideal for these new color trends.

**HOW HELIOS® WORKS**

Damaging sunrays

Helios® Vinyl Siding

Helios® siding deflects the detrimental rays

**Protects from Heat Distortion**  
HELIOS® thermal diffusion agents protect vinyl siding against distortion caused by heat from the sun.

**PERFORMANCE TEST:**

Heat gun pointed at Kaycan vinyl siding at a temperature of 175.5°F. No distortion from the intense heat.

Heat gun pointed at competitor's siding at a temperature of 176.5°F. Siding tends to deform in the heat.

**COLORFAST™ WILL PROTECT YOUR HOME FROM FADING.**

Partnering with a world leader in acrylic technology, Kaycan has developed a process to fuse a protective acrylic layer to a vinyl base. The colored acrylic layer resists the harmful effect of the sun's ultraviolet rays that cause fading. The vinyl base provides strength and durability for long-term performance.

**25 YEARS**

After only a few months, you can easily see the damage the sun could do to average vinyl siding if it came in a dark color. It's easy to see the difference. Colorfast™ technology makes.



## RICHMOND

## RICHMOND ULTRA

VINYL SIDING AND TRIMS

### Richmond™

The time-honoured tradition of Double 6" siding manufactured in ultra durable vinyl. Classic beauty and long lasting elegance in a subtle realistic woodgrain available in rich heritage colors and perfectly matched trims.

- Premium thickness of 0.050" for outstanding impact resistance.
- Double-thick nail hem for extra rigidity and wind resistance.
- 25 year fade resistance warranty.
- Richmond is covered by a lifetime limited warranty.



Richmond - Cobalt

#### D6 Richmond Panel

**Product code: 0086**  
100 sq ft/CTN  
9 panels/CTN  
Length: 12'

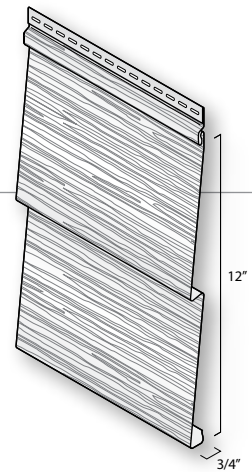

#### Kaylok Aluminum Starter Trim

**Product Code: 108200**  
500 ft/CTN  
50 pcs/CTN  
Length: 10'

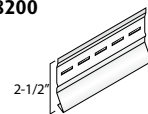

#### 3/4" J Trim

**Product code: VJG034**  
500 ft/CTN  
40 pcs/CTN  
Length: 12'-6"

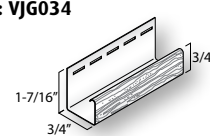

#### 3-1/2" Outside Corner

**Product code: VCMNN3**  
100 ft/CTN  
10 pcs/CTN  
Length: 10'

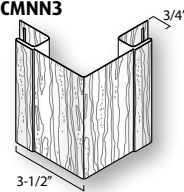

#### 3/4" Inside Corner

**Product code: VCGINP**  
100 ft/CTN  
10 pcs/CTN  
Length: 10'

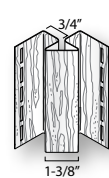

### Richmond™ Ultra Insulated Wall System

Classic style, exceptional toughness. The heritage look and characteristics of Richmond Double 6" siding with the strength, ultra-impact resistance and added comfort of an insulated wall system.

- Precisely contoured shield integrated backing system provides 300% more impact resistance.
- Reduces noise level by 30%, and keeps homes warmer in the winter and cooler in the summer.

#### Richmond Ultra

**Product code: 0026**  
100 sq ft/CTN  
9 pcs/CTN  
Length: 12'

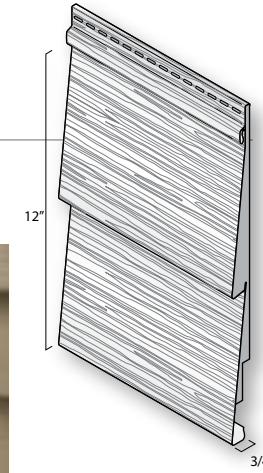

#### 4" Corner Post Insulating Foam

**Product code: 067500**  
156 ft/CTN  
39 pcs/CTN  
Length: 48"

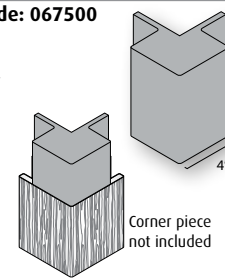

#### 1-1/4" J Trim

**Product code: 1045**  
288 ft/CTN  
24 pcs/CTN  
Length: 12'

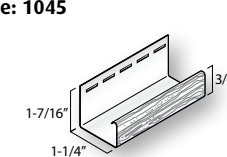

#### 4" Outside Corner

**Product code: 1104**  
60 ft/CTN  
6 pcs/CTN  
Length: 10'

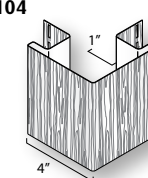

#### Insulated Steel Starter Strip

**Product Code: 101100**  
250 ft/CTN  
25 pcs/CTN  
Length: 10'

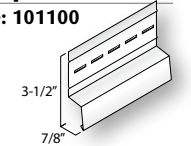

Consult your local Kaycan distribution centre for product availability



Richmond Ultra - Sandalwood

VINYL SIDING AND TRIMS

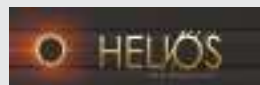

- D6 Richmond White
- D6 Richmond Spice
- D6 Richmond Cobalt
- D6 Richmond Pecan
- D6 Richmond Charcoal
- D6 Richmond Umber
- D6 Richmond Brick
- D6 Richmond Evergreen
- D6 Richmond Khaki

- Richmond Ultra Beige
- Richmond Ultra Linen
- Richmond Ultra Willow
- Richmond Ultra Slate Grey
- Richmond Ultra Khaki
- Richmond Ultra Mocha
- Richmond Ultra Sandalwood
- Richmond Ultra White



## OCEAN PARK XL



Ocean Park XL - Sandalwood



VINYL SIDING AND TRIMS

### Ocean Park XL™

Enduring splendor through unconditional performance. Ocean Park XL's heavy-duty panels and low-gloss finish provide the natural look of painted wood lasting for years with low maintenance.

- Ocean Park XL's double nail hem designs ensures a sturdy application
- Extra thick panels for unmatched rigidity and straighter walls.
- Ocean Park XL's 16' panels reduce seams by 33% compared to standard siding.

**D4.5 Ocean Park XL**  
Product code: 0120  
200 sq ft/CTN  
16 panels/CTN  
Length: 16'8"

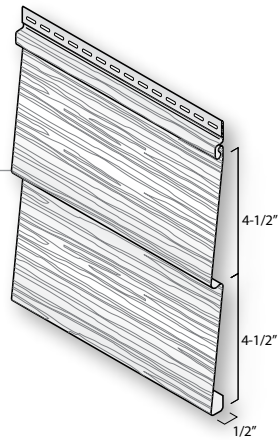

**D4.5D Ocean Park XL Dutch Lap**  
Product code: 0122  
200 sq ft/CTN  
16 panels/CTN  
Length: 16'8"

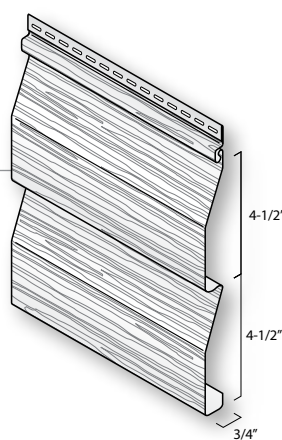

**7/8" J Trim**  
Product code: 1038  
480 ft/CTN  
40 pcs/CTN  
Length: 12'

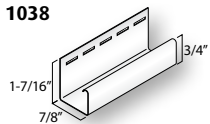

**4" Outside Corner**  
Product code: 1104  
60 ft/CTN  
6 pcs/CTN  
Length: 10'

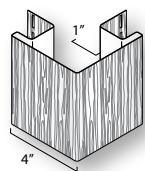

### Ocean Park XL™ Ultra [Insulated Wall System]

The winning combination of Ocean Park XL's durability and elegance with the impact resistance and added insulation value of a contoured backing system.

- Precisely contoured backing system for ultra-impact resistance.
- System R-value of 5.0 provides 4 times the insulating value of regular siding.
- Reduces noise level by 45%, and keeps homes warmer in the winter and cooler in the summer.

Note: The Ocean Park XL Ultra product is the combination of the regular Ocean Park XL Dutch Lap siding with the Ocean Park XL Dutch Lap foam. The Contoured foam is sold separately.

#### Ocean Park XL Ultra Dutch Lap Foam

Product code: 067200  
12 pcs/CTN  
18" high by 64" long foam panel  
Siding Panels not included

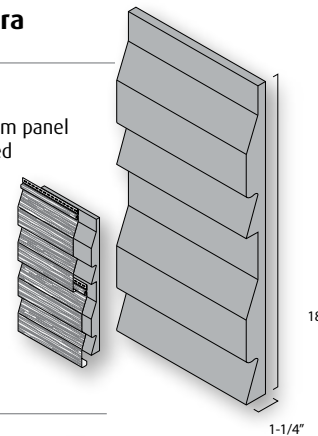

#### 4" Outside Corner

Product code: 1104  
60 ft/CTN  
6 pcs/CTN  
Length: 10'

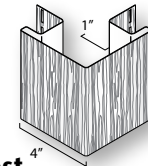

#### 4" Corner Post Insulating Foam

Product code: 067500  
156 ft/CTN  
39 pcs/CTN  
Length: 48"

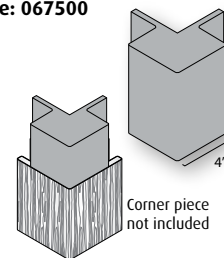

#### Insulated Vinyl Starter Strip

Product Code: 104900  
288 ft/CTN  
24 pcs/CTN  
Length: 12'

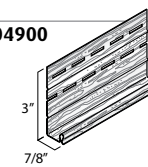

#### Insulated Steel Starter Strip

Product Code: 101100  
250 ft/CTN  
25 pcs/CTN  
Length: 10'

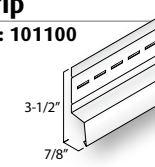

#### 1-1/4" J Trim

Product code: 1045  
288 ft/CTN  
24 pcs/CTN  
Length: 12'

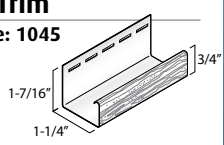

Consult your local Kaycan distribution centre for product availability

### Ocean Park XL - Mocha



VINYL SIDING AND TRIMS

Ocean Park XL Khaki

Ocean Park XL Linen

Ocean Park XL Beige

Ocean Park XL Mocha

Ocean Park XL Sage

Ocean Park XL Sandalwood

Ocean Park XL Slate Grey

Ocean Park XL Flagstone

Ocean Park XL Willow Green

Ocean Park XL Terraverde

Ocean Park XL Ivory

Ocean Park XL White



## DAVINCI

### DaVinci™

Enrich your home with deep lasting colors reflecting the latest design trends. DaVinci provides a distinctively dramatic style with its rainbow of dark, rich hues that will endure through years.

- Exclusive Colorfast™ formulation prevents fading, yellowing and heat retention.
- Premium 0.046" thickness for added impact resistance.



DaVinci - Cabot Blue



DaVinci - Manor

#### D4D DaVinci Dutch Lap

**Product code: 0062**  
200 sq ft/CTN  
24 panels/CTN  
Length: 12'-6"

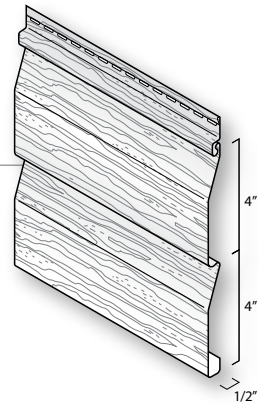

#### D4 DaVinci Panel

**Product code: 0061**  
200 sq ft / CTN  
24 panels / CTN  
Length: 12'-6"

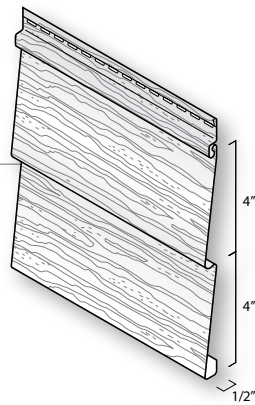

#### DaVinci Board and Batten

**Product code: 0259**  
100 sq ft/CTN  
17 panels/CTN  
Length: 10'

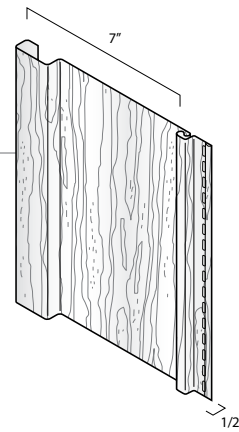

#### 1/2" Inside Corner

**Product code: VCBINP**  
100 ft/CTN  
10 pcs/CTN  
Length: 10'

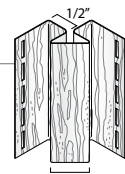

#### Undersill Trim

**Product code: 1064**  
288 ft/CTN  
24 pcs/CTN  
Length: 12'

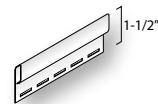

#### 5/8" J-Trim

**Product code: 1034**  
480 ft/CTN  
40 pcs/CTN  
Length: 12'

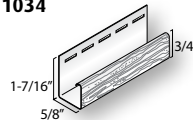

#### 3" Outside Corner

**Product code: 1098**  
100 ft/CTN  
10 pcs/CTN  
Length: 10'

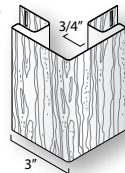

#### D4.5 DaVinci Dutch Lap

**Product code: 0069**  
198 sq ft/CTN  
22 panels/CTN  
Length: 12'

Available only in Manitoba, Saskatchewan, Alberta and British Columbia

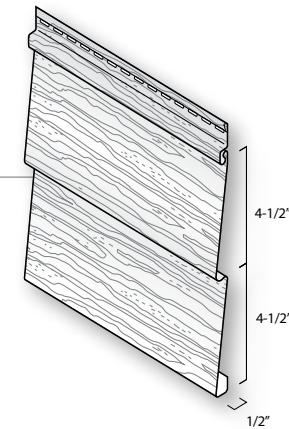

#### D4.5D DaVinci Dutch Lap

**Product code: 0029**  
198 sq ft/CTN  
22 panels/CTN  
Length: 12'

Available only in Manitoba, Saskatchewan, Alberta and British Columbia

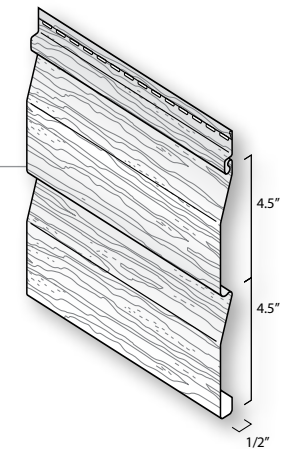

Consult your local Kaycan distribution centre for product availability

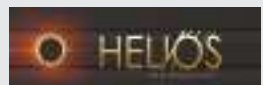

DaVinci Dutch Lap Colonial Red

DaVinci Dutch Lap Midnight blue

DaVinci Dutch Lap Cabot Red

DaVinci Dutch Lap Cabot Brown

DaVinci Dutch Lap Cabot Blue

DaVinci Dutch Lap Mahogany

DaVinci Dutch Lap Spice

DaVinci Dutch Lap Pecan

DaVinci Dutch Lap Ivy Green

DaVinci Dutch Lap Castlemore

DaVinci Dutch Lap Manor



## VERONA

VINYL SIDING AND TRIMS

VINYL SIDING AND TRIMS

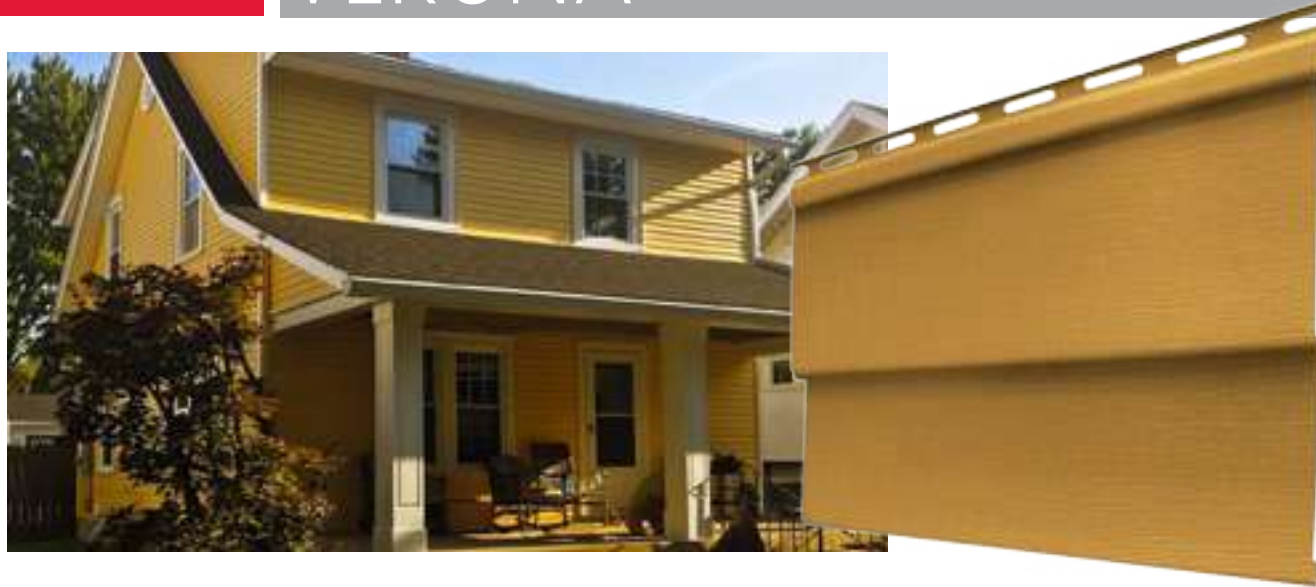

### Verona™

This stunning, vibrant color palette, was carefully selected by our design team alongside architects; these bold colors will be trending throughout the year. The pop of color offered by our Verona Collection will surely grab attention!

- Exclusive Helios™ Technology protects dark color siding against distortion caused by the sun's intense heat.
- Premium gauge thickness for added impact resistance.
- Duratron Vinyl Technology ensures durability and long lasting performance.



Verona - Urban Blue

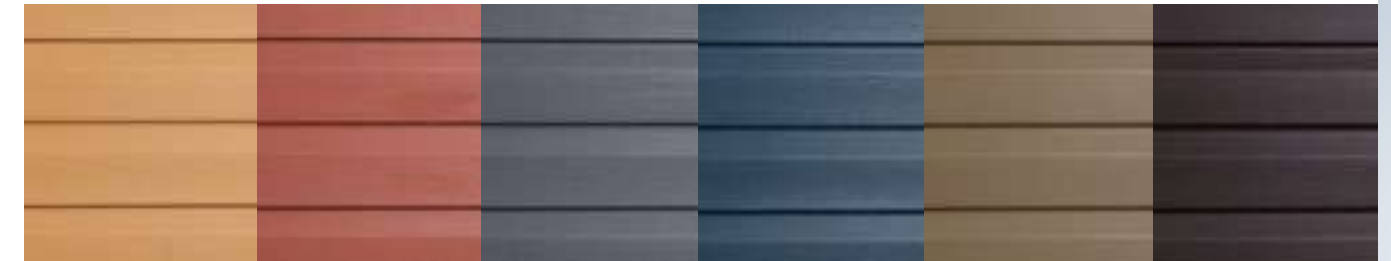

## BOLD VIVID COLORS



### D4D Verona Dutch Lap

Product code: 0126  
200 sq ft/CTN  
24 panels/CTN  
Length: 12'-6"

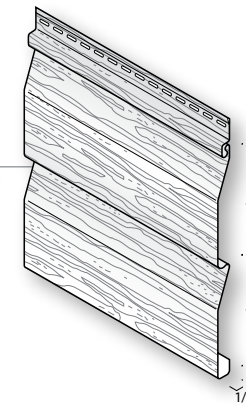

### D4 Verona Panel

Product code: 0125  
200 sq ft / CTN  
24 panels / CTN  
Length: 12'-6"

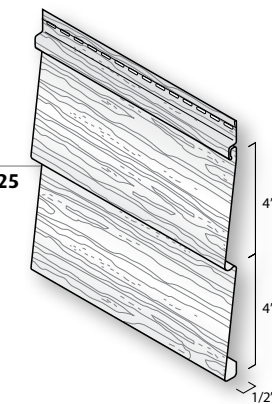

### 1/2" Inside Corner

Product code: VCBINP  
100 ft/CTN  
10 pcs/CTN  
Length: 10'

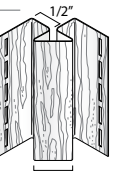

### 3" Outside Corner

Product code: VCNN3  
100 ft/CTN  
10 pcs/CTN  
Length: 10'



### 5/8" J-Trim

Product code: VJB58  
480 ft/CTN  
40 pcs/CTN  
Length: 12'

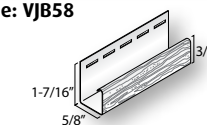

### Undersill Trim

Product code: VTUTB  
288 ft/CTN  
24 pcs/CTN  
Length: 12'

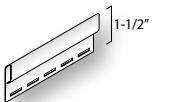

Verona - Urban Blue



Verona D4 Golden Honey

Verona D4 Autumn Harvest

Verona D4 Boulder Gray

Verona D4 Urban Blue

Verona D4 Tundra

Verona D4 Java Brown



## HARDWOOD VALLEY II

## MONTEBELLO

VINYL SIDING AND TRIMS

VINYL SIDING AND TRIMS

### Hardwood Valley™ II

The charm of antiqued barnwood. With its variegated color blend, Hardwood Valley II offers the distinctive look of weathered boards adding warmth and character to any home.

- Lasting natural aged wood colors.
- Premium 0.044" thickness for added rigidity and sturdiness.



Hardwood Valley II  
River Rock



### Montebello™ Vinyl Log Siding

The rustic look of log siding without the maintenance. Montebello captures the distinctive beauty and warmth of real log siding and the weatherability and durability of vinyl siding in an insulated wall system that adds impact resistance and comfort to your home.

- Deeply textured woodgrain of hand-stained cedar is formed from real cedar logs.



Montebello  
Spice

**D5D Hardwood Valley II Dutch Lap**  
Product code: VKND5C  
200 sq ft/CTN  
20 panels/CTN  
Length: 12'

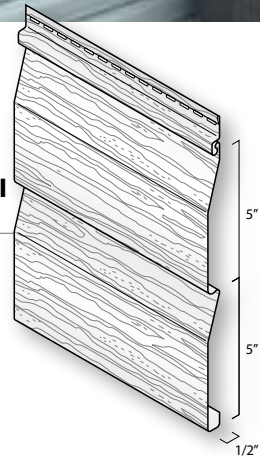

**D4 Hardwood Valley II**  
Product code: VKND40  
200 sq ft/CTN  
24 panels/CTN  
Length: 12'-6"

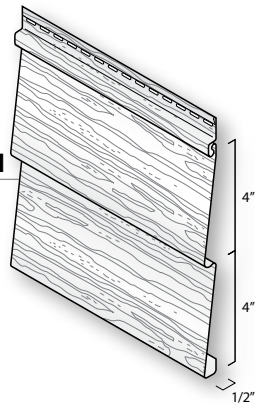

**3" Outside Corner Hardwood Valley II**  
Product code: VCNN3  
100 ft/CTN  
10 pcs/CTN  
Length: 10'

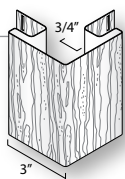

**1/2" Inside Corner Hardwood Valley II**  
Product code: VCBINP  
100 ft/CTN  
10 pcs/CTN  
Length: 10'

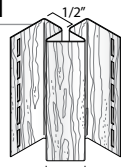

**Undersill Trim Hardwood Valley II**  
Product code: VTUTB  
500 ft/CTN  
50 pcs/CTN  
Length: 10'

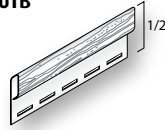

**5/8" J-Trim Hardwood Valley II**  
Product code: VJB558  
500 ft/CTN  
40 pcs/CTN  
Length: 12'-6"

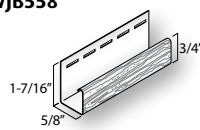

**7" Montebello Vinyl Log Siding**  
Product code: VADILS  
100 sq ft/CTN  
14 panels/CTN  
Length: 11.92'

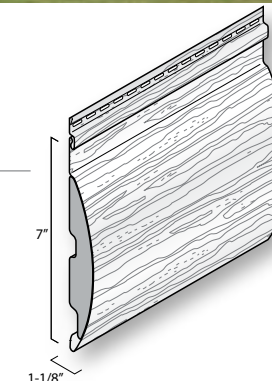

**Kaylok Steel Starter Trim**  
Product code: 108300  
300 ft/CTN  
30 pcs/CTN  
Length: 10'

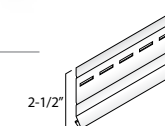

**4" Outside Corner**  
Product code: VCNN4  
60 ft/CTN  
6 pcs/CTN  
Length: 10'

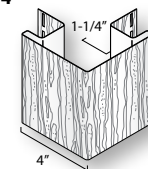

**1-1/4" J Trim**  
Product code: VJB1251F  
480 ft/CTN  
40 pcs/CTN  
Length: 12'

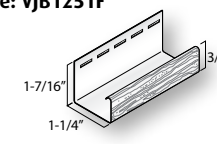

Consult your local Kaycan distribution centre for product availability

- Hardwood Valley II D4 Panel Vermont Maple
- Hardwood Valley II D4 Panel Natural Oak
- Hardwood Valley II D4 Panel Cypress
- Hardwood Valley II D4 Panel Cherry
- Hardwood Valley II D4 Panel Weathered Wood
- Hardwood Valley II D4 Panel River Rock

- Montebello Log Siding Cypress
- Montebello Log Siding Vermont Maple
- Montebello Log Siding River Rock
- Montebello Log Siding Spice



## TIMBERLAKE



### Timberlake™

Timberlake's authentic woodgrain and low-gloss finish is available in one of the widest color palettes on the market. Timberlake's distinctive style gives your home a classic look with great curb appeal.

- Subtle texture and low gloss finish.
- Premium 0.044" thickness for long lasting durability.

#### D5D Elegance Dutch Lap

**Product code: 0015**  
200 sq ft/CTN  
20 panels/CTN  
Length: 12'

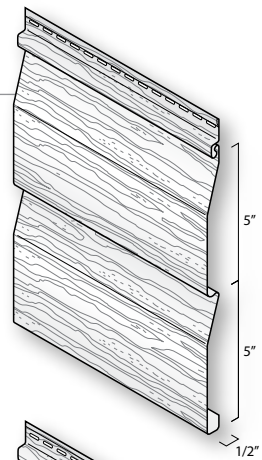

#### T3D Classic Dutch Lap

**Product code: 0064**  
198 sq ft/CTN  
22 panels/CTN  
Length: 12'

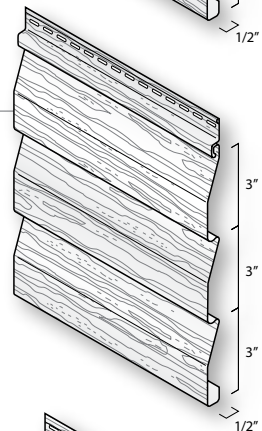

#### D5 Contessa

**Product code: 0049**  
200 sq ft/CTN  
20 panels/CTN  
Length: 12'  
\* Special order only.

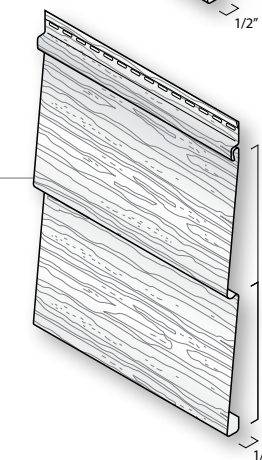

#### D4D Avanti Dutch Lap

**Product code: 0063**  
200 sq ft/CTN  
24 panels/CTN  
Length: 12'-6"

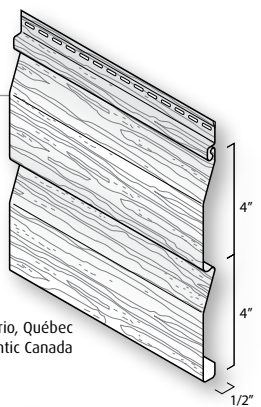

Available only in Ontario, Québec and Atlantic Canada

#### D4 Marquis

**Product code: 0052**  
200 sq ft/CTN  
24 panels/CTN  
Length: 12'-6"

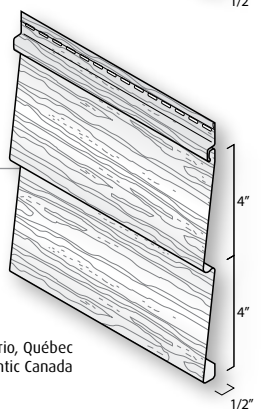

Available only in Ontario, Québec and Atlantic Canada

#### D4.5D Sierra Dutch Lap

**Product code: 0012**  
198 sq ft/CTN  
22 panels/CTN  
Length: 12'

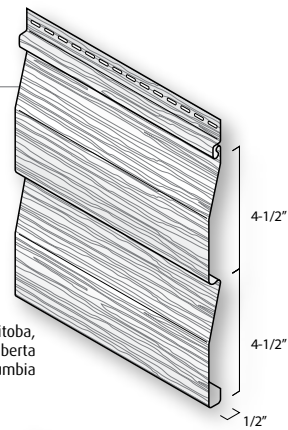

Available only in Manitoba, Saskatchewan, Alberta and British Columbia

#### D4.5 Lewiston

**Product code: 0053**  
198 sq ft/CTN  
22 panels/CTN  
Length: 12'

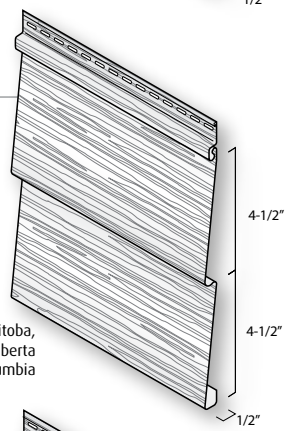

Available only in Manitoba, Saskatchewan, Alberta and British Columbia

#### T3 Woodgrain

**Product code: 0048**  
198 sq ft/CTN  
22 panels/CTN  
Length: 12'

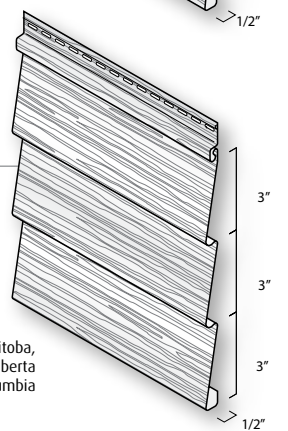

Available only in Manitoba, Saskatchewan, Alberta and British Columbia



Timberlake sidings are available in one of the widest color palettes on the market. Only a selection of colors is shown here, please contact your Kaycan sales representative to see the complete color selection and availability in your market.

D5 Contessa Ivory

D5D Elegance Dutch Lap Mocha

T3D Classic Dutch Lap Wicker

D4D Avanti Dutch Lap Azure Blue

D4 Marquis Linen White

D4.5D Sierra Dutch Lap Bisque

T3 Woodgrain Flagstone

D4.5 Lewiston Slate Grey



## VERTICAL

## PROVA

### Vertical

Kaycan's Board and Batten and Vertical D5 siding provides distinct shadow lines of the traditional Board and Batten, or the look of tongue and groove cedar planks to your home.

- Available in both smooth and woodgrain finishes.
- Low gloss finish creates the looks of freshly painted wood.



Vertical Board and Batten - Khaki



### Board and Batten Wood Grain

**Product code: 0251**  
100 sq ft/CTN  
17 panels/CTN  
Length: 10'

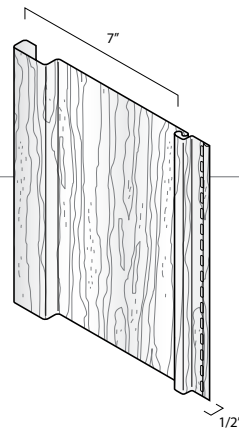

### D5 Vertical Vinyl Siding

**Product code: 0235**  
200 sq ft/CTN  
24 panels/CTN  
Length: 10'

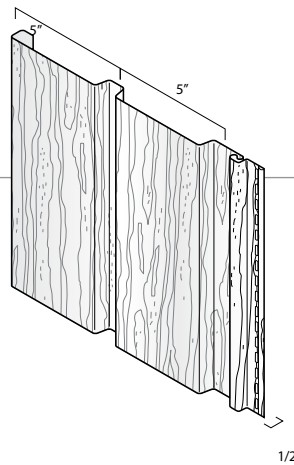

### Prova™

Prova provides all of the advantages of vinyl siding in a Double 4.5" Dutch lap profile available in a wide color palette.

- Low gloss woodgrain finish.
- Manufactured with Kaycan's exclusive Duratron™ formula
- Standard thickness for impact resistance and durability.
- Available in an array of designer colors

### D4.5D Prova

**Product code: 0011**  
198 sq ft/CTN  
22 panels/CTN  
Length: 12'

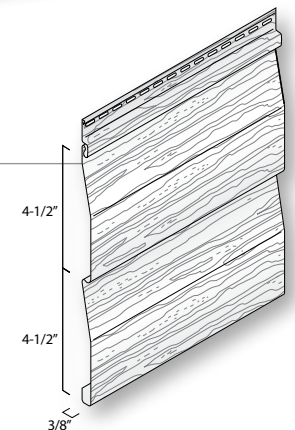

Consult your local Kaycan distribution centre for product availability

D5 Vertical Khaki



Board and Batten Mocha

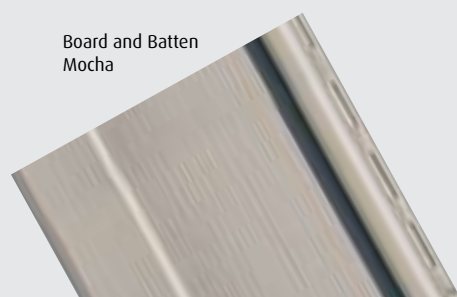

D4.5D Prova Beige





## PERFECTION SHINGLES

## PERFECTION SHINGLES

VINYL SIDING AND TRIMS

VINYL SIDING AND TRIMS

### Perfection Shingles

Perfection Shingles will not crack, rot or warp. The simple lines, historic style and natural beauty all enhance the exterior of your home. With minimal maintenance, this siding will provide years of beauty and elegance to your home's exterior.

- Available in an array of warm earth tones and modern vibrant colors.



Perfection Shingles - Nutmeg



### Perfection Single 7"

**Product code: 9617**  
50 sq ft/CTN  
14 panels/CTN  
Length: 6'



### Perfection Double 7"

**Product code: 9616**  
50 sq ft/CTN  
11 panels/CTN  
Length: 4'



### Perfection Corner

**Product code: 9638**  
5 pcs/CTN  
Length: 28"

### Perfection Starter

**Product code: 101800**  
25 pcs/CTN  
Length: 10'



Unique temperature lines molded directly on the panel ensuring fast and accurate installation.

Special structural ribs for added stability and extra protection against warping and distortion.

Easy Lock system enables installation under a window or at the end of a wall without tilting the panel.

Perimeter locks create a seamless look and hold the panels securely together.

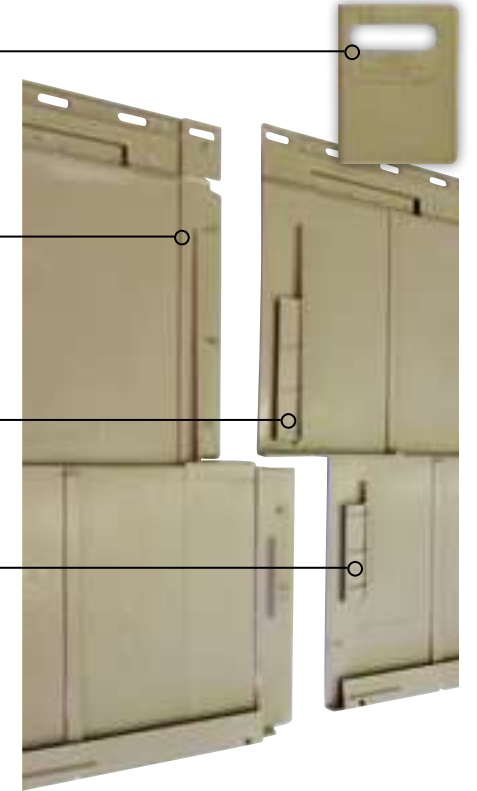

### Perfection Shingles Color Offering



\*Color not available in Single 7"

Consult your local Kaycan distribution centre for product availability



## VINYL SOFFIT

### Vinyl Soffit

Kaycan vinyl soffit gives your home a finished look and virtually eliminates maintenance in those hard-to-reach areas, like under eaves and over porches.

- The beauty of painted wood.
- The durability and low maintenance of vinyl.
- Woodgrain or smooth with a low-gloss finish.



16" Vented 4-panel Soffit - White

#### Vented Double 5 Soffit

**Product code: 0615**  
200 sq ft/CTN  
20 panels/CTN  
Length: 12'

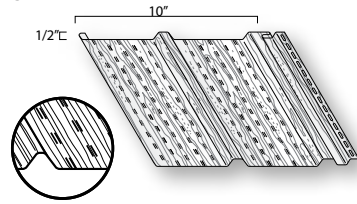

#### Solid Double 5 Soffit

**Product code: 0616**  
200 sq ft/CTN  
20 panels/CTN  
Length: 12'

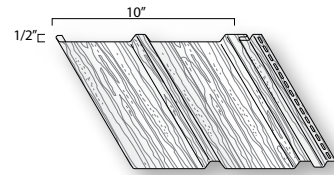

#### Solid Beaded Soffit

**Product code: 0634**  
100 sq ft/CTN  
12 panels/CTN  
Length: 12' 6"

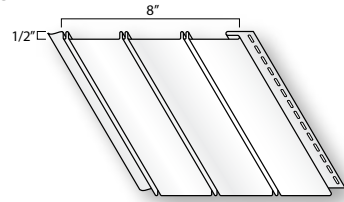

#### Triple 4 Full-O-Vent

**Product code: 0622**  
192 sq ft/CTN  
16 panels/CTN  
Length: 12'

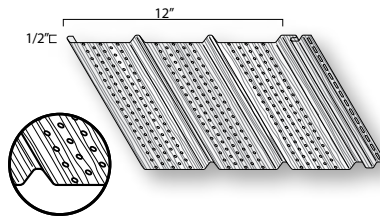

#### Vented Beaded Soffit

**Product code: 0635**  
100 sq ft/CTN  
12 panels/CTN  
Length: 12' 6"

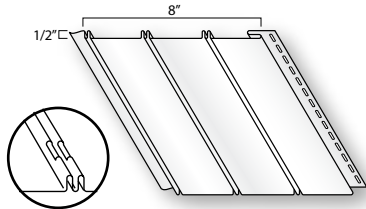

#### 8" Vented 2-panel Soffit

**Product code: 0619**  
192 sq ft/CTN  
24 panels/CTN  
Length: 12'

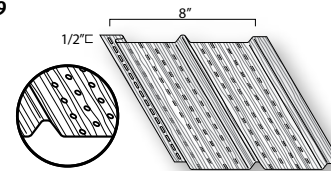

Available only in Manitoba, Saskatchewan, Alberta and British Columbia

#### 8" Solid 2-panel Soffit

**Product code: 0621**  
192 sq ft/CTN  
24 panels/CTN  
Length: 12'

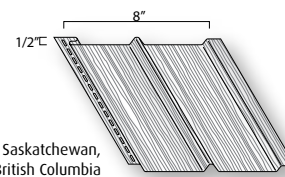

Available only in Manitoba, Saskatchewan, Alberta and British Columbia

#### 16" O-vent 4-panel Soffit

**Product code: 061725**  
192 sq ft/CTN  
12 panels/CTN  
Length: 12'

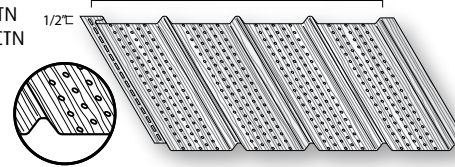

Available only in Manitoba, Saskatchewan, Alberta and British Columbia

#### 16" Vented 4-panel Soffit

**Product code: 0617**  
192 sq ft/CTN  
12 panels/CTN  
Length: 12'

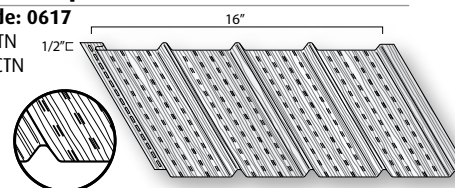

Available only in Ontario, Quebec and Atlantic Canada

#### 16" Solid 4-panel Soffit

**Product code: 0618**  
192 sq ft/CTN  
12 panels/CTN  
Length: 12'

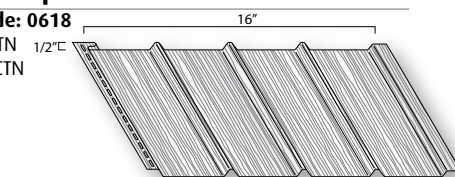

16" Solid 4-panel Soffit - Lined White



Solid Double 5 Sandalwood

Solid Triple 3 Beige

16" Solid 4-panel Mocha

Vinyl Soffit Beaded Linen white

Double 5 Vented Slate Grey

16" Vented 4-panel Soffit Linen White

Triple 3 Full-O-Vent White

16" O-Vent 4-panel Soffit White



## VINYL SIDING TRIMS

### Vinyl Siding Trims

Architectural expression through infinite trim and accessory options. Whether to transform an ordinary outside corner into a distinctive design element, to protect your walls from water infiltration or to add a decorative accent, Kaycan Premium Vinyl Trims can add form and function to your home.

- Manufactured with Kaycan's exclusive Duratron™ vinyl formula same as Kaycan vinyl sidings.

- Available in a wide palette of colors.

**2" Outside Corner**  
**Product code: 1109**  
 140 ft/CTN  
 14 pcs/CTN  
 Length: 10'

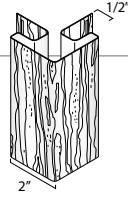

**3" Outside Corner**  
**Product code: 1105**  
 100 ft/CTN  
 10 pcs/CTN  
 Length: 10'

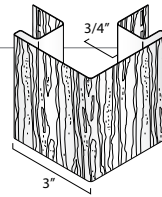

**Inside Corner**  
**Product code: 1115**  
 240 ft/CTN  
 24 pcs/CTN  
 Length: 10'

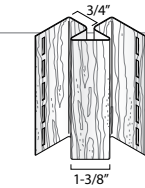

**Undersill Trim**  
**Product code: 1066**  
 288 ft/CTN  
 24 pcs/CTN  
 Length: 12'

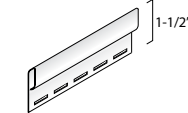

**Dual Undersill Trim**  
**Product code: VT2DUT**  
 300 ft/CTN  
 25 pcs/CTN  
 Length: 12'

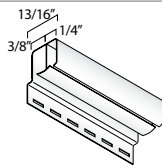

**3/4" J Trim**  
**Product code: VJM034**  
 480 ft/CTN  
 40 pcs/CTN  
 Length: 12'

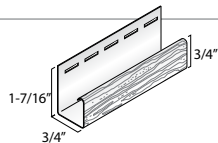

**1/2" J Trim**  
**Product code: 1033**  
 480 ft/CTN  
 40 pcs/CTN  
 Length: 12'

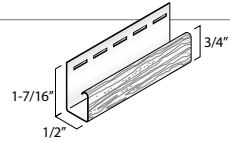

**5/8" J Trim**  
**Product code: 1035**  
 480 ft/CTN  
 40 pcs/CTN  
 Length: 12'

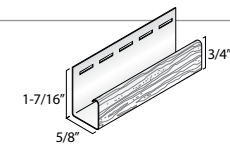

**7/8" J Trim**  
**Product code: 1038**  
 480 ft/CTN  
 40 pcs/CTN  
 Length: 12'

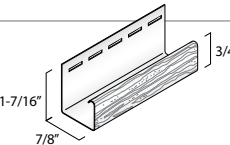

**Wide Face J Trim**  
**Product code: 1048**  
 480 ft/CTN  
 40 pcs/CTN  
 Length: 12'

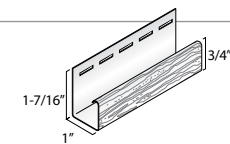

**1-1/4" J Trim**  
**Product code: 1045**  
 288 ft/CTN  
 24 pcs/CTN  
 Length: 12'

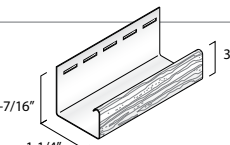

**1-5/8" J Trim**  
**Product code: 1059**  
 288 ft/CTN  
 24 pcs/CTN  
 Length: 12'  
 (Available in White only)

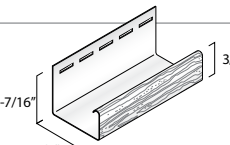

**Drip Cap**  
**Product code: 1185**  
 288 ft/CTN  
 24 pcs/CTN  
 Length: 12'

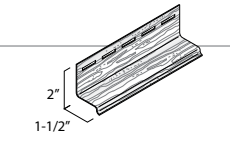

**Vertical Base Trim**  
**Product code: 1175**  
 288 ft/CTN  
 24 pcs/CTN  
 Length: 12'

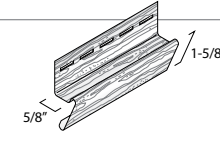

**Vinyl Starter Trim**  
**Product code: 1085**  
 288 ft/CTN  
 24 pcs/CTN  
 Length: 12'

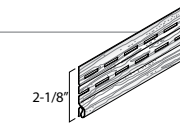

**Kaylok Aluminum Starter Trim**  
**Product code: 108200**  
 500 ft/CTN  
 50 pcs/CTN  
 Length: 10'

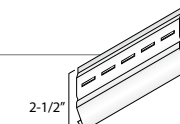

**Kaylok Steel Starter Trim**  
**Product code: 108300**  
 300 ft/CTN  
 30 pcs/CTN  
 Length: 10'

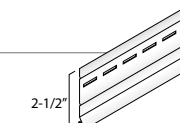

**Wideface Steel Starter Trim**  
**Product code: 109000**  
 300 ft/CTN  
 30 pcs/CTN  
 Length: 10'

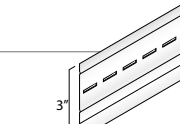

**Insulated Steel Starter Strip**  
**Product Code: 101100**  
 250 ft/CTN  
 25 pcs/CTN  
 Length: 10'

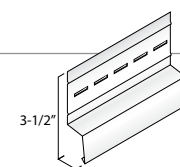

**Insulated Vinyl Starter Strip**  
**Product code: 104900**  
 288 ft/CTN  
 24 pcs/CTN  
 Length: 12'

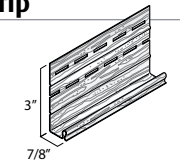

**WeatherStrong Aluminum Starter Trim**  
**Product code: 108700**  
 500 ft/CTN  
 50 pcs/CTN  
 Length: 10'

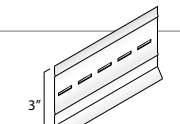

Used with Prova siding

**Anti-Rodent Trim Vinyl**  
**Product code: 711000**  
 163 ft/CTN  
 20 pcs/CTN  
 Length: 8' 2" 1-7/8"

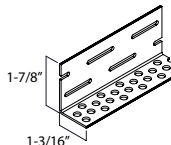



## VINYL SIDING TRIMS

## VINYL SOFFIT TRIMS

### Double Channel 3-1/2"

**Product code: 106201**  
240 ft/CTN  
12 pcs/CTN  
Length: 20'

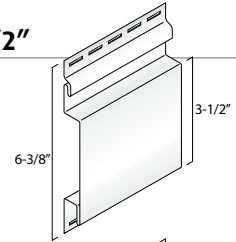

### Double Channel 6"

**Product code: 106301**  
320 ft/CTN  
16 pcs/CTN  
Length: 20'

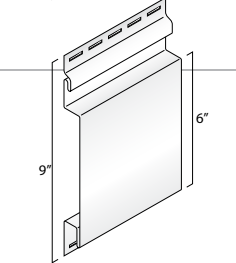

### 6" Designer (fluted) Outside Corner

**Product code: 1107**  
200 ft/CTN  
10 pcs/CTN  
Length: 20'

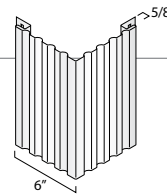

### 6" Insulated Designer (fluted) Outside Corner

**Product code: 1132**  
100 ft/CTN  
5 pcs/CTN  
Length: 20'

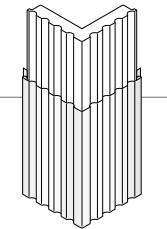

6" Designer Outside Corner and insulated contoured foam included with this code

### 6" Traditional Outside Corner

**Product code: 1252**  
10 pcs/CTN  
Length: 20'

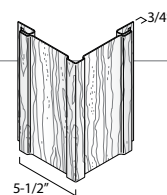

### 6" Insulated Traditional Outside Corner

**Product code: 1253**  
100 ft/CTN  
5 pcs/CTN  
Length: 20'

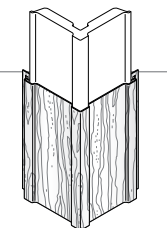

6" Traditional Outside Corner and insulated contoured foam included with this code

### Super J Trim Window/Door Casing

**Product code: 1056**  
144 ft/CTN  
12 pcs/CTN  
Length: 12'

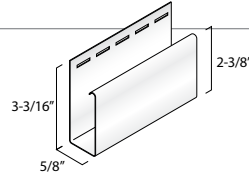

### 1-1/2" Deep Pocket J Trim

**Product code: 1030**  
216 ft/CTN  
18 pcs/CTN  
Length: 12'

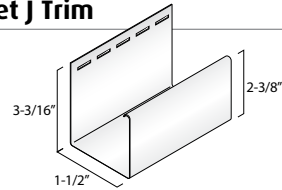

### 3-1/2" Window Surround

**Product code: 1052**  
432 ft/CTN  
36 pcs/CTN  
Length: 12'

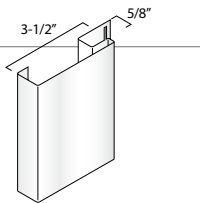

### 5" Window Surround

**Product code: 1055**  
288 ft/CTN  
24 pcs/CTN  
Length: 12'

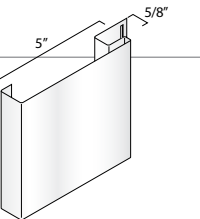

### Window Starter Trim

**Product code: 1054**  
288 ft/CTN  
24 pcs/CTN  
Length: 12'

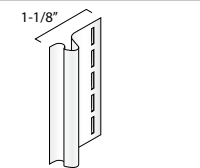

### 5/8" Flexible J Trim

**Product code: 2095**  
216 ft/CTN  
18 pcs/CTN  
Length: 12'

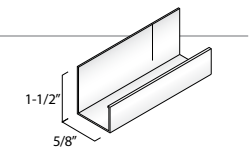

### Bay/Bow Outside Corner Trim

**Product code: 117401**  
200 ft/CTN  
20 pcs/CTN  
Length: 10'

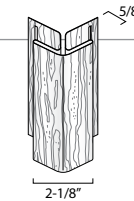

### Bay/Bow Inside Corner Trim

**Product code: 117301**  
200 ft/CTN  
20 pcs/CTN  
Length: 10'

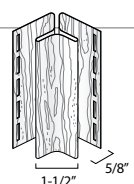

### Frieze Receptacle

**Product code: VTFBR**  
576 ft/CTN  
48 pcs/CTN  
Length: 12'

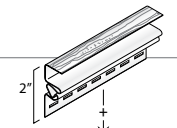

### Snap-In Crown Mold

**Product code: VTCMD**  
576 ft/CTN  
48 pcs/CTN  
Length: 12'

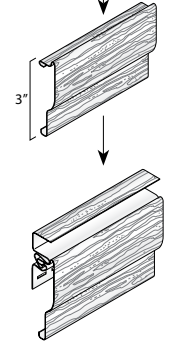

### H Trim

**Product code: 1179**  
144 ft/CTN  
12 pcs/CTN  
Length: 12'

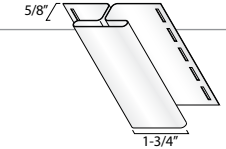

### F Trim

**Product code: 1178**  
336 ft/CTN  
28 pcs/CTN  
Length: 12'

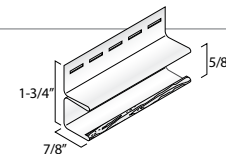

### 8" Vinyl Fascia (with integrated J trim)

**Product code: 0490**  
157 ft/CTN  
16 pcs/CTN  
Length: 9'-10"

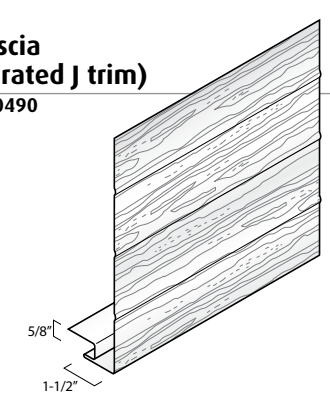
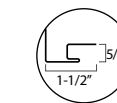



## INTERIOR SIDING

## VINYL SKIRTING

### I-Span - Polymeric Interior Wall & Ceiling Liner System

When maintaining the highest level of cleanliness is a priority, I-Span Polymeric Interior Wall & Ceiling Liner System is the clear choice.

- Resistant to chemicals & moisture.
- Light weight, easy install.
- Perfect for dairy / hog barns, car washes, vet clinics, industrial kitchens & agriculture growth operations.
- Available lengths 10', 12' & 16'



• **I-Span Panel 12" x 10'**  
(White)  
Product code: VDSWC121001

• **I-Span Panel 12" x 12'**  
(White)  
Product code: VDSWC121201

• **I-Span Panel 12" x 16'**  
(White)  
Product code: VDSWC121601

Special lengths available upon request with minimum quantity



**Universal Corner**  
Product code: VCISP01  
10 pcs/Box  
Length: 10'

**H-Trim**  
Product code: 326301  
20 pcs/Box  
Length: 10'



**J-Trim**  
Product code: 326401  
20 pcs/Box  
Length: 10'

**Base Trim**  
Product code: VBISP01  
20 pcs/Box  
Length: 10'



**3/8 Inside Cove**  
Product code: VICISP01  
25 pcs/Box  
Length: 10'



### Vinyl Skirting

A clean and professional look for porch enclosures, foundation surrounds and skirting for manufactured housing. Solid panels can be interspersed with vented panels to provide necessary air exchange beneath the home.

- Sanitary and easy to clean.
- Insect and vermin resistant.
- Easy to install.

### AgriTUFF™

AgriTUFF panel system is the premier choice for the interiors of commercial, industrial and agricultural facilities. AgriTUFF's durable finish safeguards against harsh elements.

- Wall and ceiling systems are easily maintained.

#### 5/8" J Trim

Product code: 1035  
480 ft/CTN  
40 pcs/CTN  
Length: 12'

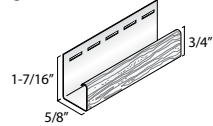

#### Board and Batten AgriTUFF, matte finished

Product code: 9996  
Special lengths only\*

\* Minimum order required for a production run is 100 squares per length.

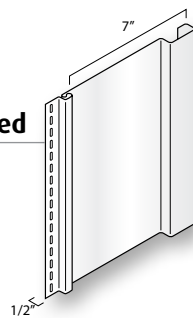

#### Double 5 AgriTUFF - 10" vertical wood grain

Product code: 9994  
Special lengths only\*

\* Minimum order required for a production run is 100 squares per length.

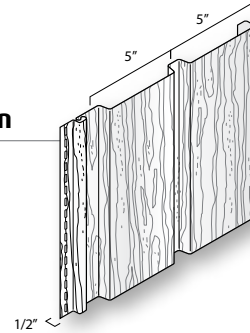

#### H Trim

Product code: 1179  
144 ft/CTN  
12 pcs/CTN  
Length: 12'

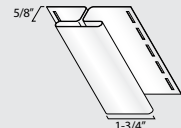

#### Triple 4 AgriTUFF - 12" vertical brushed

Product code: 9998  
Special lengths only\*

\* Minimum order required for a production run is 100 squares per length.

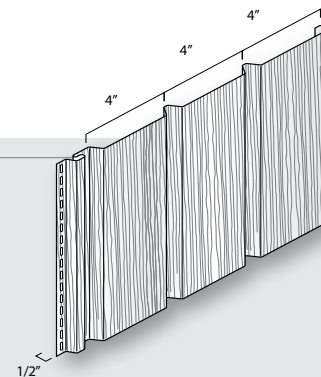

#### Triple 4 AgriTUFF - 12" vertical brushed

Product code: 9997  
192 sq ft/CTN  
16 panels/CTN  
Length: 12'

#### Skirting Top Rail Mount

Product code: 0084  
576 ft/CTN  
48 pcs/CTN  
Length: 12'

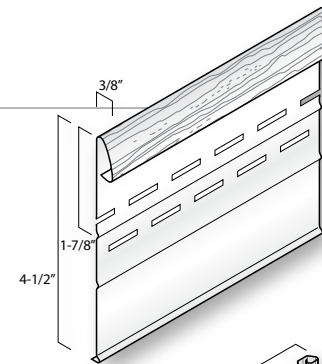

#### Skirting Top Rail Front

Product code: 0083  
576 ft/CTN  
48 pcs/CTN  
Length: 12'

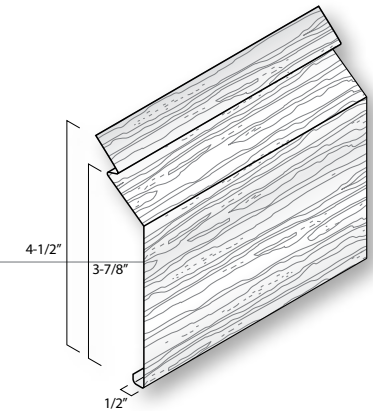

#### W.B.P. Solid Skirting Panel

Product code: 0080  
192 sq ft/CTN  
12 panels/CTN  
Length: 12'

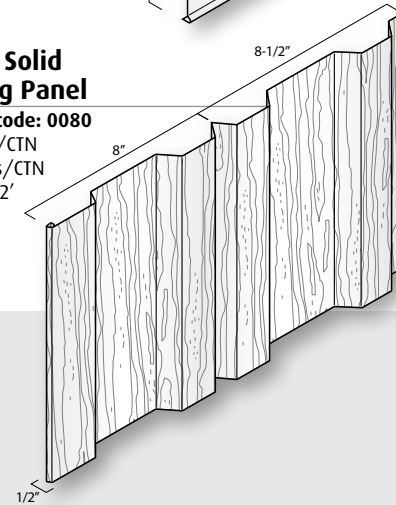

#### W.B.P. Vented Skirting Panel

Product code: 0081  
192 sq ft/CTN  
12 panels/CTN  
Length: 12'

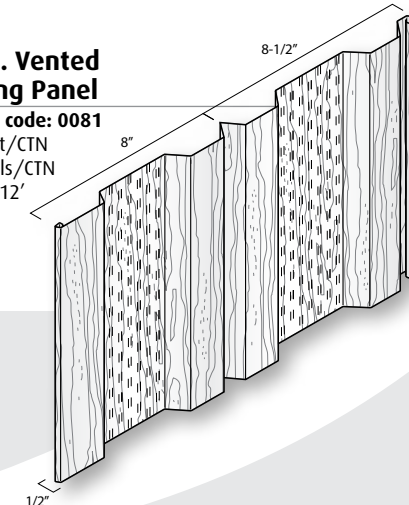

#### Skirting Bottom Rail

Product code: 0082  
432 ft/CTN  
36 pcs/CTN  
Length: 12'

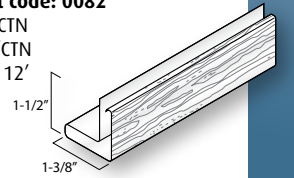

Consult your local Kaycan distribution centre for product availability



# ALUMINUM SIDING

## Aluminum Siding

Long lasting style. Kaycan's Aluminum siding has long been the established standard in the industry for performance and beauty.

- Two-coat system includes a roller-coated primer and baked-on corrosion inhibitor for long-lasting beauty and performance.
- Guaranteed not to crack or flake.
- Available in smooth and woodgrain in a variety of profiles and colors.



Kaycan's Aluminum Siding, Soffit and Trim have long been the established standard within the industry, with a proven track record of over four decades for sturdiness, performance and beauty.

Kaycan's Aluminum products are coated using a proprietary two-coat system and an advanced baked-on thermo-setting Polycoat 9000™ topcoat, giving an extremely durable and fade-resistant paint finish with the highest abrasion-resistant factor on the market.

## ALUMINUM SIDING, SOFFITS AND TRIMS

Kaycan's Aluminum siding is available in both smooth and textured finishes, with a complete color-coordinated trim and accessories line. Kaycan also offers the widest range of Trim Coil colors manufactured with the same proprietary technology for the best quality and selection.

**Horizontal D4.75 Smooth**  
**Product code: 0041**  
 187 sq ft/CTN  
 24 panels/CTN  
 Length: 12'-6"

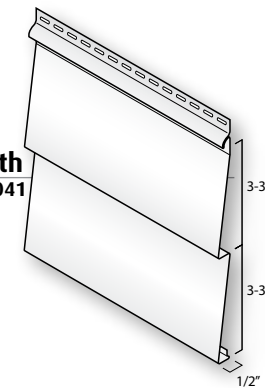

**Horizontal D4.75 Driftwood**  
**Product code: 0043**  
 187 sq ft/CTN  
 24 panels/CTN  
 Length: 12'-6"

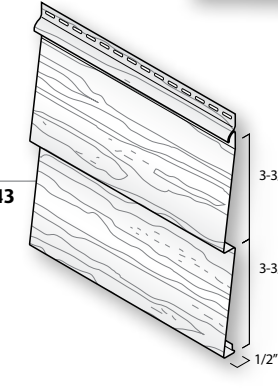

**D4.75D Futura**  
**Product code: 0032**  
 203 sq ft/CTN  
 26 panels/CTN  
 Length: 12'-6"

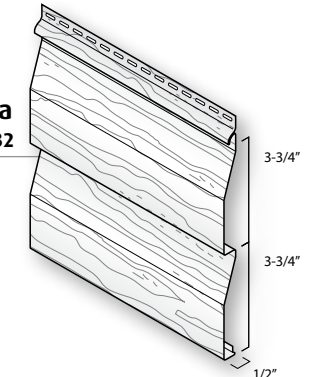

**Vertical 8" Smooth**  
**Product code: 0200**  
 97 sq ft/CTN  
 15 panels/CTN  
 Length: 9'-8"

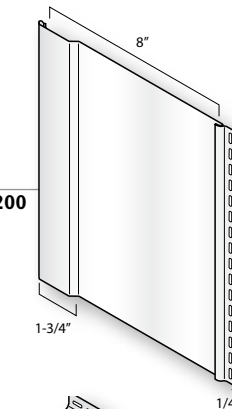

**Vertical 8" Driftwood**  
**Product code: 0211**  
 97 sq ft/CTN  
 15 panels/CTN  
 Length: 9'-8"

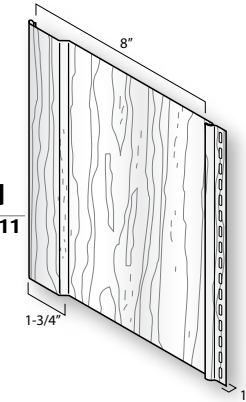

**Vertical 7.5" V-Groove Smooth**  
**Product code: 0222**  
 97 sq ft/CTN  
 13 panels/CTN  
 Length: 12'

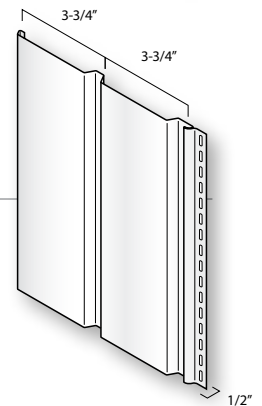

**Horizontal 8" Smooth**  
**Product code: 0010**  
 194 sq ft/CTN  
 24 panels/CTN  
 Length: 12'-1"

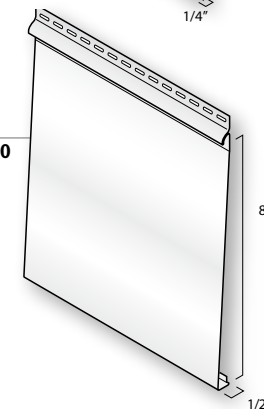

**Horizontal 8" Driftwood**  
**Product code: 0022**  
 194 sq ft/CTN  
 24 panels/CTN  
 Length: 12'-1"

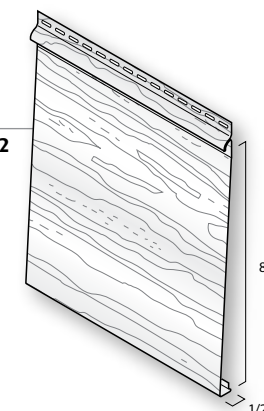

Consult your local Kaycan distribution centre for product availability





**KAYCAN**  
ALUMINUM  
**urbanix™**  
collection

The sleek look is perfectly suited for modern contemporary designs. Urbanix' clean lines will push style to the edge. Incorporate it with other materials and finishes to create contrast and add curb appeal.

Stunning colors, from solid low gloss bold colors to two tone authentic wood tones

Contemporary look is exhibited through the unique design

Premium 0.027" thickness

Manufactured with high tensile strength aluminum. Will not rust or rot



Solid Colors			Two Tones	

\* Premium Color



**Starter Strip**

**Product code: 9926**  
264 ft/CTN  
22 pcs/CTN  
Length: 12 ft

Please order in matching color as bottom portion will be visible.

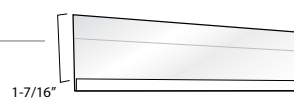

**Corner**

**Product code: 9924**  
100 ft/CTN  
10 pcs/CTN  
Length: 10 ft

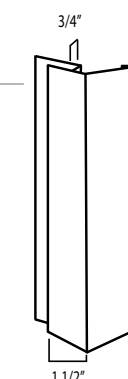

**Urbanix**

**Product code: 9920**  
96 sq ft/CTN  
16 pcs/CTN  
Length: 12'

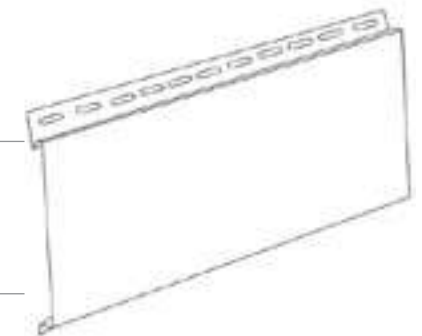

**Urbanix (Special Length)\***

**Product code: 9922**

\* Minimum order quantity required

**Urbanix Soffit**

**Product code: 9921**  
96 sq ft/CTN  
16 pcs/CTN  
Length: 12'

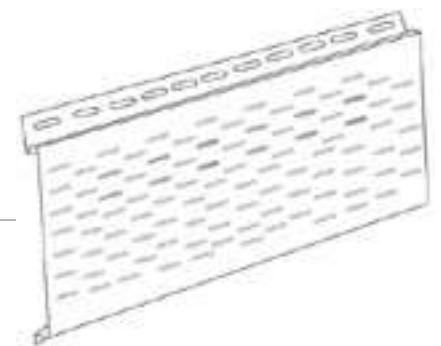

**3/8" J Trim**

**Product code: 1029**  
600 ft/CTN  
50 pcs/CTN  
Length: 12'

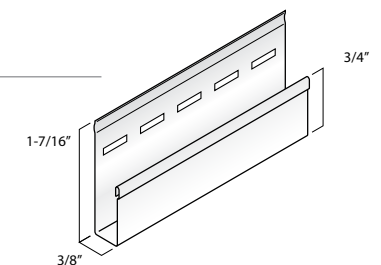

**H Trim\***

**H Trim\***

**Product code: 9925**  
100 ft/CTN  
10 pcs/CTN  
Length: 10'

\* Available Special Order Only

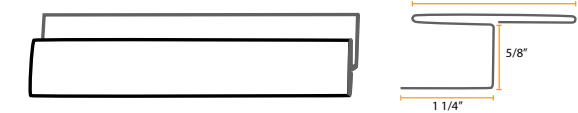

**Flat Stock (23.75" x .027" x 30M)**

**Product code: 0747**  
100 ft/Roll

\* Not available in all colors. Please contact your local sales representative for complete color offerings.







Striking a balance between modern and refined design, ALTIX aluminum siding will transform any project.

The Altix Collection featuring **hidden fasteners**, provides clean uninterrupted lines perfectly suited for modern contemporary designs as well as light commercial projects and store fronts.



Altix Nuvo Vertical 6"



12 rich low gloss colors



Highly recyclable material



High quality exterior cladding



Fire resistant

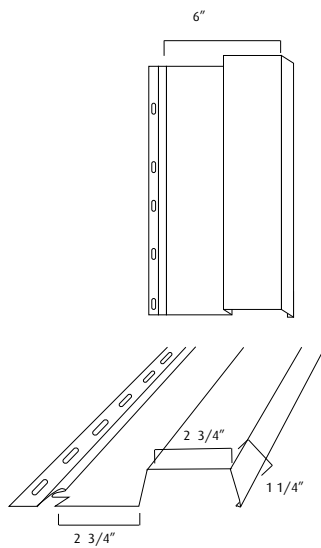

Available in 12 low gloss colors

Wolf White	Silver Bullet
Pearl Gray	Charcoal
Ivory LG	Bronze
Prestige Beige	Granite Rustic
Grafton Gray	Commercial Brown
Sandalwood	Black LG

**Altix Nuvo Vertical Siding 6"**  
Product code: 9934

**Altix 6" Heavy Gauge**  
Product code: 9935

Custom made lengths from 8ft to 18 ft.

www.kaycan.com  
Consult your local Kaycan distribution centre for product availability

# ALUMINUM SOFFIT

Creates a beautifully enduring home finish.

- Never needs painting.
- Available in regular and heavy gauge for lasting performance and durability.
- Available in an array of styles and colors coordinated to match or complement Kaycan vinyl and Aluminum siding.



## Deluxe 16" Vented Soffit HG

Product code: 0610  
192 sq ft/CTN  
12 panels/CTN  
Length: 12'

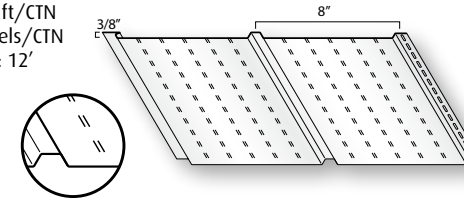

## Quad 4 Solid

Product Code: 0612  
192 ft/CTN  
12 panels/CTN  
Length: 12'

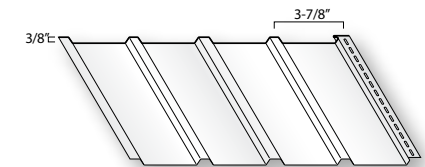

## SP-100 16" Vented Soffit

Product code: 0613  
192 sq ft/CTN  
12 panels/CTN  
Length: 12'

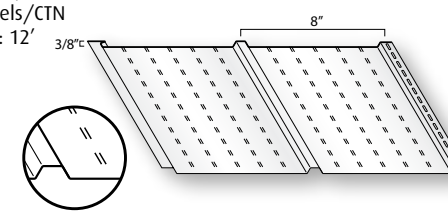

## Quad 4 Full Vent

Product Code: 0609  
192 ft/CTN  
12 panels/CTN  
Length: 12'

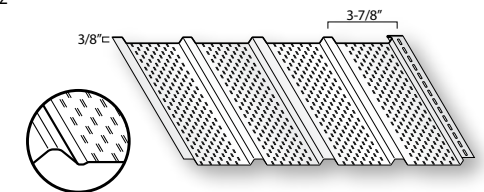

## 16" Solid Soffit HG

Product code: 0600  
192 sq ft/CTN  
12 panels/CTN  
Length: 12'

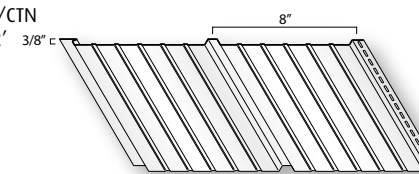

## SP-600 16" Vented Soffit

Product code: 0605  
192 sq ft/CTN  
12 panels/CTN  
Length: 12'

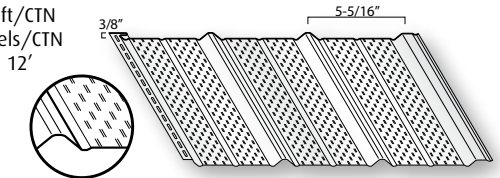

## SP-100 16" Solid Soffit

Product code: 0604  
192 sq ft/CTN  
12 panels/CTN  
Length: 12'

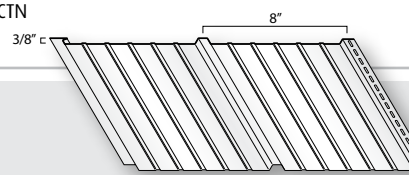

## SP-600 16" Solid Soffit

Product code: 0606  
192 sq ft/CTN  
12 panels/CTN  
Length: 12'

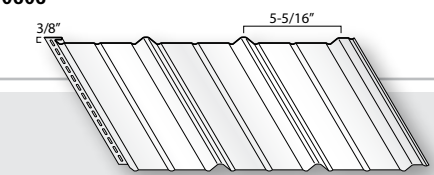

Consult your local Kaycan distribution centre for product availability



## ALUMINUM TRIMS AND ACCESSORIES

### Aluminum Accessories

Limitless design possibilities and quality withstands the test of time. Color matched to Kaycan's Aluminum and vinyl siding and soffit, Kaycan Aluminum accessories are coated with the same thermo-setting polyester Polycoat 9000™ topcoat used on Kaycan Aluminum siding for a durable and fade resistant paint finish with the highest abrasion-resistant factor on the market.

- Complete color coordinated range of accessories.

#### Aluminum Flatstock Trim Coils

Product Code:	Description
0722	24" X 30 m Aluminum Flatstock - Matchcoat
0729	24" X 30 m Aluminum Flatstock - HG
0721	24" X 30 m Aluminum Flatstock
0728	36" X 30 m Aluminum Flatstock
0719	24" X 15 m Aluminum Flatstock
0727	24" X 50' Aluminum Flatstock - Matchcoat
0331	24" X 50' Aluminum Flatstock - Solmica PVC coated



Note - Direct contact of Aluminum products with certain dissimilar materials or contact with the water run off from such materials is likely to result in corrosion. Therefore care should be exercised to avoid contact of Aluminum with any corrosive materials during installation including but not limited to: pretreated lumber, concrete, masonry cement, stucco, salt, corrosive chemicals, dissimilar metals (copper, zinc, steel, etc.)

#### 1/2" J Trim

**Product code P15: 1042**  
600 ft/CTN  
50 pcs/CTN  
Length: 12'

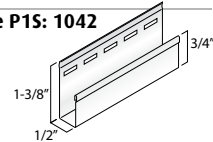

**Product code P25: 1043**  
600 ft/CTN  
50 pcs/CTN  
Length: 12'

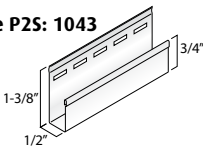

#### 1-1/8" J Trim

**Product code: 1050**  
600 ft/CTN  
50 pcs/CTN  
Length: 12'

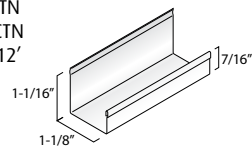

#### L Trim

**Product code: 1010**  
240 ft/CTN  
20 pcs/CTN  
Length: 12'

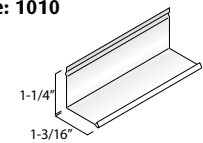

#### Super J Trim

**Product code: 1057**  
240 ft/CTN  
20 pcs/CTN  
Length: 12'

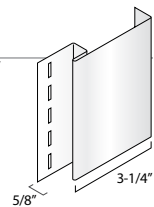

#### Drip Cap

**Product code: 1180**  
300 ft/CTN  
25 pcs/CTN  
Length: 12'

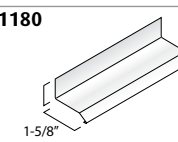

#### Outside Corner

**Product code: 1100**  
98 ft/CTN  
10 pcs/CTN  
Length: 9'-10"

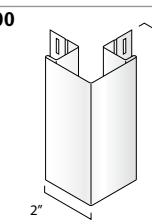

#### 2" Drip Cap

**Product code: 1181**  
360 ft/CTN  
30 pcs/CTN  
Length: 12'

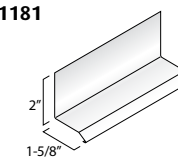

#### Inside Corner

**Product code: 1110**  
98 ft/CTN  
10 pcs/CTN  
Length: 9'-10"

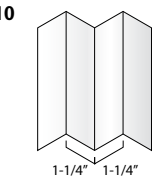

#### 3" Drip Cap

**Product code: 1184**  
360 ft/CTN  
30 pcs/CTN  
Length: 12'

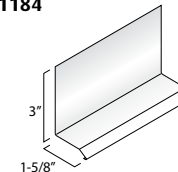

#### Undersill Trim

**Product code: 1060**  
240 ft/CTN  
20 pcs/CTN  
Length: 12'

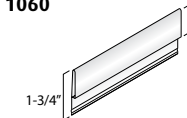

#### Belt Line

**Product code: 1170**  
300 ft/CTN  
25 pcs/CTN  
Length: 12'

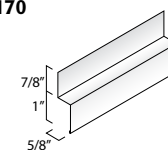

#### Gable Trim

**Product code: 1070**  
600 ft/CTN  
50 pcs/CTN  
Length: 12'

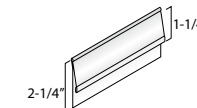

#### Starter Strip

**Product code: 108100**  
480 ft/CTN  
40 pcs/CTN  
Length: 12'

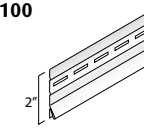

Used with Aluminum siding.

#### Kaylok Aluminum Starter Trim

**Product code: 108200**  
500 ft/CTN  
50 pcs/CTN  
Length: 10'

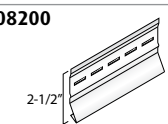

#### Reversible Drip Cap

**Product code: 1161**  
360 pi/CTN  
30 pcs/CTN  
Length: 12'

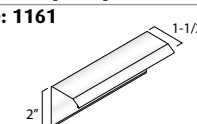

#### Large Gable Trim

**Product code: 1270XX**  
480 ft/CTN  
40 pcs/CTN  
Length:

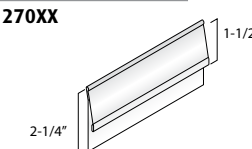

#### Trimboard Drip Cap

**Product code: 1286XX**  
360 ft/CTN  
20 pcs/CTN  
Length: 12'

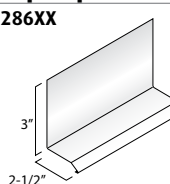

Consult your local Kaycan distribution centre for product availability



## ALUMINUM ACCESSORIES

### 2" Aluminum Drip Edge

Product code: 2091  
492 ft/CTN  
50 pcs/CTN  
Length: 9'-10"

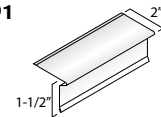

### 2" Eco Drip Edge

Product code: 2089  
492 ft/CTN  
50 pcs/CTN  
Length: 9'-10"

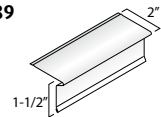

### 2 1/2" Aluminum Drip Edge

Product code: 2099  
196 ft/CTN  
20 pcs/CTN  
Length: 9'-10"

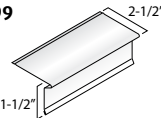

### 4" Aluminum Drip Edge

Product code: 2092  
491 ft/CTN  
50 pcs/CTN  
Length: 9'-10"

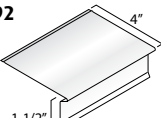

Product code: 2100  
492 ft/CTN  
50 pcs/CTN  
Length: 9'-10"

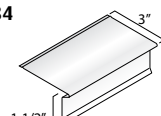

### 3" Aluminum Drip Edge

Product code: 2084  
393 ft/CTN  
40 pcs/CTN  
Length: 9'-10"

### Special Eaves Starter

Product code: 1086  
295 ft/CTN  
30 pcs/CTN  
Length: 9'-10"

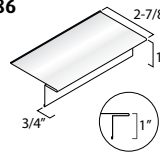

### Regular Eaves Starter

Product code: 1084  
236 ft/CTN  
24 pcs/CTN  
Length: 9'-10"

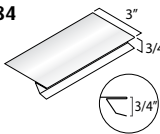

### Aluminum Roof Edge

Product code: 2101  
250 ft/CTN  
25 pcs/CTN  
Length: 9'-10"

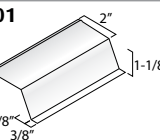

### 2" X 2" Reversible Drip Edge

Product code: 2086  
492 ft/CTN  
50 pcs/CTN  
Length: 9'-10"

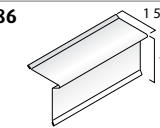

### 3" X 3" Reversible Drip Edge

Product code: 2085  
394 ft/CTN  
40 pcs/CTN  
Length: 9'-10"

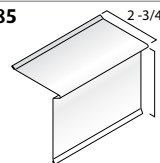

### 4" Fascia

Product code: 0495  
393 ft/CTN  
40 pcs/CTN  
Length: 9'-10"

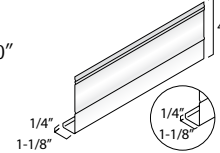

### 6" Fascia

Product code: 0480  
196 ft/CTN  
20 pcs/CTN  
Length: 9'-10"

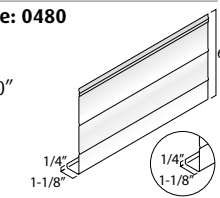

### 8" Fascia

Product code: 0481  
196 ft/CTN  
20 pcs/CTN  
Length: 9'-10"

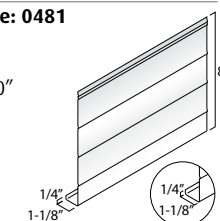

### 10" Fascia

Product code: 0535  
98 ft/CTN  
10 pcs/CTN  
Length: 9'-10"

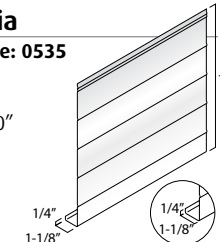

### 3/8" Soffit J Trim

Product code: 1029  
600 ft/CTN  
50 pcs/CTN  
Length: 12'

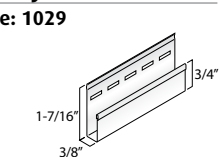

### 3/8" Soffit F Trim

Product code: 1191  
Product code HG: 1192  
600 ft/CTN  
50 pcs/CTN  
Length: 12'

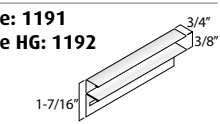

### 3/8" Soffit J Trim Eco

Product code: 1028  
900 ft/CTN  
75 pcs/CTN  
Length: 12'

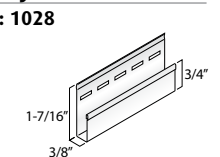

### 1/2" J Trim

Product code P15: 1042  
600 ft/CTN  
50 pcs/CTN  
Length: 12'

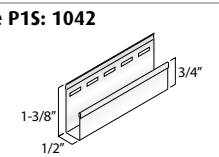

### Product code P25: 1043

600 ft/CTN  
50 pcs/CTN  
Length: 12'

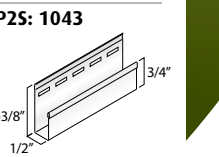

### 9/16" Soffit F Trim

Product code: 1194  
480 ft/CTN  
40 pcs/CTN  
Length: 12'

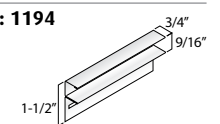

Consult your local Kaycan distribution centre for product availability





## CENTURY SERIES ALUMINUM

## CENTURY SERIES GALVANIZED

### Century Series

Natural Aluminum, pre painted Aluminum, and galvanized steel accessories are available in an array of shapes and sizes to cover and protect any challenging application.

#### 2" x 2" Aluminum Angle Flashing

Product code: 1072  
100 ft/CTN  
10 pcs/CTN  
Length: 10'

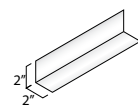

#### 7/8" Aluminum Drip Cap

Product code: 1151  
250 ft/CTN  
25 pcs/CTN  
Length: 10'

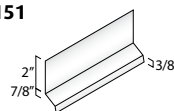

#### 3" x 4" X 10-1/2" Aluminum Step Flashing

Product code: 1079  
100 pcs/PKG  
Length: 10 1/2"

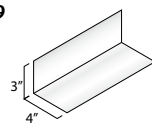

#### 2" x 2" Galvanized Angle Flashing

Product code: 108000  
100 ft/CTN  
10 pcs/CTN  
Length: 10'

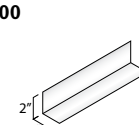

#### 7/8" Galvanized Drip Cap

Product code: 115500  
100 ft/CTN  
10 pcs/CTN  
Length: 10'

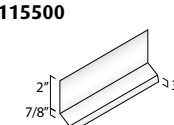

#### 1-1/4" Steel Window and Door Flashing

Product code: 116501  
100 ft/CTN  
10 pcs/CTN  
Length: 10'

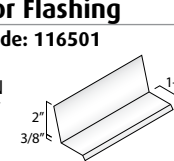

#### 3" x 3" Aluminum Angle Flashing

Product code: 1073  
100 ft/CTN  
10 pcs/CTN  
Length: 10'

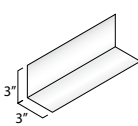

#### 1-3/8" Aluminum Drip Cap

Product code: 1152  
250 ft/CTN  
25 pcs/CTN  
Length: 9'10"

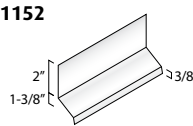

#### 2-1/2" x 3-1/2" x 8-1/2" Aluminum Step Flashing

Product code: 107150  
100 pcs/PKG  
Length: 8-1/2"

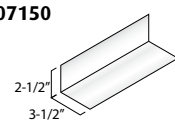

#### 3" x 3" Galvanized Angle Flashing

Product code: 108050  
100 ft/CTN  
10 pcs/CTN  
Length: 10'

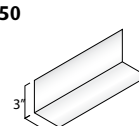

#### 1-3/8" Galvanized Drip Cap

Product code: 115600  
100 ft/CTN  
10 pcs/CTN  
Length: 10'

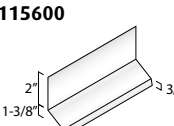

#### 1-3/4" Steel Window and Door Flashing

Product code: 116601  
100 ft/CTN  
10 pcs/CTN  
Length: 10'

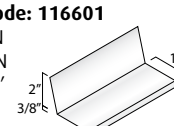

#### 4" x 4" Aluminum Angle Flashing

Product code: 1074  
100 ft/CTN  
10 pcs/CTN  
Length: 10'

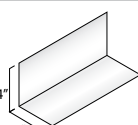

#### 1-3/4" Aluminum Drip Cap

Product code: 1153  
250 ft/CTN  
25 pcs/CTN  
Length: 9'10"

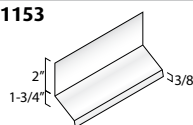

#### 3-1/2" x 3-1/2" x 8-1/2" Aluminum Step Flashing

Product code: 1078  
100 pcs/PKG  
Length: 8-1/2"

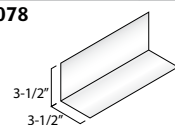

#### 4" x 4" Galvanized Angle Flashing

Product code: 108060  
100 ft/CTN  
10 pcs/CTN  
Length: 10'

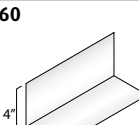

#### 1-3/4" Galvanized Drip Cap

Product code: 115700  
100 ft/CTN  
10 pcs/CTN  
Length: 10'

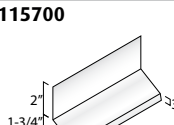

#### 2-1/2" Steel Window and Door Flashing

Product code: 116701  
100 ft/CTN  
10 pcs/CTN  
Length: 10'

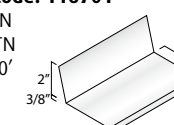

#### Aluminum Mill Finish Rolls

Product code:	Dimensions
038500	6" x 10'
038600	9" x 10'
038700	12" x 10'
038800	18" x 10'
038900	24" x 10'
039000	36" x 10'
073090	6" x 50'
073100	9" x 50'
073150	12" x 50'
073155	18" x 50'
073157	24" x 50'
073158	36" x 50'
073159	6" x 150'
073160	9" x 150'
073165	12" x 150'
073170	18" x 150'
073171	24" x 150'
073172	36" x 150'

#### Handy Rolls Mill Finish

Product code:	Dimensions
038000	14" x 10'
038050	20" x 10'

#### Aluminum Painted Rolls (Chocolate/White)

Product code:	Dimensions
0385	6" x 10'
0386	9" x 10'
0387	12" x 10'
0388	18" x 10'
0389	24" x 10'
0390	36" x 10'
0732	6" x 50'
0733	9" x 50'
0734	12" x 50'
0735	18" x 50'
0738	24" x 50'
0731	36" x 50'

#### Handy Rolls Painted (White)

Product code:	Dimensions
038001	14" x 10'
038101	20" x 10'

#### 3" x 4" X 10-1/2" Galvanized Step Flashing

Product code: 107900  
100 pcs/PKG  
Length: 10-1/2"

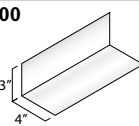

#### Galvanized Eaves Starter

Product code: 108400  
236 ft/CTN  
24 pcs/CTN  
Length: 9'-10"

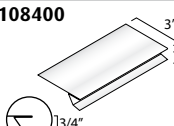

#### Galvanized Roll Flashing

Product code:	Dimensions
0391	6" x 10'
0392	9" x 10'
0393	12" x 10'
0394	18" x 10'
0395	24" x 10'
0396	36" x 10'
070360	6" x 50'
070400	9" x 50'
070450	12" x 50'
070455	18" x 50'
070460	24" x 50'
070470	36" x 50'

#### 2-1/2" X 2-1/2" Steel Drip Edge

Product code: 9730  
200 ft/CTN  
20 pcs/CTN  
Length: 10'

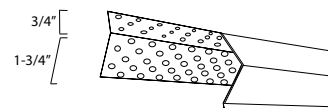
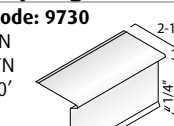

#### Anti-Rodent Trim

Product code: 711100  
295 ft/CTN  
30 pcs/CTN  
Length: 10'  
Can be used separately





Nature at its best.... KWP Engineered Wood products are the natural choice for any home. Our commitment in offering the highest quality exterior finish products having detailed craftsmanship combined with durability, ease of maintenance and a vast array of color choices is exemplified with KWP.

## KWP PREFINISHED ENGINEERED WOOD PRODUCTS

Prefinished Engineered Wood products offer all the advantages of regular wood siding without the drawbacks of rotting, cracking, splitting and termite damage. KWP products are Eco-consciously manufactured with quality additives following a unique and stringent process that increases strength, rigidity, and durability while lessening our carbon footprint through effective raw material usage and energy reduction processes.



## HAMPTON SHAKE

## TRIM BOARD

### Hampton Shake

KWP Hampton Shake Panels have the appearance and charm of classic shakes along with intricate shadow lines that enhance the appearance of any home. A vintage blend of beauty and craftsmanship combined with modern technology.

- Heavy duty 1/2" thickness 30% thicker than competitive products.
- Superior design allows for all nails to be hidden.
- Designed Interlock System for precise alignment resulting in ease of installation.
- Baked on factory finish for ultra-low maintenance.
- Available in a full palette of designer colors.



Hampton Shake

### Hampton Shake

**Product code: WSHS48XX**  
24.4 sq ft/CTN  
10 panels/CTN  
Length: 48-5/8"

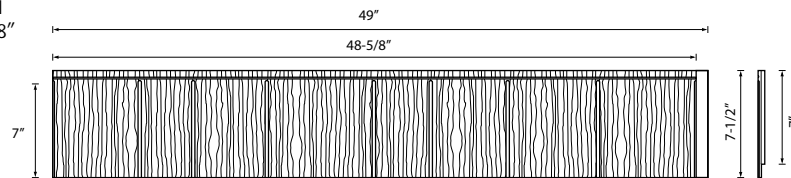

### Trim Board

KWP's Trim Board enhances the beauty of any home design. With 4 coats of acrylic paint baked on at high temperatures our trim not only will resist the harshest climates but is the perfect accent to complete any home design.

- Available in 3/4 and 5/4 widths.
- Factory painted eliminates on site painting.
- Won't crack, split, or rot.
- Prefinished on three side and ready to install.
- Uniform thickness ensures ease of installation.

### TRIM BOARD - 12' LENGTHS

Codes	Board Thickness	Board Width	Units (per package)	Weight (lbs per unit)	Units (per bundles)	Weight (lbs per bundle)
WTB5441200	5/4	4"	2	14.98	240	3595
WTB5451200	5/4	5"	2	19.26	192	3698
WTB5461200	5/4	6"	2	23.54	144	3390
WTB5481200	5/4	8"	2	32.1	120	3852
WTB54101200	5/4	10"	2	39.59	96	3801
WTB54121200	5/4	12"	2	48.15	72	3467







Kaycan's Performance Aluminum Rainware Collection is designed for durability and ease of installation, and is coated with the same thermo-setting polyester Polycoat 9000™ topcoat as Kaycan's Aluminum siding. Performance Aluminum rainware is an easy-to-install, corrosion-resistant, durable and fade resistant system available in rich decorative colors and color-coordinated accessories.

## RAIN CARRYING SYSTEMS

Kaycan's Plastmo Vinyl Rainware Collection is available in three different profiles: K-Snap, U-Snap and Classic Half-Round for a modern touch. The Plastmo vinyl rainware line is durable, scratch-resistant and easy-to-install.



## PERFORMANCE ALUMINUM RAINWARE

### Performance Aluminum Rainware System

Designed for durability and ease of installation, Kaycan's Performance Aluminum rain carrying system provides a complementary finish and the proper protection to any home's exterior. Coated with Kaycan' Polycoat 9000™ topcoat, Performance Aluminum rainware is corrosion-resistant and maintains a freshly painted look year-after-year.

Drop Outlet

Inside Corner

Right End Cap

Connector

Performance K-Style Gutter

Left End Cap

2" x 3" A-Elbows

Outside Corner

Pipe Strap

2" x 3" B-Elbows

2" x 3" Downspout

2" x 3" A-Elbows

See following pages for Downspout element description and ordering codes.

<p><b>5" Gutter</b> Product code: 2302 100 ft/CTN 10 pcs/CTN Length: 10'</p>	<p>Product code: 2312 200 ft/CTN 10 pcs/CTN Length: 20'</p>
<p><b>5" Joint Connector</b> Product code: 2383 10 pcs/CTN</p>	<p><b>5" Drop Outlet</b> Product code: 2387 5 pcs/CTN</p>
<p><b>5" Outside Corner</b> Product code: 2360 20 pcs/CTN</p>	<p><b>5" Quick Screw Hanger</b> Product code: 242100 300 pcs/CTN</p>
<p><b>5" Inside Corner</b> Product code: 2380 20 pcs/CTN</p>	<p><b>5" Jumbo Hanger</b> Product code: 243800 400 pcs/CTN</p>
<p><b>5" Gutter Wedge</b> Product code: 2395 350 pcs/CTN</p>	<p><b>5" Stamped Hanger</b> Product code: 243000 500 pcs/CTN</p> <p>Product code: 243600A 10 pcs/BAG</p>
<p><b>5" Left End Cap</b> Product code: 2400 50 pcs/CTN</p>	<p><b>5" Extruded Hanger</b> Product code: 2432 500 pcs/CTN</p> <p>Product code: 243500 10 pcs/BAG</p>
<p><b>5" Right End Cap</b> Product code: 2401 50 pcs/CTN</p>	<p><b>5" Clip-On Hanger</b> Product code: 242900 500 pcs/CTN</p>
<p><b>Gutter Hanger Roof Strap</b> Product code: 243700 100 pcs/CTN</p> <p>Hanger not included</p>	

### 5" Aluminum ProGuard II

Product code: 226000  
400 ft/CTN, 40 pcs/CTN  
Length: 10'

### Performance 5" ProGuard II 4'

Product code: 226300  
100 ft/CTN, 25 pcs/CTN  
Length: 4'

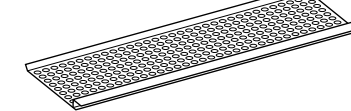

### 5" Inside Strip Mitre

Product code: 2381  
20 pcs/CTN

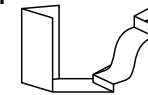

### 5" Outside Strip Mitre

Product code: 2382  
20 pcs/CTN

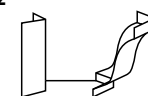

### 5" Inside Bay Mitres

Product code: 2379  
20 pcs/CTN

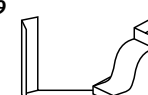

### 5" Outside Bay Mitres

Product code: 2378  
20 pcs/CTN

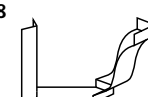

### 5" Gutter Sentry

Product code: GS2025  
30pcs/CTN  
Length: 7'



### 6" Gutter Sentry

Product code: GS5026  
25pcs/CTN  
Length: 7'



### 6" Aluminum ProGuard II

Product code: 226200  
300 ft/CTN, 30 pcs/CTN, Length: 10'

Performance 6" ProGuard II 4'  
Product code: 226400  
100 ft/CTN, 25 pcs/CTN,  
Length: 4'

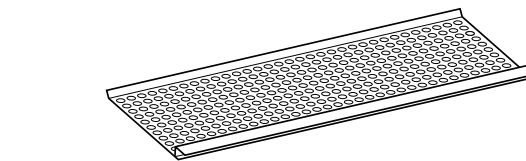

### 6" Inside Strip Mitre

Product code: 2385  
20 pcs/CTN



### 6" Outside Strip Mitre

Product code: 2386  
20 pcs/CTN

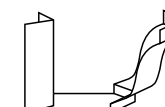

### 6" Left End Cap

Product code: 2402  
50 pcs/CTN

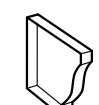

### 6" Gutter Wedge

Product code: 2396  
200 pcs/CTN

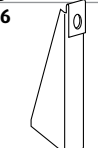

### 6" Right End Cap

Product code: 2403  
50 pcs/CTN

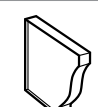

### 6" Quick Screw Hanger

Product code: 242200  
200 pcs/CTN

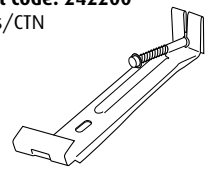

### 6" Premium Clip-On Hanger

Product code: 242700  
450 pcs/CTN

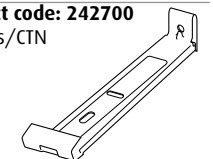

### 6" Jumbo Hanger



Product code: 244500  
400 pcs/CTN



Consult your local Kaycan distribution centre for product availability

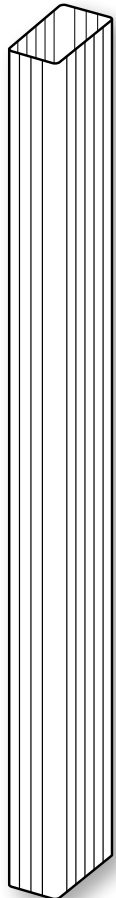
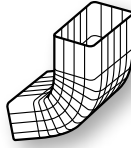
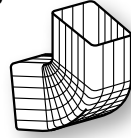
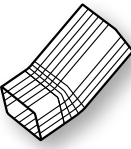
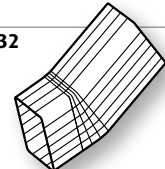
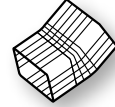

## PERFORMANCE ALUMINUM RAINWARE

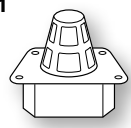
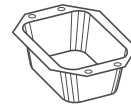
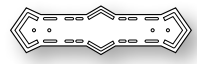
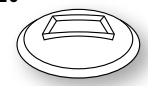
<p><b>2" X 3" Downspout</b> Product code: 2120 98 ft/CTN 10 pcs/CTN Length: 9'-10"</p> 	<p><b>2" X 3" A-Elbow</b> Product code: 2510 30 pcs/CTN</p> 	<p><b>2" X 3" B-Elbow</b> Product code: 2530 30 pcs/CTN</p> 
	<p><b>2" X 3" A-Elbow Offset</b> Product code: 2516 30 pcs/CTN</p> 	<p><b>2" X 3" B-Elbow 30 degrees</b> Product code: 2532 50 pcs/CTN</p> 
	<p><b>2" X 3" A-Elbow 30 degrees</b> Product code: 2515 50 pcs/CTN</p> 	<p><b>2-3/8" Pop-In Outlet</b> Product code: 257300 30 pcs/CTN</p> 
	<p><b>2" X 3" Poly Outlets</b> Product code: 257001 100 pcs/CTN</p> 	<p><b>2" x 3" B-Drop</b> Product code: 257000 30 pcs/CTN</p> 
	<p><b>Pipe Strap</b> Product code: 2540 100 pcs/CTN</p> 	<p><b>2" X 3" Tile Cover</b> Product code: 8420</p> 

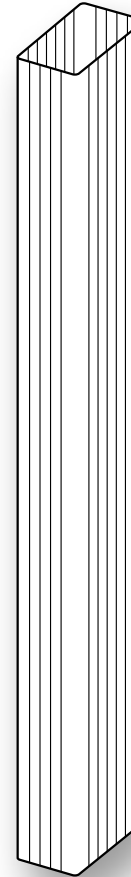
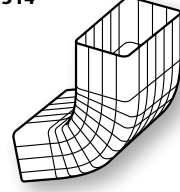
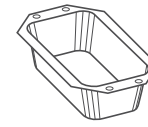
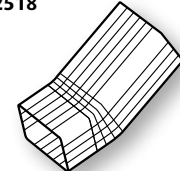
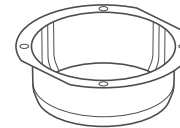
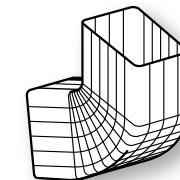
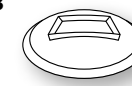
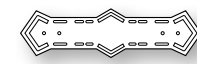
<p><b>3" X 4" Downspout</b> Product code: 2124 118 ft/CTN 12 pcs/CTN Length: 9'-10"</p> 	<p><b>3" X 4" A-Elbow</b> Product code: 2514 30 pcs/CTN</p> 	<p><b>3" x 4" B-Drop</b> Product code: 258000 50 pcs/CTN</p> 
	<p><b>3" X 4" A-Elbow Offset</b> Product code: 2518 36 pcs/CTN</p> 	<p><b>2 3/4" Pop-In Outlet</b> Product code: 257400 50 pcs/CTN</p> 
	<p><b>3" X 4" B-Elbow</b> Product code: 2531 30 pcs/CTN</p> 	<p><b>3" X 4" Tile Cover</b> Product code: 8423 200 pcs/CTN</p> 
		<p><b>Pipe Strap</b> Product code: 2540 100 pcs/CTN</p> 

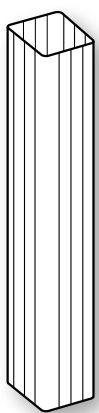
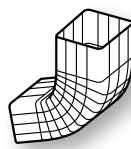
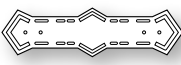
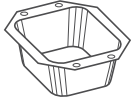
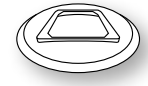
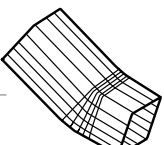
<p><b>2 1/2" Square Downspout</b> Product code: 2123 147.5 ft/CTN 15 pcs/CTN Length: 9'-10"</p> 	<p><b>2 1/2" Square Elbow</b> Product code: 2513 50 pcs/CTN</p> 	<p><b>Pipe Strap</b> Product code: 2540 100 pcs/CTN</p> 
	<p><b>2 1/2" x 2 1/2" B-Drop</b> Product code: 258100 30 pcs/CTN</p> 	<p><b>2-1/2" X 2-1/2" Tile Cover</b> Product code: 8421</p> 
	<p><b>2 1/2" x 2 1/2" 30°</b> Product code: 2517 50 pcs/CTN</p> 	

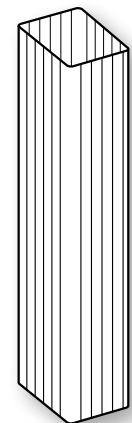
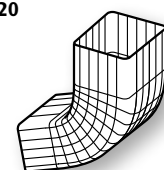
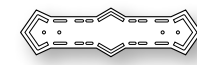
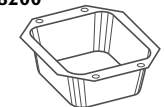
<p><b>3" Square Downspout</b> Product code: 2128 117 ft/CTN 12 pcs/CTN Length: 9'-10"</p> 	<p><b>3" Square Elbow</b> Product code: 2520 40 pcs/CTN</p> 	<p><b>Pipe Strap</b> Product code: 2540 100 pcs/CTN</p> 
	<p><b>3" x 3" B-Drop</b> Product code: 258200 30 pcs/CTN</p> 	

Consult your local Kaycan distribution centre for product availability



## PERFORMANCE ALUMINUM RAINWARE

### Aluminum Gutter Coil

**Product code: 0745XX**  
 .023" Gauge  
 11.875" width  
 30m per roll

- Linen White
- Commercial Brown
- Forest Green
- Black LG
- White SG / Ivory SG
- Chocolate SG / White SG
- Sandalwood / Pearl Grey
- Rustic Granite
- Mocha
- Matchcoat Beige
- Sable (Cactus)
- Prestige Beige / Charcoal
- Matchcoat Sandalwood
- Khaki

### Aluminum Gutter Coil

**Product code: 0770**  
 .023" Gauge  
 11.875" width  
 200 lbs per roll

- White SG
- Chocolate SG
- Ivory SG
- Commercial Brown
- Black SG
- Forest Green
- Sandalwood / Pearl Grey
- Prestige Beige / Charcoal
- Georgian Grey
- Linen White
- Maritime White
- MC Beige
- MC Sandalwood
- Wicker
- Mocha
- Wolf White
- Chocolate SG / White SG
- Sable (Cactus)
- Khaki
- Rustic Granite
- Black LG

**Product code: 0775**  
 .027" Gauge  
 11.875" width  
 200 lbs per roll

- White Semi-Gloss
- Pearl Grey / Wolf White
- Sandalwood / Wolf White
- Ivory Low-Gloss / Wolf White
- Linen White / Wolf White
- Forest Green / Wolf White
- Prestige Beige / Wolf White
- Chocolate Low-Gloss / Wolf White
- Charcoal / Wolf White
- Polar White
- Matchcoat Sandalwood / Wolf White
- Matchcoat Beige / Wolf White
- US Bronze / Wolf White
- Commercial Brown / Wolf White
- Black LG / Wolf White
- Rustic Granite / Wolf White
- Wolf White

**Product code: 0777**  
 .027" Gauge  
 15" width  
 200 lbs per roll

- Wolf White
- Chocolate Low-Gloss / Wolf White
- Ivory Low-Gloss / Wolf White
- Linen White / Wolf White
- Prestige Beige / Wolf White
- Pearl Grey / Wolf White
- Polar White
- US Bronze / Wolf White
- Matchcoat Sandalwood / Wolf White
- Matchcoat Beige / Wolf White
- Charcoal / Wolf White
- Sandalwood / Wolf White
- Wicker / Wolf White
- Commercial Brown / Wolf White
- Black LG / Wolf White

**Product code: 0772**  
 .023" Gauge  
 13.5" width  
 200 lbs per roll

- Linen / White SG
- Sandalwood / White SG
- Prestige Beige / Charcoal
- Chocolate SG / White SG
- Wicker / White SG
- MC Sandalwood / White SG
- MC Beige / White SG
- Commercial Brown / White SG
- Sable (Cactus) / White SG
- Black LG / Wolf White
- Ivory SG / Wolf White
- US Bronze / MC Sandalwood
- Wolf White / Pearl Grey
- Rustic Granite / Wolf White



### Pan Robertson Screws

**#6 3/8" Product code: 1400**  
 1000 screws/box  
**#6 5/8" Product code: 1402**  
 1000 screws/box  
**#8 1-1/2" Product code: 1410**  
 250 screws/box  
**#8 2-1/2" Product code: 1411**  
 100 screws/box

**Pop Rivets**  
**Product code: 2560**

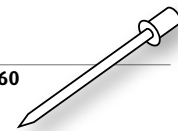

**#8 3" Product code: 1412**  
 100 screws/box

**#8 5/8" Product code: 1404**  
 1000 screws/box

**#8 x 1 1/4" Product code: 1435**  
 100 screws/box

**#6 x 5/8" Product code: 1442**  
 100 screws/box

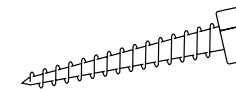

### Silicone (White or Clear)

**Product code: 2059**  
 12 tubes/CTN



### Support Pipe

**Product code: 2444**  
 100 pcs/CTN

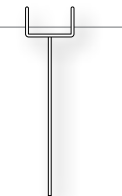

Consult your local Kaycan distribution centre for product availability



## K-SNAP VINYL RAINWARE

### K-Snap Vinyl Rainware

Plastmo's K-Snap vinyl rainware exceeds the most stringent industry and government standards at all stages of manufacturing. Durable, scratch-resistant, easy-to-install, and very low-maintenance, the Plastmo line is complemented by a fully coordinated accessories line.

- Snap Together
- Durable
- Easy to Install

#### Available Colors:



\*Special Order

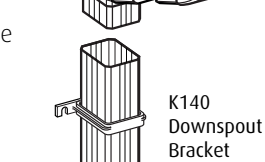
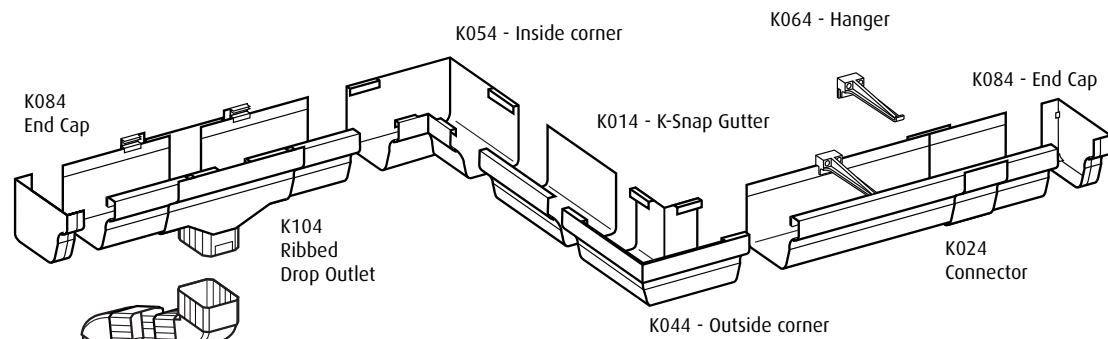

**K-Snap Screws**  
Product code: K310  
20 screws/BAG  
10 bags/CTN



**Cement**  
Product code: P240  
5 fl. Oz/Tube  
10 tubes/CTN

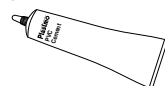

**K-Snap Gutter**  
Product code: K014  
100 ft/CTN  
10 pcs/CTN  
Length: 10'

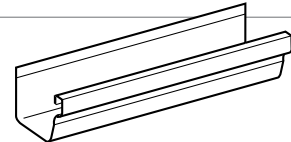

**K-Snap Joint Connector**  
Product code: K024  
40 pcs/CTN

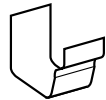

**K-Snap Outside Corner**  
Product code: K044  
10 pcs/CTN

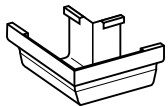

**K-Snap Inside Corner**  
Product code: K054  
10 pcs/CTN

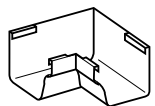

**K-Snap Hanger**  
Product code: K064  
75 pcs/CTN

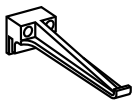

**K-Snap Wedge**  
Product code: K300  
200 pcs/CTN



**K-Snap Drip Edge**  
Product code: K400  
10 pcs/CTN  
Length: 1.6 m

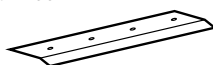

**K-Snap Expansion Connector**  
Product code: K034  
5 pcs/CTN

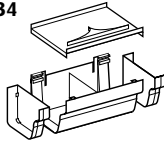

**K-Snap Drop Outlet for Square Downspout**  
Product code: K094  
10 pcs/CTN

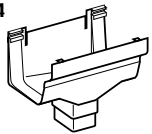

**K-Snap Drop Outlet for Ribbed Downspout**  
Product code: K104  
10 pcs/CTN

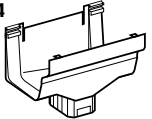

**K-Snap Drop Outlet for Round Downspout**  
Product code: K114  
10 pcs/CTN

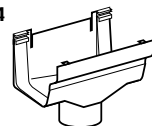

**K-Snap End Cap**  
Product code: K084  
2 per bag/CTN

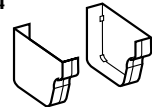

### Ribbed Vinyl Downspout

Available for K-Snap and U-Snap Gutters

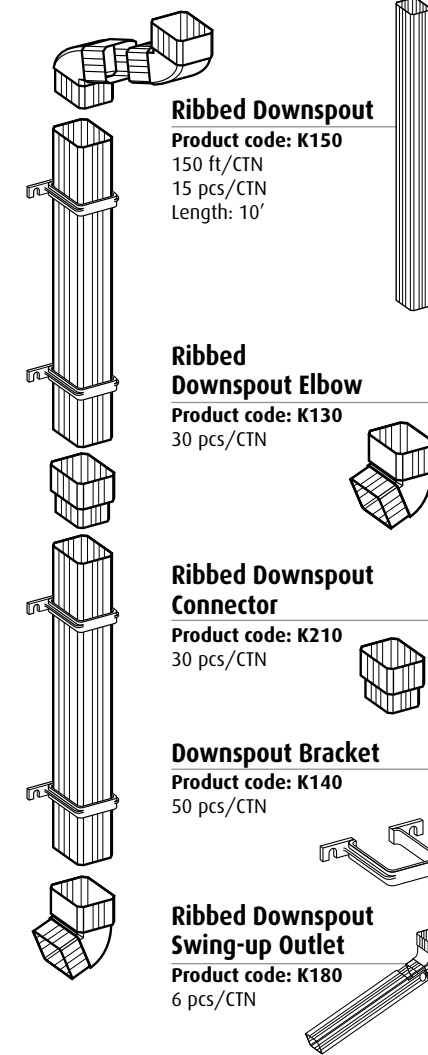

**Ribbed Downspout**  
Product code: K150  
150 ft/CTN  
15 pcs/CTN  
Length: 10'

**Ribbed Downspout Elbow**  
Product code: K130  
30 pcs/CTN

**Ribbed Downspout Connector**  
Product code: K210  
30 pcs/CTN

**Downspout Bracket**  
Product code: K140  
50 pcs/CTN

**Ribbed Downspout Swing-up Outlet**  
Product code: K180  
6 pcs/CTN

#### Available Ribbed Downspout Colors:



\*Special Order

### Square Vinyl Downspout

Available for Classic and K-Snap gutters

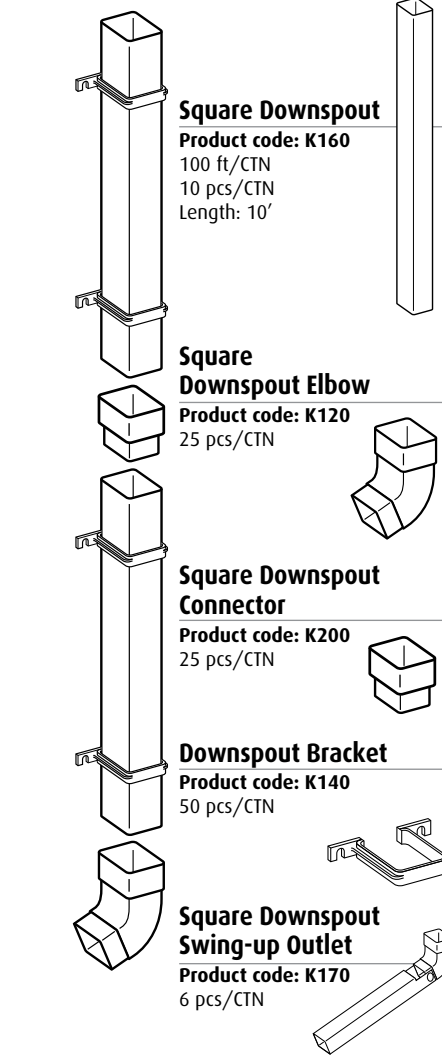

**Square Downspout**  
Product code: K160  
100 ft/CTN  
10 pcs/CTN  
Length: 10'

**Square Downspout Elbow**  
Product code: K120  
25 pcs/CTN

**Square Downspout Connector**  
Product code: K200  
25 pcs/CTN

**Downspout Bracket**  
Product code: K140  
50 pcs/CTN

**Square Downspout Swing-up Outlet**  
Product code: K170  
6 pcs/CTN

#### Available Square and Round Downspout Colors:



Consult your local Kaycan distribution centre for product availability

### Round Vinyl Downspout

available for Classic and K-Snap gutters

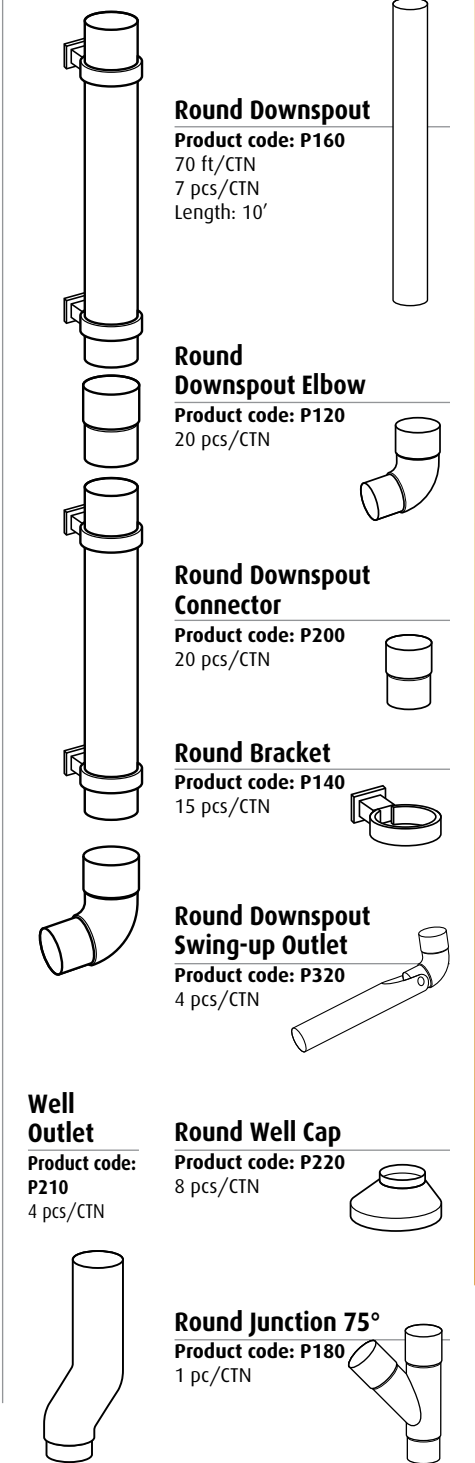

**Round Downspout**  
Product code: P160  
70 ft/CTN  
7 pcs/CTN  
Length: 10'

**Round Downspout Elbow**  
Product code: P120  
20 pcs/CTN

**Round Downspout Connector**  
Product code: P200  
20 pcs/CTN

**Round Bracket**  
Product code: P140  
15 pcs/CTN

**Round Downspout Swing-up Outlet**  
Product code: P320  
4 pcs/CTN

**Well Outlet**  
Product code: P210  
4 pcs/CTN

**Round Well Cap**  
Product code: P220  
8 pcs/CTN

**Round Junction 75°**  
Product code: P180  
1 pc/CTN



## CLASSIC HALF-ROUND VINYL RAINWARE

## U-SNAP VINYL RAINWARE

### Classic Half Round Vinyl Rainware

Plastmo's Classic Half Round vinyl rainware exceeds the most stringent industry and government standards at all stages of manufacturing. Durable, scratch-resistant, easy-to-install, and very low-maintenance, the Plastmo line is complemented by a fully coordinated accessories line.

- Snap Together
- Durable
- Easy to Install

#### Classic Vinyl Gutter

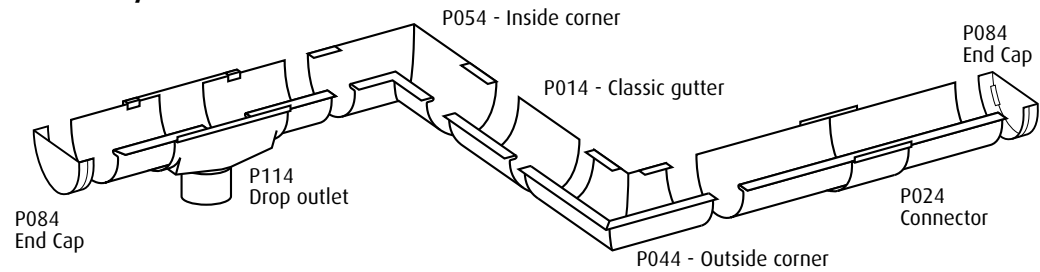

#### Classic Gutter

**Product code: P014**  
100 ft/CTN  
10 pcs/CTN  
Length: 10'

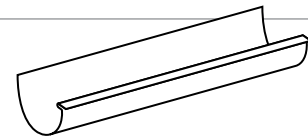

#### Classic Joint Connector

**Product code: P024**  
40 pcs/CTN

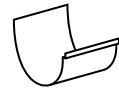

#### Classic Outside Corner

**Product code: P044**  
10 pcs/CTN

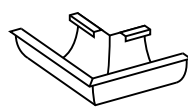

#### Classic Drop Outlet for Round Downspout

**Product code: P114**  
10 pcs/CTN

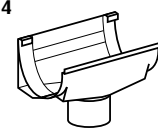

#### Classic Expansion Connector

**Product code: P034**  
10 pcs/CTN'

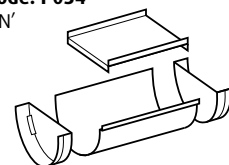

#### Classic Inside Corner

**Product code: P054**  
10 pcs/CTN

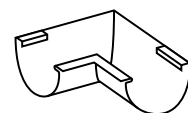

#### Classic Wedge 6/10 & 10/10

**Product code: P290**  
50 pcs/CTN

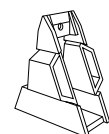

#### Classic End Cap

**Product code: P084**  
60 pcs/CTN

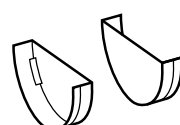

#### Classic Hanger

**Product code: P064**  
40 pcs/CTN

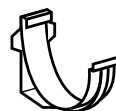

#### Classic Wedge 3/10 & 5/10

**Product code: P300**  
50 pcs/CTN

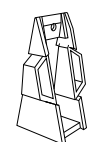

#### Classic Leaf Guard

**Product code: P250**  
20 pcs/CTN'  
Length: 1.5 m

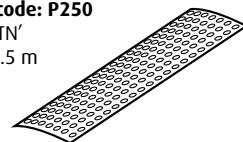

#### Cement

**Product code: P240**  
5 fl. Oz./Tube  
10 tubes/CTN

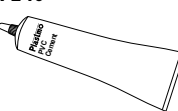

#### Classic Drip Edge

**Product code: P400**  
10 pcs/CTN'  
Length: 1.6 m

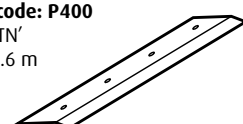

#### Available Colors



White



Brown

#### U-Snap Vinyl Gutter

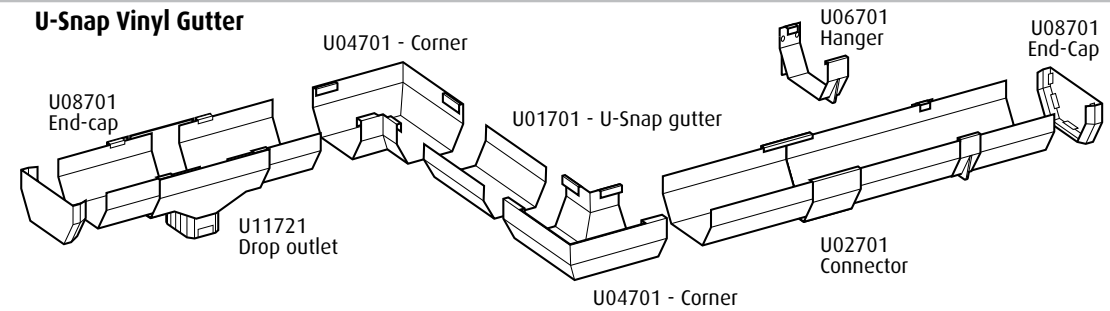

#### U-Snap Gutter

**Product code: U01701**  
100 ft/CTN  
10 pcs/CTN  
Length: 10'

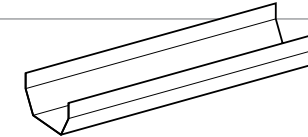

#### U-Snap Joint Connector

**Product code: U02701**  
20 pcs/CTN

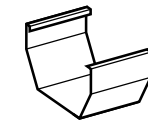

#### U-Snap Corner

**Product code: U04701**  
10 pcs/CTN

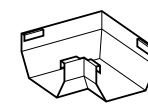

#### U-Snap Drop Outlet for Ribbed Downspout

**Product code: U11721**  
10 pcs/CTN

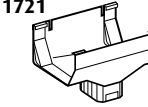

#### U-Snap Leaf Guard

**Product code: U25701**  
20 panels/CTN  
Length: 1.5 m

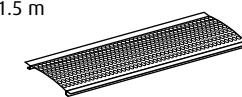

#### U-Snap Hanger

**Product code: U06701**  
75 pcs/CTN



#### U-Snap End Cap

**Product code: U08701**  
50 pcs/CTN



#### Available Color



White



### U-Snap Vinyl Rainware

U-Snap vinyl rainware is produced following Plastmo's stringent manufacturing standards. It offers the same physical properties of durability, scratch resistance, ease-of-installation and very low maintenance.

- Durable
- Easy to install

#### Downspout Diverter

**Product code: 2398**  
10 pcs/CTN

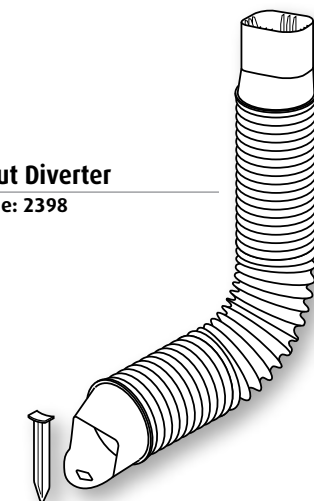





Architectural Accents, Vinyl and Aluminum Shutters, Roof Ventilation, Gable and Utility Vents, Window Headers and Door Surrounds, are just some of the additions to our product line that underscore our commitment, providing our customers with the quality and innovative products they need to meet the ever changing demands of today's building and remodeling industry.

## DECO-ARCHITECTURAL ELEMENTS

Kaycan deco-architectural products are offered in an unprecedented style, color and size selection to add character to any home. These deco-architectural elements are lightweight, easy to handle, and can be easily installed directly on wood, vinyl, aluminum, stucco, brick or hardboard.

Kaycan design accessories are engineered and manufactured to exacting standards. They are maintenance-free, won't crack, split or fade, and are backed by a 40 year warranty.

## VINYL SHUTTERS



### Vinyl Shutters

Add curb appeal in an instant with vinyl shutters that echo the warmth of wood and are extremely durable and maintenance free.

- SolidThru™ color holds up in all weather conditions and all climates.
- No scraping, sanding or painting ever needed.
- Available in custom styles and sizes, with one of the widest color palettes on the market.

#### Vinyl Decorator Colors

Natural (paintable #00),  
White (#69),  
Wineberry Red (#07),  
Forest Green (#14),  
Wedgewood Blue (#46),  
Clay (#51),  
Federal Brown (#28),  
Musket Brown (#04),  
Tuxedo Grey (#49),  
Midnight Green (#15),  
Midnight Blue (#24),  
Bordeaux (#40),  
Classic Blue (#02),  
Black (#13),  
Burgundy Red (#71),  
Wicker (#21)

Heights: any height from 24" to 144" in increments of 1/4".  
Solid colors, individually boxed and UPC bar coded.

#### Vinyl Shutters Models

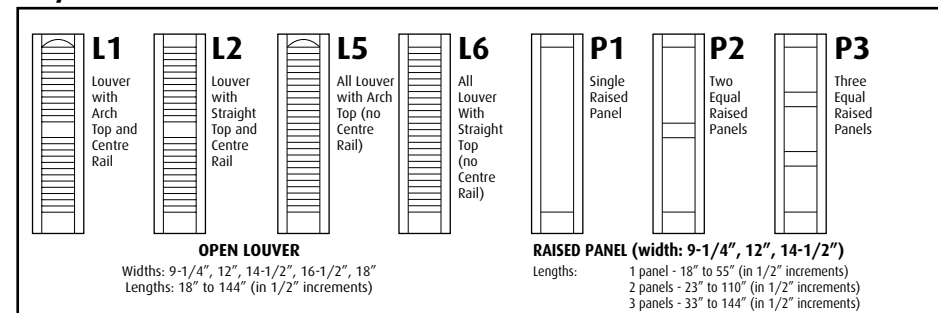

### Vinyl Shutters

Code	Description and dimensions
5009	9-1/4", 12" louver vinyl shutters (L1, L2, L5, L6)
5010	14-1/2" louver vinyl shutters (L1, L2, L5, L6) Cathedral top
5013	16-1/2" louver vinyl shutters (L1, L2, L5, L6) Cathedral top
5014	18" louver vinyl shutters (L1, L2, L5, L6) Cathedral top
4916	Williamsburg 1-panel vinyl shutters (P1, 9-1/2") 9 1/4
4917	Williamsburg 2-panel vinyl shutters (P2, 9-1/2") 9 1/4
4918	Williamsburg 3-panel vinyl shutters (P3, 9-1/2") 9 1/4
4919	Williamsburg 1-panel vinyl shutters (P1, 12")
4920	Williamsburg 2-panel vinyl shutters (P2, 12")
4921	Williamsburg 3-panel vinyl shutters (P3, 12")
5052	Williamsburg 1-panel vinyl shutters (P1, 14-1/2")

Code	Description and dimensions
5055	Williamsburg 2-panel vinyl shutters (P2, 14-1/2")
5053	Williamsburg 3-panel vinyl shutters (P3, 14-1/2")
4922	Williamsburg 1-panel vinyl shutters (P1 - 16 1/2")
4923	Williamsburg 2-panel vinyl shutters (P2 - 16 1/2")
4924	Williamsburg 3-panel vinyl shutters (P3 - 16 1/2")
4925	Williamsburg 1-panel vinyl shutters (P1 - 18")
4926	Williamsburg 2-panel vinyl shutters (P2 - 18")
4927	Williamsburg 3-panel vinyl shutters (P3 - 18")

### Custom Board-N-Batten Shutters (Special Order)

Code	Description and dimensions
5035	7" Two Board Joined Board-N-Batten
5037	10-1/2" Three Board Joined Board-N-Batten
5039	14" Four Board Joined Board-N-Batten
5044	14" Four Board Archtop Joined Board-N-Batten Note that length of 5044 includes Archtop
5041	17-1/2" Five Board Joined Board-N-Batten
5036	7-3/4" Two Board Spaced Board-N-Batten
5038	12" Three Board Spaced Board-N-Batten
5040	16-1/4" Four Board Spaced Board-N-Batten
5042	20-1/2" Five Board Spaced Board-N-Batten

Lengths:  
From 18" to 144" in 1/4" increments - lengths are nominal.  
Shutters under 55" in length will have two cross battens.  
Shutters 55" and over will have three cross battens.  
Style 5044 (14" four board archtop) is only available from 25" to 144" in 1/4" increments.  
Package: Shutters are boxed in pairs with screws.

Natural (paintable #30),  
White (#69),  
Wineberry Red (#78),  
Forest Green (#14),  
Wedgewood Blue (#04),  
Clay (#08),  
Federal Brown (#28),  
Musket Brown (#04),  
Tuxedo Grey (#49),  
Midnight Green (#15),  
Midnight Blue (#24),  
Bordeaux (#40)

### Joined Board-N-Batten Shutters (Special Order)

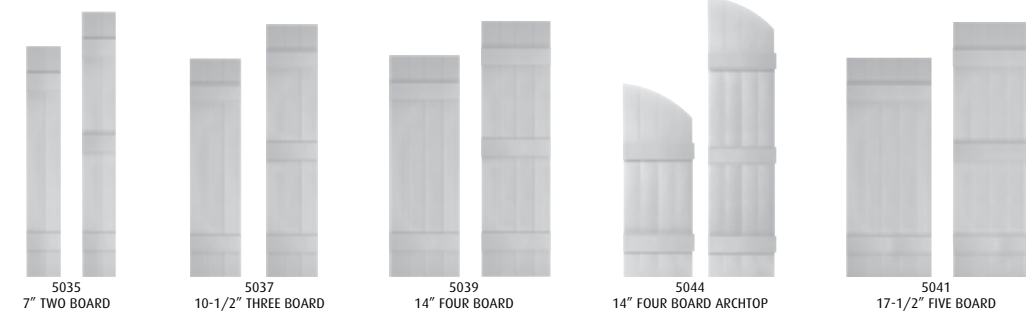

### Spaced Board-N-Batten Shutters (Special Order)

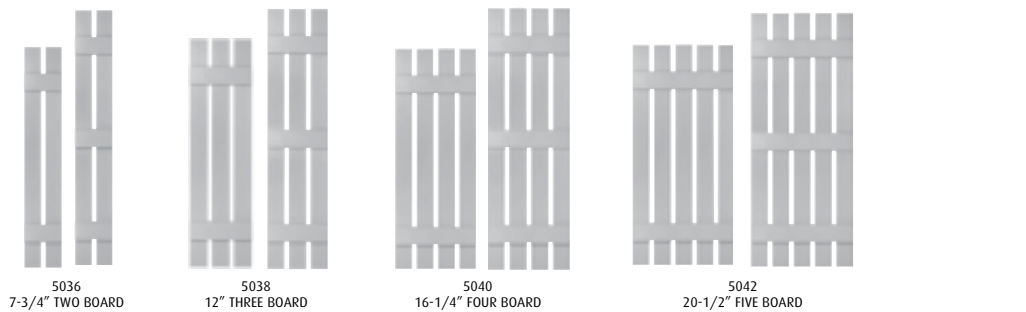

### Shutter Accessories (Special Order)

Product code: 500413  
Decorative Hinge and S-Hook  
4 hinges + 2 Hooks/Bag  
6 Bags/Box  
Available only in black



### Shutter Tops - Williamsburg (Special Order)

For use with Williamsburg raised panel shutters

Code	Description and dimensions
5585	12" Raised Quarter Round Arch Top Panel (pair with clips)
5056	14-3/4" Raised Quarter Round Arch Top Panel (pair with clips)
5057	14-3/4" Fanfold Quarter Round Arch Top Panel (pair with clips)
5043	14-3/4" Wide 6" Elliptical Arch Top Panel (pair with fasteners) B2



QUARTER ROUND ARCHTOP RAISED PANEL



QUARTER ROUND ARCHTOP FANFOLD



6" ELLIPTICAL ARCHTOP

### Shutter Tops - Louvered

For use with open louver shutters

Code	Description and dimensions
5059	14-1/2" X 17" Louver Quarter Round Arch Top Panel (pair with clips)
5058	Quarter Round Arch Top Solid 14.61" (2/Box)



QUARTER ROUND ARCHTOP OPEN LOUVER

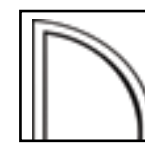

14-1/2" X 17"



## ALUMINUM SHUTTERS

### Aluminum Shutters

Kaycan aluminum shutters provide the perfect finishing touch and an architectural accent that adds value to any home. Kaycan shutters are coated with the same thermo-setting polyester Polycoat 9000™ topcoat used on Kaycan aluminum siding for a durable and fade resistant paint finish with the highest abrasion-resistant factor on the market.

- Made to measure
- Available in custom lengths



Board and Batten  
Product Code: 3012

Louvers  
Product Code: 3002

#### Aluminum Colors

White (#01),  
Pearl Grey (#03),  
Sandalwood (#05),  
Colonial Red (#07),  
Ivory (#08),  
Linen (#10),  
Chocolate Brown (#28),  
Black (#13),  
Forest Green (#14),  
Prestige Beige (#20),  
White SG (#25)  
Commercial Brown (#12),  
Slate Grey (#33),  
Chocolate Brown SG (#37),  
Mist Blue (#46),  
Charcoal (#49),  
Mocha (#68),  
MatchCoat Beige (#75),  
Sable (#77),  
MatchCoat Sandalwood (#85),



#### 6" Standard Headers (Special Order)

Code	Description	top width	bottom width	top depth	bottom depth	height
5560	33-5/8" Flat Panel	36-1/2"	33-5/8"	2-11/16"	1-1/4"	6"
5201	33-5/8" Classic Dentil	36-1/2"	33-5/8"	2-11/16"	1-1/4"	6"
5561	37-5/8" Flat Panel	40-1/2"	37-5/8"	2-11/16"	1-1/4"	6"
5202	37-5/8" Classic Dentil	40-1/2"	37-5/8"	2-11/16"	1-1/4"	6"
5562	43-5/8" Flat Panel	46-1/2"	43-5/8"	2-11/16"	1-1/4"	6"
5203	43-5/8" Classic Dentil	46-1/2"	43-5/8"	2-11/16"	1-1/4"	6"
5563	65-5/8" Flat Panel	68-1/2"	65-5/8"	2-11/16"	1-1/4"	6"
5204	65-5/8" Classic Dentil	68-1/2"	65-5/8"	2-11/16"	1-1/4"	6"
5564	73-5/8" Flat Panel	76-1/2"	73-5/8"	2-11/16"	1-1/4"	6"
5192	73-5/8" Classic Dentil	76-1/2"	73-5/8"	2-11/16"	1-1/4"	6"

#### Headers

Vinyl headers are an easy way to add architectural flair to your home. Match the color to the shutters or to the siding for a multitude of beautiful design combinations.

- Available in Flat Panel or Classic Dentil profiles.
- Keystone shipped with the header for optional application.
- Simple two-piece construction.
- SolidThru™ color holds up in all weather conditions and all climates.

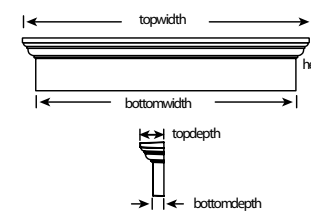

#### 9" Standard Headers (Special Order)

Code	Description	top width	bottom width	top depth	bottom depth	height
5554	33-5/8" Flat Panel	37-7/8"	33-5/8"	3-3/4"	1-5/8"	9"
5555	37-5/8" Flat Panel	41-7/8"	37-5/8"	3-3/4"	1-5/8"	9"
5556	43-5/8" Flat Panel	47-7/8"	43-5/8"	3-3/4"	1-5/8"	9"
5557	65-5/8" Flat Panel	69-7/8"	65-5/8"	3-3/4"	1-5/8"	9"
5558	73-5/8" Flat Panel	77-7/8"	73-5/8"	3-3/4"	1-5/8"	9"
5210	73-5/8" Classic Dentil	77-7/8"	73-5/8"	3-3/4"	1-5/8"	9"
5200	128" Flat Panel	132-7/8"	128"	3-3/4"	1-5/8"	9"

Profiles: Flat Panel or Classic Dentil.  
Installation: Surface Mount on any surface.  
Solid one-piece construction. Keystone shipped with the header for optional application.  
Can be cut in the centre for special sizing in the field. Keystone would be used to cover the cut.

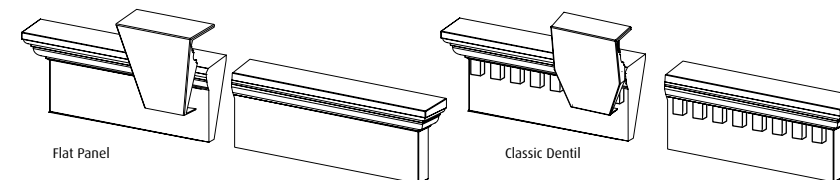

#### Aluminum Shutters, Regular width 14"

Aluminum shutters are available in standard 14" width and in lengths varying between 20" and 144" in 1/2" increments.

## DOOR SURROUNDS

## GABLE VENTS

### Door Surrounds

Frame any entrance with a classic accent, adding a look of distinction. Enhance patio doors, garage doors and front doors with a Door Header and Pilasters. Extra tall openings up to 8½ feet can be accommodated.

- Door headers available in Flat Panel and Classic Dentil profiles in most sizes.
- SolidThru™ color for scratch resistance and ultra durability.

### Door Surround and Pilaster Kit (Special Order)

**Code** Description  
**5710** Pilaster Kit  
**Package:**  
 Door Surrounds are comprised of a 6" or 9" Header with a Pilaster Kit which are sold separately.  
 Pilaster dimensions: 96" X 6-7/8" X 1-7/8".  
 Accommodates extra tall opening up to 8-1/2 feet.

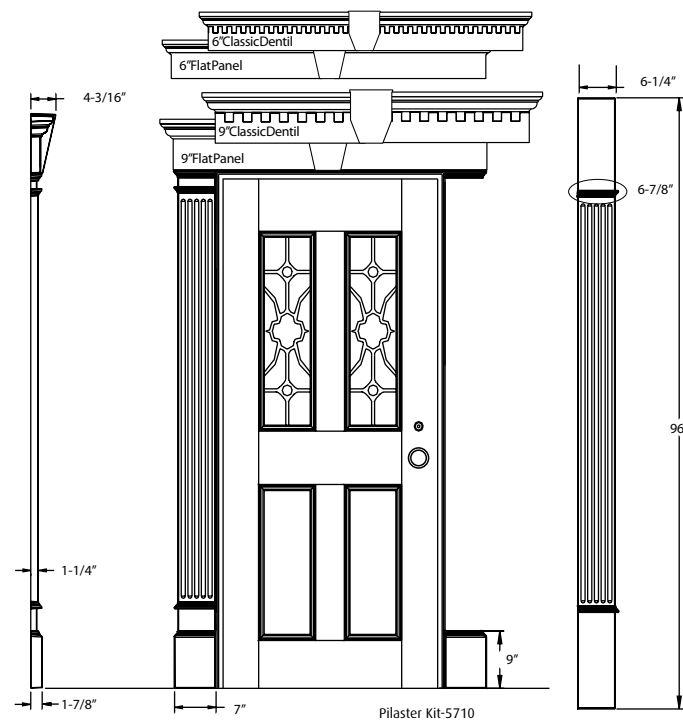

### Brickmold

**Product Code:**  
**M00041**  
 180 ft/CTN  
 10 pcs/CTN  
 Length: 18'

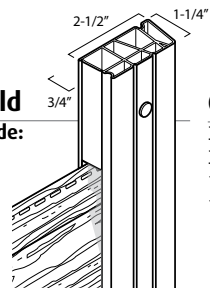

### Common Door Sizes:

32" Door = 51-1/2" Header  
 36" Door = 55-1/2" Header  
 10' Door = 139-1/2" Header  
 16' Door = 211-1/2" Header

These overall dimensions assume:  
 4" for brick mold;  
 14" for pilasters  
 1-1/2" for transition pieces

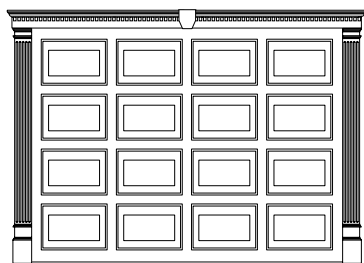

Garage Door Surround with 6" Header  
 Up to 144" Classic Dentil Profile

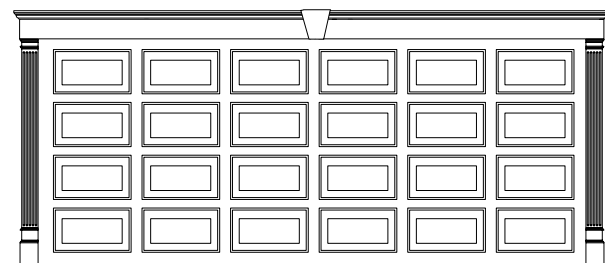

Garage Door Surround with 9" Header  
 Up to 256" Flat Panel Profile

Consult your local Kaycan distribution centre for product availability

### Gable Vents

Code	Description and locking positions	Outside Dimensions	Depth	Venting Area	Rough Air Opening
5082	14" X 22" Round Top (K) - .5", .75", 1", 1.25"	16" X 24"	2.187"	50 sq.in.	8" x 8"
5087	22" X 32" Round Top (K) - .5", .75", 1", 1.25"	22" X 32"	2.187"	70 sq.in.	9" x 9"
5072	21" X 27" Oval - .75", 1", 1.25", 1.50"	21" X 27"	2.175"	57 sq.in.	8" x 8"
5069	18" Octagon - .75", 1", 1.25", 1.50"	18" width	2"	26 sq.in.	5" x 6"
5081	22" Octagon (K) - .75", 1", 1.25", 1.50"	22" width	2"	54 sq.in.	7" x 8"
5071	27" Octagon (K) - .75", 1", 1.25", 1.50"	27" width	2"	81 sq.in.	9" x 9"
5079	32" Octagon (K) - .75", 1", 1.25", 1.50"	32" width	2"	110 sq.in.	10" x 11"
5090	18" Round - 0", .25", .5", .75", 1", 1.25", 1.50"	18" diam.	2"	26 sq.in.	5" x 6"
5080	22" Round - .75", 1", 1.25", 1.50"	2" diam.	2"	54 sq.in.	7" x 8"
5076	36" Round - .75", 1", 1.25", 1.50"	36" diam.	2"	140 sq.in.	12" x 12"
5083	22" X 34" Half Round (K) - .75", 1", 1.25", 1.50"	22.1" X 34.2"	2.1"	100 sq.in.	10" x 10"
5085	12" X 12" Square - .75", 1", 1.25", 1.50"	14.2" X 14.2"	1.75"	38 sq.in.	6" x 6"
5084	12" X 18" Rectangle - .75", 1", 1.25", 1.50"	14" X 20"	1.75"	49 sq.in.	7" x 7"
5068	12" X 18" Rectangle Replacement - .5", .75", 1"	14" X 20"	1.75"	52 sq.in.	8" x 8"
5077	18" X 24" Rectangle Style (K) - .5", .75", 1", 1.25"	20.2" X 23.2"	2.18"	63 sq.in.	8" x 8"
5089	18" X 24" Rectangle Classic - .5", .75", 1", 1.25"	20.2" X 26"	1.75"	140 sq.in.	12" x 12"

(K) = Keystone available, field modifications may have to be made.

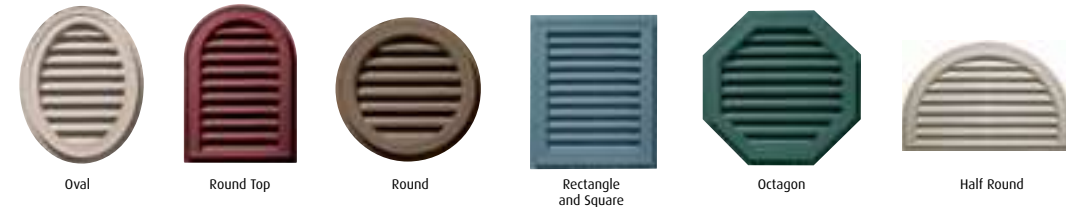

### Gable Vent Keystone for Standard Vents (Special Order)

Product code: 5075



### Designer Series Gable Vents (Special Order)

Code	Description and locking positions	Outside Dimensions	Depth	Venting Area	Rough Air Opening
5588	Designer 30" Round with Keystones - 0", .25", .5", .75", 1", 1.25"	30" Diam.	2.156"	50 sq.in.	8" x 8"
1135	Designer 28" Round without Keystones - 0", .25", .5", .75", 1", 1.25"	28.25" Diam.	2.156"	50 sq.in.	8" x 8"



30" Round with Keystone - 5588

28" Round without Keystone - 1135

Consult your local Kaycan distribution Centre for product availability



### Gable Vents

Performance, style, versatility and protection. Kaycan Gable Vents have more Net Free Ventilation Area for optimal venting than industry standards. They provide added architectural detail with their woodgrain finish and sharp distinctive features.

- Can be installed on all types of siding.
- Double baffle design provides added protection against wind-driven rain and snow.
- Easy-to-use in a decorative application if a functioning vent is not required.



## MOUNT BLOCKS

### Mount Blocks and Utility Vents

These mount blocks and utility vents are the industry standard for mounting all exterior fixtures on any surface. Distinctive style and matching colors paired with durability and easy installation make these the mounting blocks of choice.

- Conceal the cut edges of siding for a finished, professional look.
- Eliminate moisture and air infiltration.
- Available in all Kaycan siding colors.

#### Original MountMaster

**Product code Square: 1118**  
10 pcs/BOX  
Locking positions - .75", 1.00", 1.25"  
**Product code Scalloped: 1128**  
10 pcs/BOX  
Locking positions - .75", 1.00", 1.25"

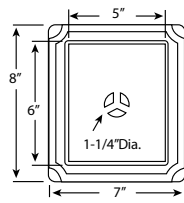

#### Jumbo Mount

**Product code: 1125**  
10 pcs/BOX  
Locking positions - .75", 1.00", 1.25"

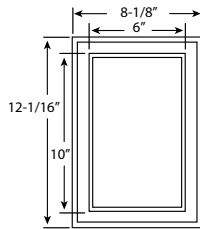

#### Super Jumbo Mount

**Product code: 1134**  
1 pc/Box  
Locking positions - .75", 1.00", 1.25"

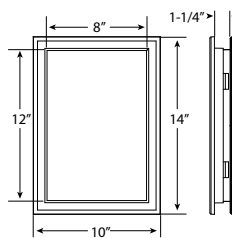

#### Slim Line Mount

**Product code: 1127**  
10 pcs/BOX  
Locking positions - .50", .75"

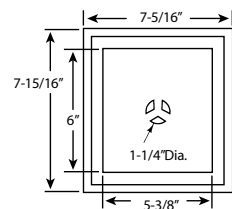

#### Large Recessed Mount

**Product code: 1143**  
5 pcs/BOX  
Locking positions - .625", .875"

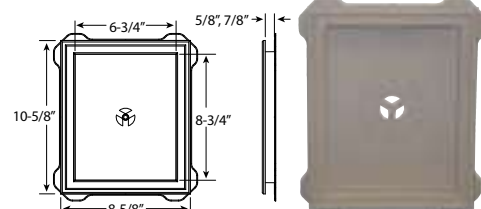

#### Recessed Jumbo Mount

**Product code Scalloped: 1142**  
10 pcs/BOX  
Locking positions - .625", .875"

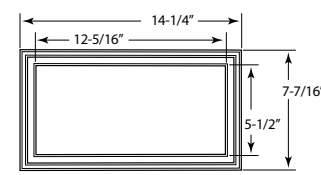

#### Recessed Square Mount

**Product code: 1147**  
10 pcs/BOX  
Locking positions - .625", .875"

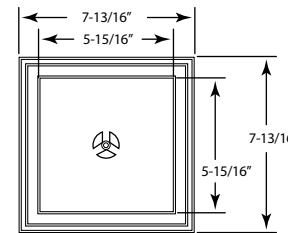

#### Recessed Mini Mount

**Product code: 1126**  
10 Pc/BOX  
Locking positions - .75", 1.00", 1.25"

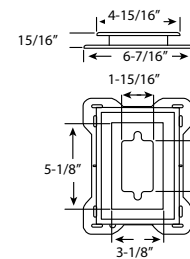

#### Meter Block

**Product code: 5625**  
1 Pc/BOX

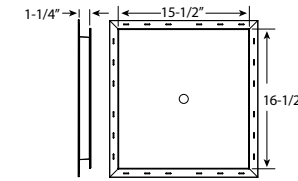

#### Jumbo Meter Block

**Product code: 5623**  
1 Pc/BOX

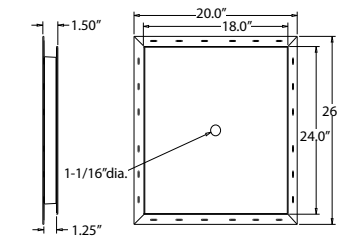

#### Mini Mount

**Product code: 1116**  
10 pcs/BOX  
Locking positions - .50", .85"

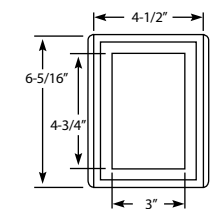

#### Split Block Mini Mount

**Product code: 1148**  
10 pcs/BOX  
Locking positions - .75", 1.00", 1.25"

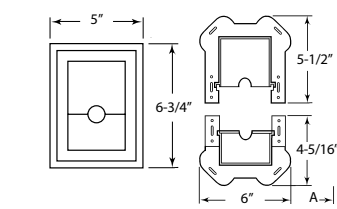

## SPECIALITY MOUNT BLOCKS & VENTS

### Mount Blocks and Utility Vents

These mount blocks and utility vents are the industry standard for mounting all exterior fixtures on any surface. Distinctive style and matching colors paired with durability and easy installation make these the mounting blocks of choice.

- Conceal the cut edges of siding for a finished, professional look.
- Eliminate moisture and air infiltration.
- Available in all Kaycan siding colors.

#### Electrical Block\*

**Product code: 5626**  
(Special Order - 3 to 4 weeks delivery)  
2 pcs/BOX  
Locking positions  
- .875", 1.125", 1.375", 1.625"

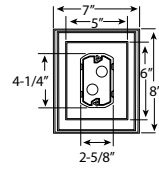

#### Jumbo Electrical Block\*

**Product code: 5624** (Special Order)  
2 pcs/BOX  
Locking positions  
- .875", 1.125", 1.375", 1.625"

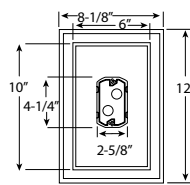

#### Jumbo Electrical Block - Offset\*

**Product code: 5622** (Special Order)  
2 pcs/BOX  
Locking positions  
- .875", 1.125", 1.375", 1.625"

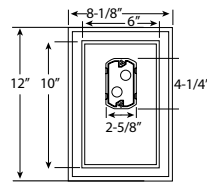

#### Super Jumbo Electrical Block\*

**Product code: 5630**  
2 pcs/BOX

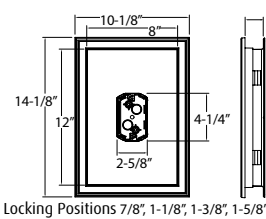

\*Can be used on standard or insulated siding.  
Electrical mounting block with UL listed 18 cu.in. outlet box

Consult your local Kaycan distribution centre for product availability



### 4" Hooded Vent for Insulated Siding

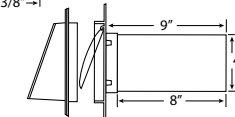
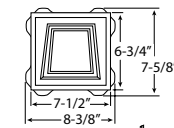

1-A Dimension "A" Locking Positions  
.75, 1.00, 1.25

**Product code: 5684**  
Special Order - 3 to 4 weeks delivery  
Concealed exhaust flap.  
Includes 8" long aluminum tube (4" diam.)  
12 sq.ft. net free area  
1 pc/BOX

### Original MountMaster for Insulated Siding

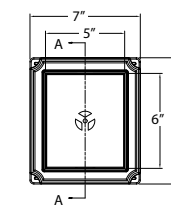

Locking Positions  
7/8", 1-1/8", 1-3/8", 1-5/8"

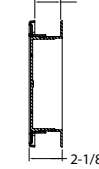

**Product code Scalloped: 5688**  
Special Order - 3 to 4 weeks delivery  
10 pcs/BOX

### Jumbo Mount for Insulated Siding

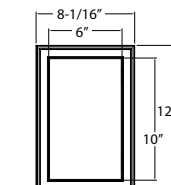

Locking Positions  
7/8", 1-1/8", 1-3/8", 1-5/8"

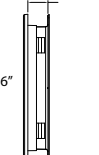

**Product code: 5689**  
Special Order - 3 to 4 weeks delivery  
10 pcs/BOX

Consult your local Kaycan distribution centre for product availability





## SPECIALITY VENTS

### Mount Blocks and Utility Vents

These mount blocks and utility vents are the industry standard for mounting all exterior fixtures on any surface. Distinctive style and matching colors paired with durability and easy installation make these the mounting blocks of choice.

- Conceal the cut edges of siding for a finished, professional look.
- Eliminate moisture and air infiltration.
- Available in all Kaycan siding colors.

### Utility Vents



#### 4" Hooded Vent

**Product code: 1150**  
1 pc/BOX

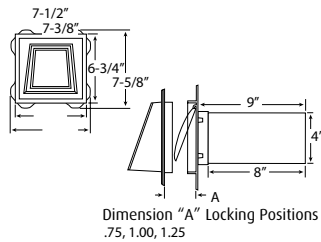

#### Small Animal Guard for 4" Hooded Vent

**Product code: 1139**  
1 pc/BOX

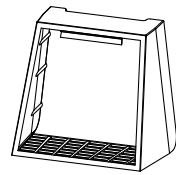

Optional Small Animal Guard  
Nor for Dryer Vent



#### 6" Hooded Vent

**Product code: 1141**  
1 pc/BOX  
Concealed exhaust flap.  
Wire screen included  
Includes 8" long aluminum tube.  
25 sq.ft. net free area

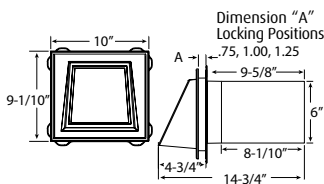

#### 8" Hooded Vent

**Product code: 1136**  
(Special Order - 3 to 4 weeks delivery)  
1 pc/BOX  
Meets the increased air flow requirements of newer high efficiency HVAC systems.  
Can be installed with an 8" or 7" diameter tube (not included).  
Adapter for 7" diameter tube is included.  
Concealed exhaust  
48 sq.ft. net free area  
Locking positions - .50", .75"

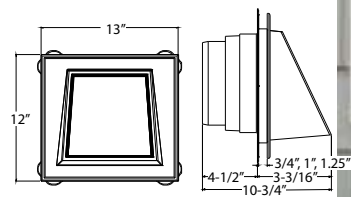

#### Master Exhaust Vent

**Product code Scalloped: 1124**  
**Product code Square: 1119**  
4 pcs/BOX  
Locking positions - .75", 1.00", 1.25"

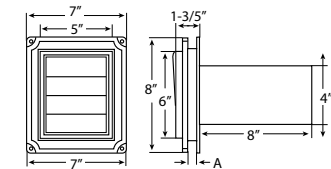

#### Small Animal Guard for Master Exhaust Vent

**Product code: 1138**  
(Special Order - 3 to 4 weeks delivery)  
Use in place of the trim ring.  
Order in addition to the Master Exhaust Vent  
1 pc/BOX

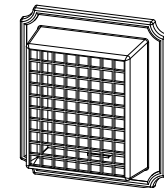

#### Master Intake/Exhaust Vent

**Product code: 1149**  
Full fiberglass screening.  
Not for use as a dryer or furnace vent  
Snap-in Modular Vent Tube  
adjusts from 1 1/2" to 8" and comes with 4"-3" reducer.  
12 sq.ft. net free area  
1 pc/BOX  
Locking positions - .625", 1.00", 1.25"

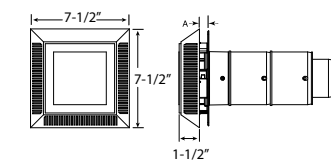

Consult your local Kaycan distribution centre for product availability





With insulation, sealants and nails available from the same supplier as your siding, rainware, trim and architectural accessories, Kaycan is a one-stop shop when it comes to finishing a house's exterior.

Kaycan's StyroFold 5 Plus and Sure-Wrap insulation products provide a sound nailing base for your siding and help straighten walls on renovation projects. They help prevent air infiltration, keep wall cavities dry and your home comfortable year round.

## INSULATION, SEALANTS, FASTENERS AND ROOF VENTILATION



## INSULATION SEALANTS AND FASTENERS

INSULATION SEALANTS AND FASTENERS

### StyroFold 5 Plus - foil/white

Product code 3/8": 063000

Product code 3/4": 064100

Product code 1": 064300



### Kaycan House

Product code: 0652

9' X 100'/Roll  
108 rolls/SKID

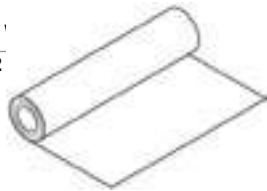

### Tar Paper

Product code: 0650

400 sq.ft./ROLL  
108 rolls/SKID

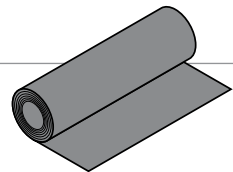

### Air Barrier & Waterproof Membrane 4"

Product code: 069600

4" X 75' Roll



### Air Barrier & Waterproof Membrane 6"

Product code: 069700

6" X 75' Roll



Consult your local Kaycan distribution centre for product availability

### Stainless Steel Trim Nails

1 lb/BOX

Product code: 2010XX

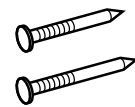

### Aluminum Siding Nails

1 lb/BOX

1-1/2" Product code: 2007



### Electro Galvanized Nails

50 lbs/BOX

1" Product code: 202900

1-1/4" Product code: 202950

1-1/2" Product code: 200500

2" Product code: 203000

2-1/2" Product code: 203100

3" Product code: 203200

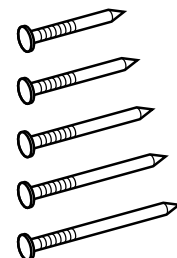

### Sealant - Tremco 830

Product code: 2071

20 tubes/BOX

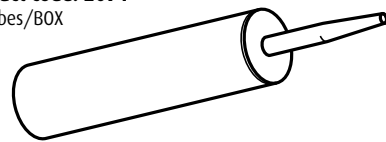

### Gutter Seallant - Tremco

Product code: 2058

30 tubes/BOX

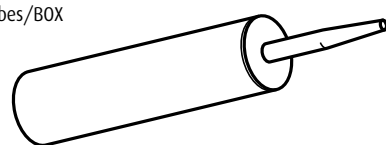

### Silicone

Product code: 2059

White, Clear or Bronze

12 tubes/BOX



### Tools of the Trade

Kaycan offers a full line of specialty hand tools, benders and gutter machines to ease any installation.



Gutter Machines

Brakes and Accessories



Ridgmaster and Ridgmaster Plus



### 9" RidgeMaster Plus

Product code: 8801

Patented added pitch shows more shingle profile and less vent opening. Patented internal baffle engineered to keep blowing snow and rain from entering.

40 ft/BOX - 10 pcs/BOX - 18 boxes/SKID - Length: 4'

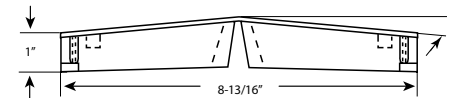

### 11" RidgeMaster Plus

Product code: 8802

For roof pitches from 3/12 to 12/12. Patented added pitch shows more shingle profile and less vent opening. Patented internal baffle engineered to keep blowing snow and rain from entering.

40 ft/BOX - 10 pcs/BOX - 21 boxes/SKID - Length: 4'

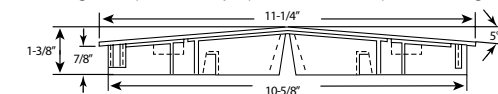

### CapMaster (Special Order)

Product code: 5060

All 3" and 4" vent pipes.

Adapts to all roof pitches from 3/12 to 12/12

1 per box

Available in: Black (13), Grey (03) and Brown (04)

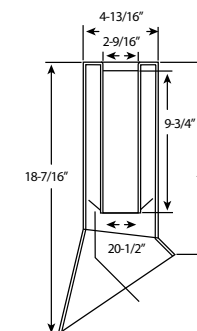

### HipMaster Starter Piece (Special Order)

Product code: 8807

Blends HipMaster into roof line at bottom or top of hip. Use for 11" HipMaster or 9" HipMaster. 4 pcs/BOX - Length: 20 1/2"

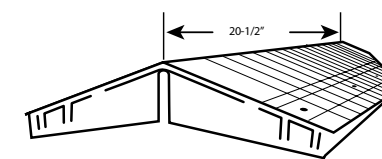

### RidgeMaster End Gasket

Product Code: 861000

16 pcs/CTN

### 9" HipMaster Plus (Special Order)

Product code: 8805

For 9" hip and ridge. Patented triple baffle engineered to keep blowing snow and rain from entering. Can be joined with RidgeMaster Plus. 40 ft/BOX - 10 pcs/BOX - 18 boxes/SKID - Length: 4'

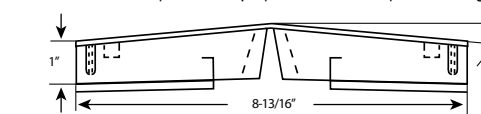

## Roof Ventilation

Ridgmaster®, Ridgmaster Plus® and Hipmaster®'s patented baffle system works efficiently regardless of wind direction or speed and excels in keeping out weather and insects. Its patented structural ribs make it virtually crush proof.

- Nailing supports and structural ribs designed to ensure a smooth straight roofline.

- Durable copolymer material withstands dents from branches or hammer blows and resists cracking regardless of temperature.

- 40 year limited warranty.

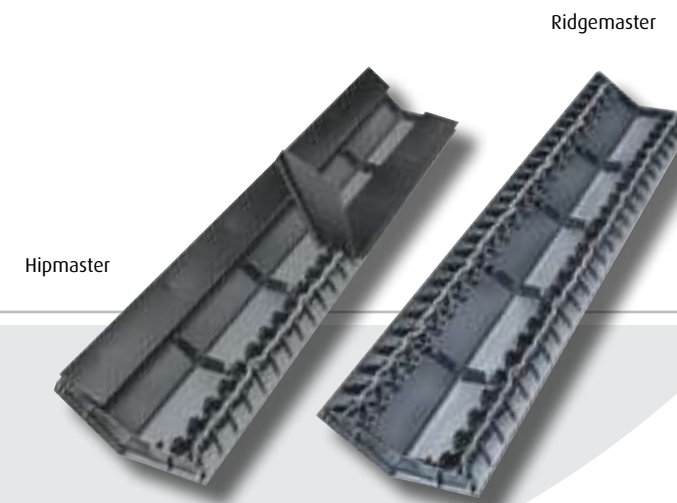

Hipmaster

Ridgmaster

DECO-ARCHITECTURAL ELEMENTS

Consult your local Kaycan distribution centre for product availability

## WEB SITE CUSTOMER SUPPORT

### Kaycan Web Site

The complete reference for all Kaycan products, regularly updated to be a constant source of information and a valuable resource for you and your customers.

Also available on the Kaycan website are 2 easy-to-use applications:

### Home Designer 2.0 Watch your project come to life with a few clicks.

- Visualize what a variety of homes will look like with the selected siding and accessories using the Home Designer application.

### Vinyl Siding Estimator

- Determine the quantity of siding and accessories required through the Vinyl Siding Estimating Guide.

### Be Inspired

Discover our :

- On Trend Colors
- Color Combinations
- Photo Gallery

### www.kaycan.com

Home Page



Main Products page



Main Vinyl page



Product page



Color page



Home Designer 2.0 page



Every effort has been made to make the colors in this application as accurate as possible. However, due to variables such as individual monitor settings, we recommend that you make final color decisions using actual vinyl samples.

### Stay connected with Kaycan

Kaycan Blog > [www.info.kaycan.com](http://www.info.kaycan.com)



[www.facebook.com/KaycanSiding](https://www.facebook.com/KaycanSiding)



[@kaycan74](https://twitter.com/kaycan74)



Visit us on our social media platforms:

