

NUOMI诺米

NUOMI诺米

广东诺米家居智能科技有限公司  
GUANGDONG NUOMI HOME INTELLIGENT TECHNOLOGY CO.,LTD

地址：佛山市南海区丹灶镇丹灶物流中心金泰路3号

Add : No.3,JinTai RD,Danzao Town,Foshan City,Guangdong Province,China

电话Tel: 0757-86602177 (总机) 传真Fax: 0757-86602166

服务热线Service Hotline: 400-831-7997 邮政编码Postal Code: 528000

网址Web: www.gz-nuomi.com 邮箱E-mail: nx02@gz-nuomi.com



公众号



服务号

产品如有改动，请以实物为准 2023年5月第一次印刷

NUOMI诺米



诺米高端基础五金系统

HIGH-END FURNITURE MOTION SOLUTIONS

诺米高端基础五金系统

# HIGH-END FURNITURE MOTION SOLUTIONS

诺米高端基础五金系统



**NUOMI** 诺米





NUOMI MAKE YOUR HOME LIFE MORE TASTEFUL

## 诺米 · 让家居生活更有品位!

NUOMI 诺米, 成立 2003 年, 是一家集研发、设计、生产、销售于一体的高新技术企业。

NUOMI, founded in 2003 and is a high-tech enterprise that integrates research and development, design, production, and sales.

作为中国高端家居五金领军品牌之一, 诺米首创并践行「全屋五金生态链」理念, 以同风格、同颜色、同品质、同品牌的“四同法则”实现五金颜值的设计跃级, 并全面布局“橱柜功能五金、衣柜收纳五金、精工水槽、基础五金、智能照明、铝材高定应用”六大产品体系。

As one of China's leading high-end home hardware brands, NUOMI pioneered and practices the concept of "whole-house hardware ecological chain." It uses the "four-same" concept of the same style, same color, same quality, and same brand to achieve design upgrades in hardware aesthetics and has fully laid out six major product systems, including "kitchen storage solutions, wardrobe storage solutions, kitchen sink, furniture motion solutions, smart lighting system and high-end custom aluminum application system."

多年发展以来, 诺米集聚全球研发智慧推出多项创新技术与五金方案, 至今拥有 200 多项创新设计专利, 产品先后通过英国皇冠 ISO9001、瑞士 SGS、德国 TÜV 等国际权威质量检测认证。凭借工业 4.0 智造转型, 诺米在行业内率先打造 80000 m<sup>2</sup> (I 期) 与 60000 m<sup>2</sup> (II 期建设中) 智能生产基地, 广泛配备智能机器人、自动化设备、无人仓储系统, 用科技力量赋能五金的柔性化精密生产, 全方位提升交付实力, 并因此斩获“国家高新技术企业”“制造业全国隐形冠军”“家居智造标杆品牌”等多项荣誉。

Over the years, NUOMI has gathered global research and development intelligence and launched many innovative technologies and hardware solutions. It currently holds more than 200 innovative design invention patents and has obtained international authoritative quality certification such as the UK Crown ISO9001, Swiss SGS, and German TÜV for its products. With the transformation of Industry 4.0 intelligent manufacturing, NUOMI took the lead in building an 80,000 square meter (Phase I) and 60,000 square meter (under construction Phase II) intelligent production base in the industry, equipped with intelligent robots, automation equipment, and unmanned storage systems. It uses technology to empower the flexible and precise production of hardware, comprehensively improving delivery capabilities and winning many honors such as "National High-tech Enterprise," "National Invisible Champion of Manufacturing Industry," and "Benchmark Brand of Home Furnishing Intelligent Manufacturing."

通过全方位的能力建构, 诺米成为行业内为数不多能提供一站式、一体化配齐方案的高端全屋五金服务商。截至目前, 面向全球市场的诺米, 现已成为全球众多橱柜品牌和家居品牌的主力供应商, 业务遍及全球 70 多个国家和地区。在中国地区, 诺米与一线上市家居品牌建立战略合作, 全国拥有 200 多个销售服务网点, 品牌实力位居行业前列。

Through comprehensive capacity building, NUOMI has become one of the few high-end whole-house hardware service providers in the industry that can provide one-stop, integrated matching solutions. As of now, NUOMI, which is facing the global market, has become a major supplier to many cabinet and wardrobe brands and home furnishing brands worldwide, with business covering more than 70 countries and regions around the world. In the Chinese market, NUOMI has established strategic cooperation with top-listed home furnishing brands, and its sales network has more than 200 dealers and agents, making it one of the leading brands in the industry.

2023 年, 诺米全新品牌形象焕新而至, 并签约唐嫣为品牌代言人, 开启品牌的跃升新程。

In 2023, NUOMI will unveil a brand new logo and brand image, and signed Tang Yan as the brand spokesperson, opening a new era of brand development.







NUOMI 诺米

唐嫣  
诺米全屋五金品牌代言人

「嫣」值美家  
共同奔赴



橱柜功能五金系统 KITCHEN STORAGE

衣柜收纳五金系统 WARDROBE STORAGE

精工水槽系统 KITCHEN SINK

基础五金系统 FURNITURE MOTION HARDWARE

智能照明系统 SMART LIGHTING

铝材高定应用系统 ALUMINUM APPLICATION

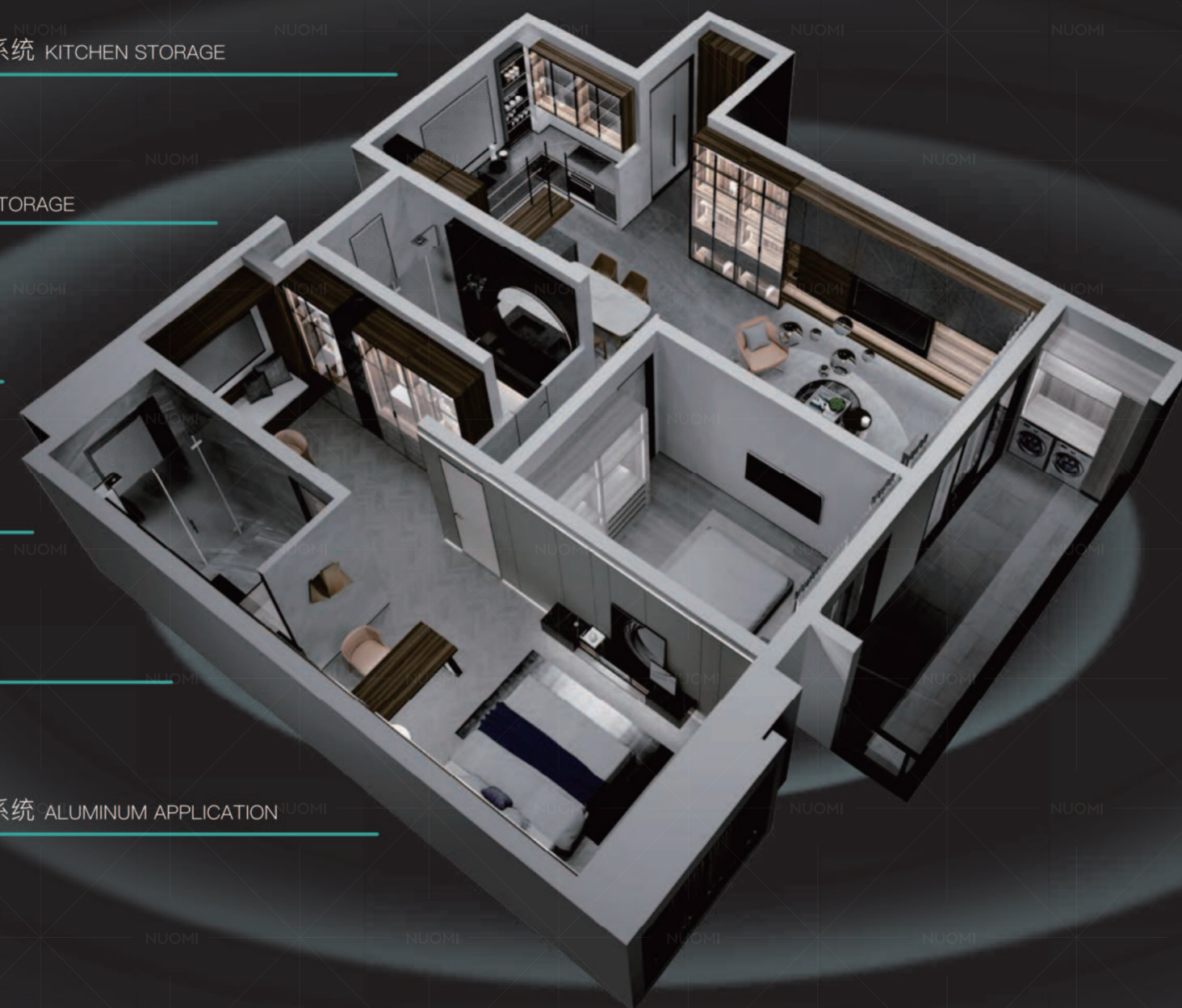

## DESIGN CONCEPT

### 四同法则



#### 同[风格]

极简轻奢贯穿全屋五金设计,美学风格协调统一,实现整家搭配的审美提升。

#### SAME STYLE

Minimalist light luxury runs through the hardware design of the whole house,coordinated aesthetic style, realize the aesthetic improvement of the whole home collocation.



#### 同[颜色]

全屋五金不同配件保持同一色系,同色率达95%以上,满足高定家居的细节要求。

#### SAME COLOR

Keep the same color system for different hardware accessories in the whole house,the same color rate is over 95%,meet the detailed requirements of high-end home furnishing.



#### 同[品质]

全屋五金由诺米4.0基地制造出厂,数智化、自动化产线高标交付,7级质检把控产品一致性。

#### SAME QUALITY

The whole house hardware is manufactured by NUOMI 4.0 production base, the factory is digitized and automated. The production line is delivered with high standards and 7 levels of quality inspection to control product consistency.



#### 同[品牌]

全屋五金无需东拼西凑,诺米全系自研自产,多品类一站省心配套。

#### SAME BRAND

The whole house hardware does not need to be pieced together,NUOMI full system products are self-developed and self-produced, multi-category one-stop worry-free support.

## NUOMI DESIGN - 诺米设计

诺米基于极简主义“少即是多 (Less is more)”的设计哲学,以全屋产品体系、至臻工艺细节、全球高阶审美,顺势推出“四同法则”,为全屋五金融入轻奢范式,满足更高阶奢居的定制所需。

NUOMI is based on the design philosophy of “Less is more”, and with a complete home product system, exquisite craftsmanship details, and global high-end aesthetics, it has launched the “Four-Same” concept to integrate whole house hardware into a minimalist and luxurious paradigm, meeting the needs of high-end custom homes.



### 全屋五金 整家奢配

Whole house hardware  
the whole house is luxuriously matched.

6 大品类  
6 major categories

独立研发团队“赛马”式创新  
Independent R&D team with "horse racing" style innovation.

200+ 项

创新设计专利改进产品使用体验  
Innovative design patents improve the user experience of the product.

3000+ 个

3000 items

产品 SKU 满足细分需求  
Product SKU meet specific segmentation demands.

### 科技智造 双擎加速

Intelligent manufacturing with technology  
dual-engine acceleration.

80000 m<sup>2</sup>

国际 4.0 数智化生产基地  
International Industry 4.0 digital intelligence production base.

60000 m<sup>2</sup>

高端基础五金智造基地  
The high-end furniture motion intelligent manufacturing base.

2014-2016 连续三年被评为“五金行业十大品牌”

2019 年 荣获国家级《高新技术企业证书》

2021 年 被全国工商联家具装饰业商会评为《中国家居优选供应链百强》

2021 年 被全国工商联家具装饰业商会评为《战略合作伙伴》

2022 年 被评为南海制造业全国隐形冠军

2022 年 斩获“家居智造标杆品牌”、“设计创新奖”、“技术领先奖”

2022 年 入选佛山市专精特新企业

2022 年 认定为佛山市高端全屋定制五金（诺米家居）工程技术研究中心

Was rated as "Top Ten Brands in the Hardware Industry" for three consecutive years from 2014 to 2016

Won the national "high-tech enterprise certificate" in 2019

Was rated as "Top 100 Chinese Home Furnishing Supply Chain Companies" by the China Furniture & Decoration Chamber of Commerce in 2021

Was rated as "Strategic Partner" by China Furniture & Decoration Chamber of Commerce in 2021

Named the National Invisible Champion of Nanhai Manufacturing Industry in 2022

Won the "Benchmark Brand of Smart Home Manufacturing", "Design Innovation Award", and "Technology Leadership Award" in 2022

Selected as a Specialized and Innovative New Enterprise in Foshan in 2022

Identified as Foshan High-end Customization of Whole House Hardware (Nuomi Home ) Engineering Research Center in 2022





诺米智能生产基地 II 期  
NUOMI intelligent production base phase II



尖端 CNC 精密加工中心  
Cutting-edge CNC precision machining center



激光切割自动化产线  
Laser cutting automatic production line



诺米智能生产基地  
NUOMI Intelligent Production Base



智能无人立体仓库  
Intelligent unmanned three-dimensional warehouse



全自动焊接机械臂  
Fully automatic welding robot arm

0.01

0.01cm 精控误差，追求卓越品质的产品契合。  
0.01Cm precision control pursue excellent quality.

3

3 重国际权威品质认证，英国 ISO+ 瑞士 SGS+ 德国 TÜV。  
3 international authoritative organization for quality certification:  
ISO, SGS, TÜV

7

7 级质检把控，从原料到成品，每一件产品历经层层检测，严控质量是诺米提供给消费者的可靠性保证。  
7 level quality control, from raw materials to finished products, each product after layers of testing, strict quality control is the reliability guarantee that NUOMI provides to consumers.

10

导轨 10 年至终身质量保障，让用户时刻无忧。  
Slide-10 Years quality assurance, reassure users.

168

纳米干镀表面处理技术，通过 168 小时盐雾测试，持久光亮不生锈。  
Dry-plating technology, pass 168 hours salt spray test, lasting bright and rust-resistant.

80000

导轨通过 SGS 80000 次抗疲劳运作测试，安心更舒心。  
Slide pass SGS 80000 anti-fatigue operation test, more comfortable.



高新技术企业证书  
Hi-tech Corporate Certificate



获英国皇冠 ISO9001 质量管理认证  
ISO9001 Quality Management System Certification



德国 TÜV 质量检测认证  
Quality Testing Certification



瑞士 SGS 质量检测认证  
Quality Testing Certification



## SALES NETWORK – 诺米全球营销网络

是中国的诺米，更是世界的诺米。依托全球化的服务体系，诺米长期为数百个国内外知名橱柜品牌、家居品牌提供五金解决方案，产品畅销亚洲、欧洲、北美洲等全球 70 多个国家和地区，占有国际中高端市场一席之地。

NUOMI is not only a Chinese brand, but also a global brand. With a globalized service system, NUOMI has long provided hardware solutions for hundreds of international kitchen cabinet and home furnishing brands. Its products are sold in more than 70 countries and regions around the world, including Asia, Europe, and North America, and have a leading position in the international high-end market.

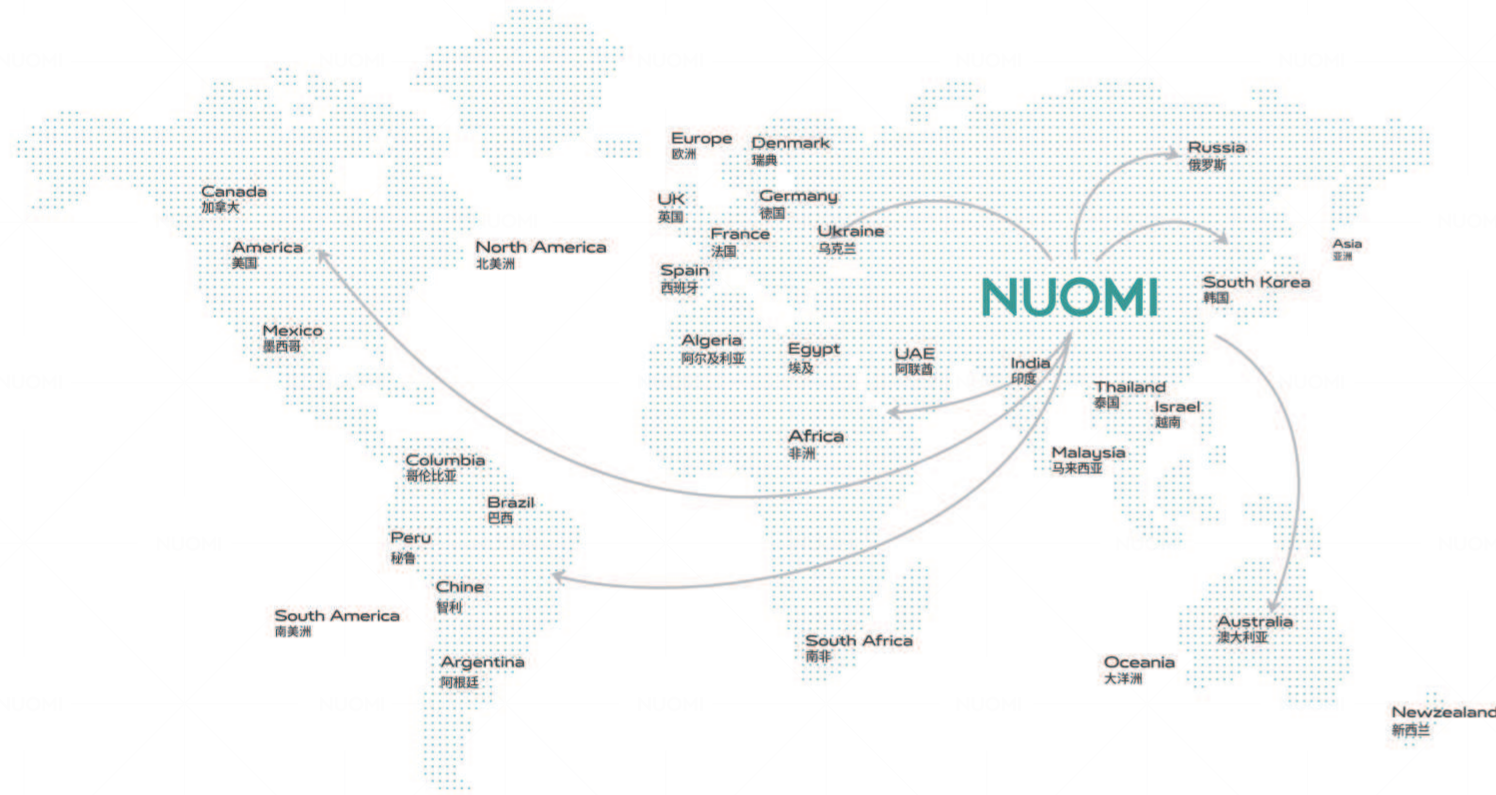

70+  
畅销国家和地区

200+  
销售服务网点

380+  
国内外家居品牌合作伙伴

在中国地区，诺米与一线上市家居品牌建立战略合作，拥有的 200 多个销售服务网点遍布全国城市圈。

In China, NUOMI has established strategic partnerships with first-tier listed home furnishing brands, and its sales network includes more than 200 distributors and agents covering cities across the country.

## SALES NETWORK – 全球网络布局

### ASIA 亚洲

- China 中国
- Malaysia 马来西亚
- Israel 以色列
- Vietnam 越南
- Thailand 泰国
- Saudi Arabia 沙特阿拉伯
- UAE 阿联酋
- Singapore 新加坡
- India 印度
- South Korea 韩国
- Mongolia 蒙古

### EUROPE 欧洲

- Austria 奥地利
- Ukraine 乌克兰
- Germany 德国
- Denmark 瑞典
- France 法国
- Denmark 丹麦
- Italy 意大利
- Finland 芬兰
- Spain 西班牙
- Norway 挪威
- UK 英国
- Greece 希腊
- Russia 俄罗斯
- Poland 波兰
- Portugal 奥地利

### AFRICA 非洲

- South Africa 南非
- Algeria 阿尔及利亚
- Egypt 埃及

### NORTH AMERICA 北美洲

- Mexico 墨西哥
- America 美国
- Canada 加拿大

### SOUTH AMERICA 南美洲

- Columbia 哥伦比亚
- Peru 秘鲁
- Brazil 巴西
- Chile 智利
- Argentina 阿根廷

### OCEANIA 大洋洲

- New Zealand 新西兰
- Australia 澳大利亚

DRAWER BOX 骑马抽系统

-  **分隔系统，科学规划收纳空间，让抽屉告别杂乱无章。**  
Separator system, scientifically plan the storage space, and let the drawers say goodbye to chaos.
-  **快装式卡扣结构，高效安装，拆卸方便。**  
Efficient installation, convenient to assemble and disassemble.
-  **隐藏式多维调节结构，确保抽屉安装精确稳定。**  
Concealed adjustment structure, make sure installation precise and stable.
-  **极佳的横向稳定性，滑动顺畅，带来自然、舒适的操作体验。**  
Excellent lateral stability and smooth sliding for a natural and comfortable operating experience.

HINGE 铰链系统

-  **德国精湛工艺，专业生产水平。**  
German exquisite craft, professional production level.
-  **专业检测，纳米钛金铰链通过 SGS168 小时盐雾测试标准，超强耐腐蚀性能。**  
Professional testing, nano titanium hinge passes the SGS168-hour salt spray test standard, super corrosion resistance.
-  **通过欧标 50000 次开合测试，品质认证，使用寿命长。**  
Pass the European standard 50,000 opening and closing tests, quality certification, long service life.

SLIDE 滑轨系统

-  **稳固结构，受力均匀，超强承重，不下垂、不变形。**  
Stable structure, uniform force, super load bearing, no drooping, no deformation.
-  **电镀锌表面处理，抗锈能力出众。**  
Electro-galvanized surface treatment, outstanding rust resistance.
-  **阻尼缓冲，自动减速，轻柔静音。**  
Damping buffer, automatic deceleration, Soft mute.
-  **螺丝孔精准定位，保证滑轨系统的平稳运作。**  
Precise positioning of the screw holes ensures smooth operation of the rail system.
-  **实心钢珠，顺滑无声，打造无噪音家居环境。**  
Solid steel ball, smooth and silent, creating a noise-free home environment.

骑马抽系统  
**DRAWER BOX**  
P.017

铰链系统  
**HINGE**  
P.087

滑轨系统  
**SLIDE**  
P.141

上翻门系统  
**TILT-UP LIFT**  
P.169

反弹器  
**REBOUND OPEN**  
P.173



# DRAWER BOX

骑马抽系统





# SIMPLE SERIES

## 简意系列

In the process of simplifying the complex, it gives people a sense of art in life but beyond the object. The dialogue between nature and art takes place slowly, and the residents' love and attachment to life are reflected in the space. The simplicity of nature is traced and narrated by artistic brushstrokes, amplifying the aesthetic experience, and finally achieving a reassuring ideal home with a temperament of suitable shades.

在化繁为简的过程中，予人生活其中而又超然物外的艺术感受。自然与艺术的对话慢慢发生，居者对生活的热爱与眷恋体现在空间之中。自然的质朴被艺术的笔触描摹、铺叙，将美学的体验放大，最终以浓淡相宜的气质，实现了令人心安的理想归处。



# SIMPLE GLASS LIGHTING HIGHTEN DRAWER BOX

简意玻璃灯光骑马抽  
— 美学之作



简意·极简的意大利风格

光与形的艺术都藏在透明哲学里

*The art of light and shape is hidden in the philosophy of transparency.*

NUOMI

DRAWER BOX

02



# AESTHETICS

美学之作

当“光”被引入  
即成为了自然赋予空间的灵魂

逐光溯影，极简与光影共舞  
用细微之处的跳跃点缀  
在和谐的色调中构筑对比之感  
成就一种更立体的姿态

When "light" is introduced  
That is to say, it becomes the soul endowed by  
nature to the space

Chasing light and shadow, minimalism and light  
and shadow dance together  
Embellished with subtle jumps  
Build a sense of contrast in harmonious tones  
Achieve a more three-dimensional posture



随柜门开闭感应亮熄

4000K / 6000 双色温可选

显指 RA ≥ 90

还原自然本色，温和不刺眼

4000K / 6000 dual color temperature optional  
Significant RA≥90  
Restore the natural color, mild and not dazzling



## 8MM ULTRA-THIN ULTRA-WHITE TEMPERED GLASS SIDE

8mm 超薄超白钢化玻璃侧板

玻璃洛氏硬度高达 65，轻松抵御日常用具刮蹭，颠覆传统封闭视觉体验，带来全景式通透视野。  
磁吸自动感应，见光不见灯，渲染高定美感。50000 次磁吸感应开合测试，依然灵敏如初。

The Rockwell hardness of glass is as high as 65, which can easily resist scratches from daily utensils, subvert the traditional closed visual experience, and bring a panoramic and transparent view. Automatic induction of magnetic attraction, see the light but not the light, rendering high-definition beauty. 50,000 magnetic induction opening and closing tests, still sensitive as ever.



# EFFICIENT INSTALLATION DESIGN

高效安装设计



## 免接线，随时方便更换电池

挂扣式快拆电池盒，1秒拆卸，一次换电稳用一年。

No wiring, easy to replace the battery at any time. The buckle-type quick-release battery box can be disassembled in 1 second, and it can be used for one year after one battery replacement.



## 超薄侧帮采用氟碳静电喷涂工艺

质感高级，触感细腻，抗褪色性能出色，保证抽屉防锈防腐、耐磨防刮，久用如新。

The ultra-thin side adopts fluorocarbon electrostatic spraying process. The texture is high-grade, the touch is delicate, and the anti-fading performance is excellent, which ensures that the drawer is rust-proof, anti-corrosion, wear-resistant and scratch-resistant, and looks like new for a long time.



## 卡扣式免工具快速安装

卡扣式快装前接码和固定件设计，安装更加快捷便利。

Snap-on tool-free quick installation. The buckle-type quick-installation front-mounting code and the design of the fixing parts make the installation quicker and more convenient.



## 三维调节把手，安装调试更便捷

可调节面板的高度和倾斜度，还能进行侧边调节，简单迅速即可精确调节缝隙，且无需工具。高度调节量0~+3mm，左右调节量±0.5mm，前后调节量±1.5mm。

Three-dimensional adjustment handle, more convenient installation and debugging. Adjustable height and tilt of the panels, as well as side adjustments, provide precise gap adjustments quickly and easily, without tools. The height adjustment is 0~+3mm, the left and right adjustment is ±0.5mm, and the front and rear adjustment is ±1.5mm.

# SYNCHRONOUS SLIDING LIGHT AND SMOOTH

## 迈赫隐藏式同步阻尼滑轨

运动同步，顺畅滑行，承重力强，坚实稳固，动态负重达30KG，保证抽屉在满负荷承载下使用，依然稳定顺滑。

Synchronous movement, smooth sliding, Strong load-bearing capacity, solid and stable, dynamic load up to 30KG, to ensure that the drawer is still stable and smooth when used under full load.



## GLASS LIGHTING DRAWER BOX

简意玻璃灯光中帮骑马抽

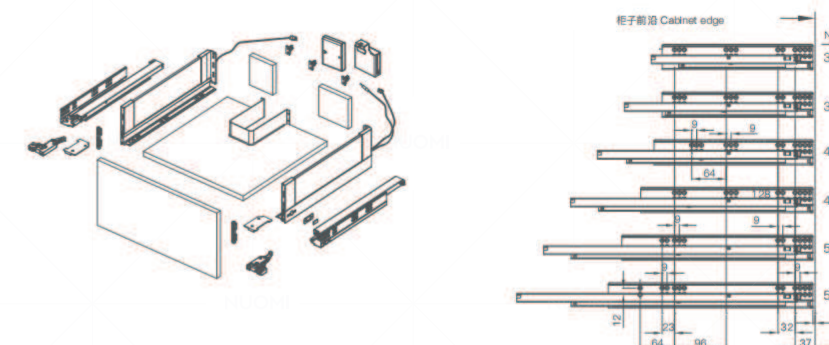

Product Name 产品名称	Item No. 型号	Nominal Length 标称长度	Physical Length 抽屉实际长度	Backboard Height 背板高度
简意玻璃灯光 中帮骑马抽 with lighting	香槟金 champagne golden	太郎灰 highclass grey		
	7082304	7082305	300	290
	7082354	7082355	350	340
	7082404	7082405	400	390
	7082454	7082455	450	440
	7082504	7082505	500	490
7082554	7082555	550	540	101

Instructions  
安装说明

KB 柜体宽度 / Cabinet width  
LW 柜体净宽 / Inner cabinet width  
NL 标称长度 / Nominal length

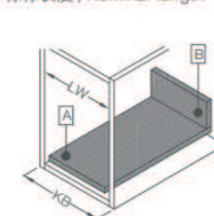

1. 箱体内部所需空间  
Space requirements in cabinet



2. 用于 16/18mm 密度板的  
裁切尺寸  
Cutting dim. for 16/18mm  
chipboard

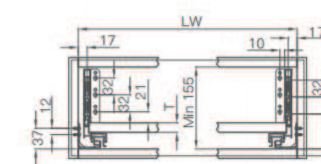

3. 箱体内部所需空间  
Space requirements in  
cabinet

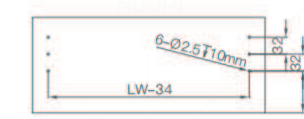

面板安装尺寸  
Back installation dimensions  
单位 unit:mm



champagne golden 香槟金

highclass grey 太郎灰



# GLASS LIGHTING DRAWER BOX

简意玻璃灯光高帮骑马抽

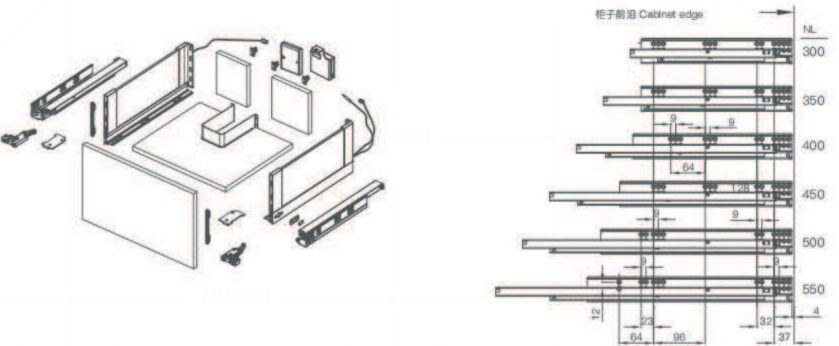

Product Name 产品名称	Item No. 型号	Nominal Length 标称长度	Physical Length 抽屉实际长度	Backboard Height 背板高度
简意玻璃灯光 高帮骑马抽 with lighting	香槟金 champagne golden	太郎灰 highclass grey		
	7083304	7083305	300	290
	7083354	7083355	350	340
	7083404	7083405	400	390
	7083454	7083455	450	440
	7083504	7083505	500	490
7083554	7083555	550	540	148

### Instructions 安装说明

KB 柜体宽度 / Cabinet width  
LW 柜体净宽 / Inner cabinet width  
NL 标称长度 / Nominal length

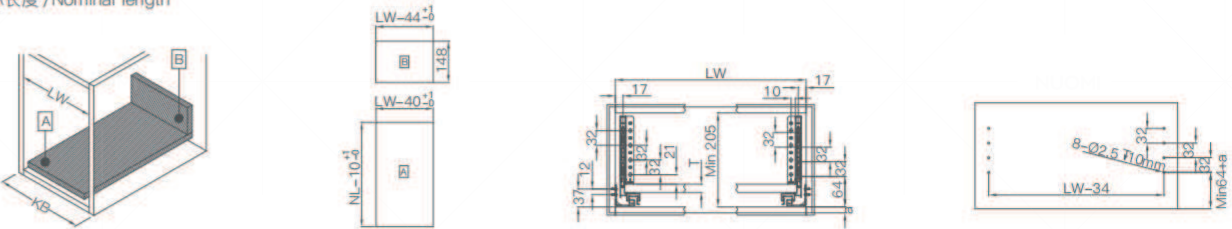

1. 箱体内部所需空间  
Space requirements in cabinet

2. 用于 16/18mm 密度板的  
裁切尺寸  
Cutting dim. for 16/18mm  
chipboard

3. 箱体内部所需空间  
Space requirements in cabinet

面板安装尺寸  
Back installation dimensions  
单位 unit:mm

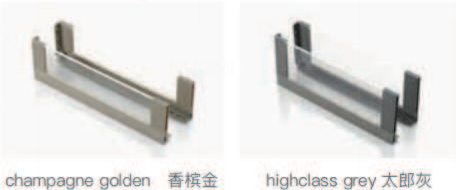

champagne golden 香槟金 highclass grey 太郎灰







## 12MM ULTRA-THIN

12mm 超薄侧帮

将极简做到极致，在方寸间实现更大能效  
侧帮较常规 18mm 抽屉薄 30%

*The thickness of the side panels is 30% lighter and thinner  
than conventional drawers*





## SAME COLOR

2色可选，全屋同色

以五金同色，回应高级的审美向往

Respond to the high-level aesthetic yearning  
with the same color of hardware



# EFFICIENT INSTALLATION DESIGN

高效安装设计



## 卡扣式快装

卡扣式快装前接码和固定件设计，使得门板和背板安装更加快捷便利。

Snap-on quick installation.  
Snap fit front connector and fastener design make the installation of door panel and back panel faster and more convenient.

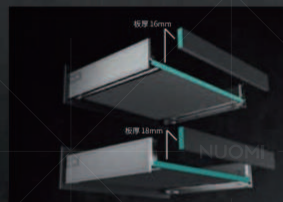

## 16mm 与 18mm 厚度底板背板通用

可通用 16mm 与 18mm 厚度的底板和背板，安装使用范围更广。

Universal for 16mm and 18mm thickness backboard and baseboard.



## 门板安装调节

门板可上下左右调节，简单进行缝隙调节，现实高精度安装。

Installation and adjustment of door panel.  
The door panel can be adjusted up, down, left and right. It is easy to adjust the gap, and it can be installed with high precision.



## 导轨快装联接

导轨快装联接设计，轻松安装。德国技术阻尼导轨，通过欧标 80000 次运动测试。

Quick Assembly with Slide  
Soft-close slide of German technology, pass through SGS80000 cycles test, easy and convenient to assemble.

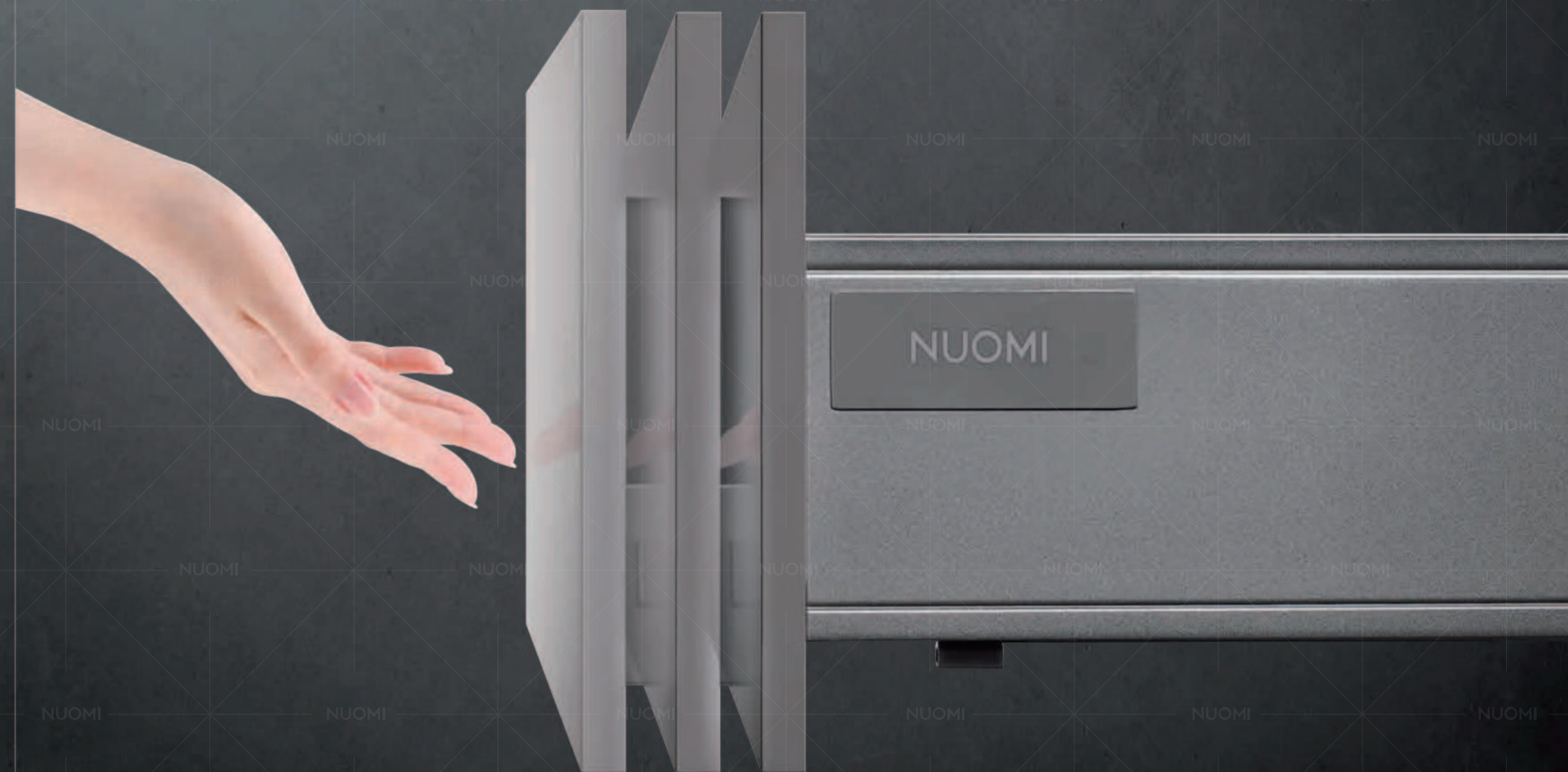

# SYNCHRONOUS SLIDING LIGHT AND SMOOTH

同步滑动 轻盈顺畅

推拉时滑动轻盈，静音无噪。在以人为出发点的设计理念中，遵循产品纯粹至美的风格，专注把每一套产品做到极致，成就无论是体验上还是美观上的高度满足。耐磨损塑料滚轮、导轨同步装置及轨道打造了轻盈顺畅的同步滑动，抽屉的开合特别安静、轻柔、稳定。

It slides lightly when pushing and pulling, and it is silent and no noise. In the human-based design concept, follow the product's pure and beautiful style, focus on making each set of products the ultimate, and achieve high satisfaction in both experience and beauty. Wear-resistant plastic rollers, guide rail synchronizing device and track create light and smooth synchronous sliding, and the opening and closing of the drawer is particularly quiet, soft and stable.



## SLIM DRAWER BOX

简意低帮骑马抽

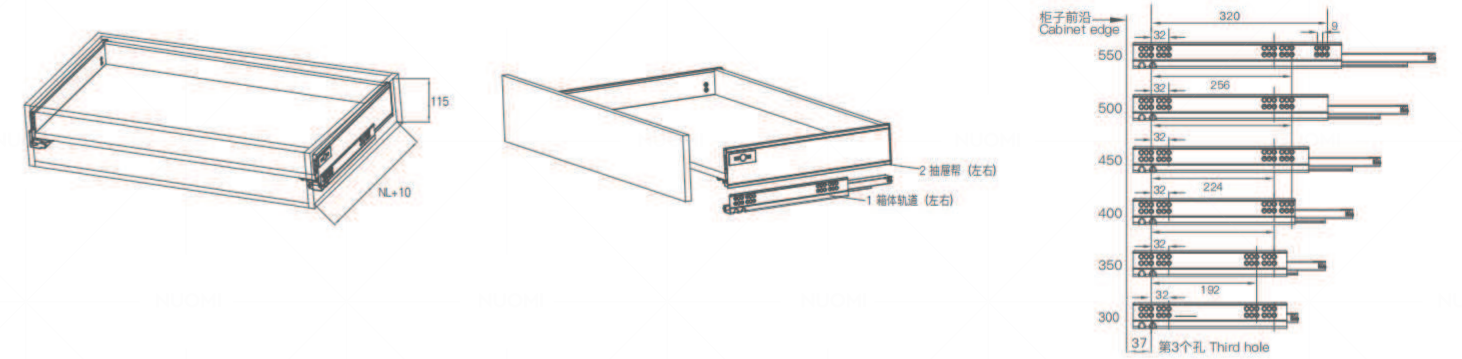

Item No. 型号	Nominal Length 标称长度	Physical Length 抽屉实际长度	Backboard Height 背板高度
香槟金 Champagne golden	太郎灰 Highclass grey		
7081301	7081302	300	290
7081351	7081352	350	340
7081401	7081402	400	390
7081451	7081452	450	440
7081501	7081502	500	490
7081551	7081552	550	540

Instructions  
安装说明

KB 柜体宽度 / Cabinet width  
LW 柜体净宽 / Inner cabinet width  
NL 标称长度 / Nominal length

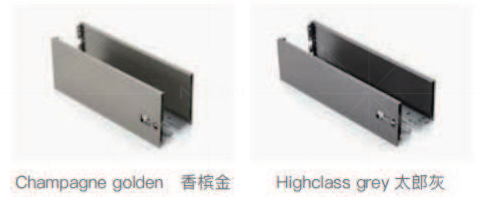
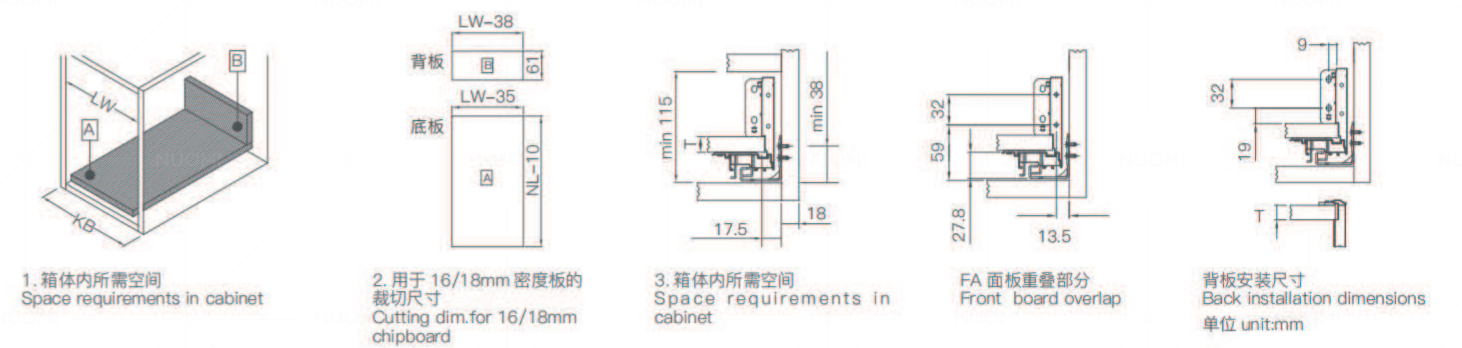

Champagne golden 香槟金 Highclass grey 太郎灰



## SLIM DRAWER BOX

简意中帮骑马抽

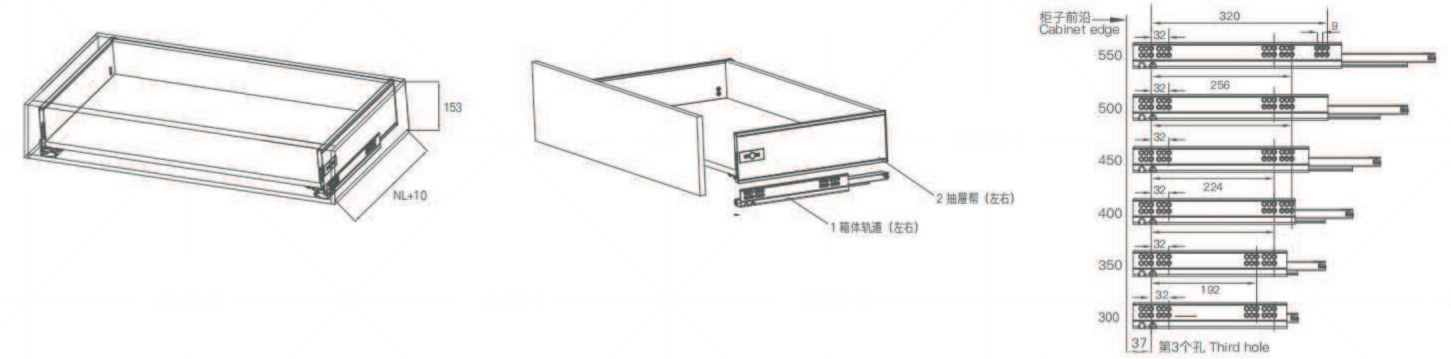

Item No. 型号	Nominal Length 标称长度	Physical Length 抽屉实际长度	Backboard Height 背板高度
香槟金 Champagne golden	太郎灰 Highclass grey		
7082301	7082302	300	290
7082351	7082352	350	340
7082401	7082402	400	390
7082451	7082452	450	440
7082501	7082502	500	490
7082551	7082552	550	540

Instructions  
安装说明

KB 柜体宽度 / Cabinet width  
LW 柜体净宽 / Inner cabinet width  
NL 标称长度 / Nominal length

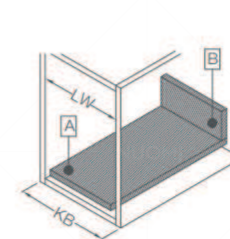

1. 箱体所需空间  
Space requirements in cabinet



2. 用于 16/18mm 密度板的  
裁切尺寸  
Cutting dim. for 16/18mm  
chipboard

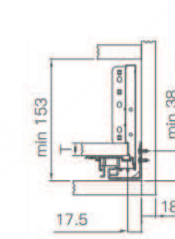

3. 箱体所需空间  
Space requirements in  
cabinet

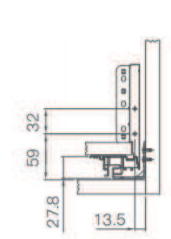

FA 面板重叠部分  
Front board overlap

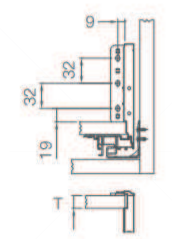

背板安装尺寸  
Back installation dimensions  
单位 unit:mm



Champagne golden 香槟金



Highclass grey 太郎灰



# SLIM DRAWER BOX

## 简意高帮骑马抽

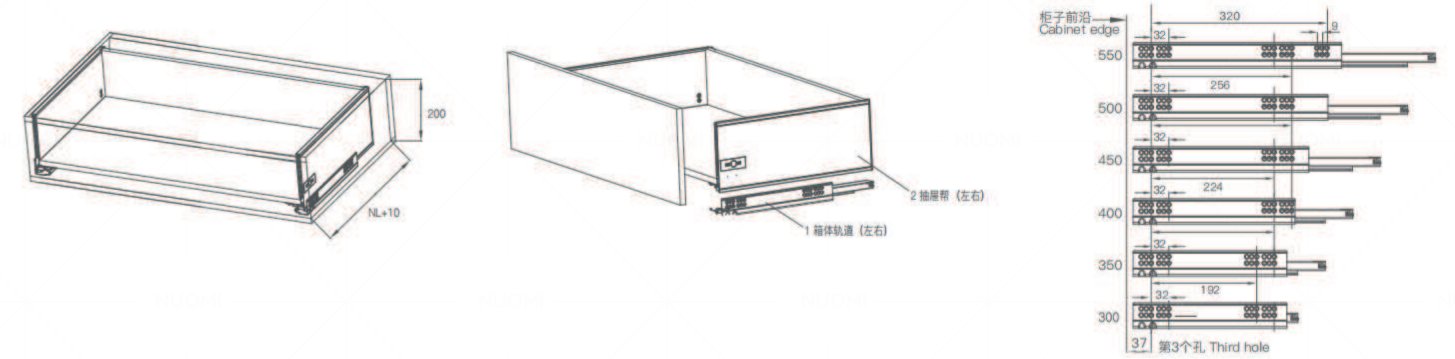

Item No. 型号	Nominal Length 标称长度	Physical Length 抽屉实际长度	Backboard Height 背板高度
香槟金 Champagne golden	太郎灰 Highclass grey		
7083301	7083302	300	290
7083351	7083352	350	340
7083401	7083402	400	390
7083451	7083452	450	440
7083501	7083502	500	490
7083551	7083552	550	540

### Instructions 安装说明

KB 柜体宽度 / Cabinet width  
LW 柜体净宽 / Inner cabinet width  
NL 标称长度 / Nominal length

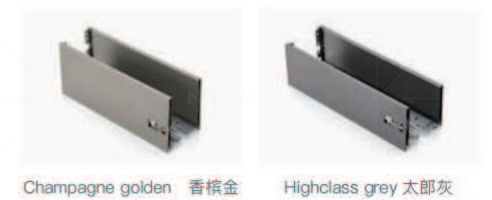
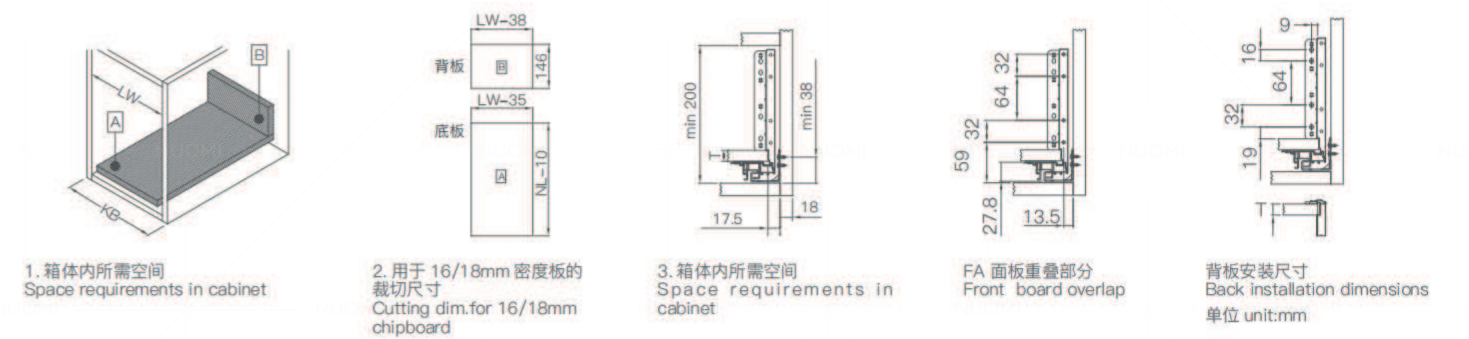

Champagne golden 香槟金 Highclass grey 太郎灰





## CABINET STORAGE SOLUTIONS

柜内收纳，整体解决方案

配套同色柜内收纳，提供整体解决方案

Match cabinet storage solutions in same color surface treatment, maintain the uniformity.





## SIMPLE SEPARATOR OF DRAWER BOX



### SIMPLE SEPARATOR OF DRAWER BOX

Functionally, it satisfies a variety of storage structures and establishes a sense of order and hierarchy. In addition to regularizing the space, the sense of life experience and ritual are enhanced.

### 简意骑马抽分隔

功能上满足多种收纳结构，建立秩序感与层次性。使空间规整之余，生活体验感和仪式感被提升。



# SIMPLE SEPARATOR OF DRAWER BOX

简意低帮骑马抽刀叉分隔

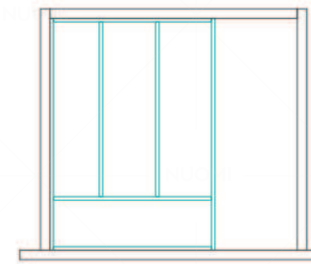

适用 400mm-600mm 柜宽

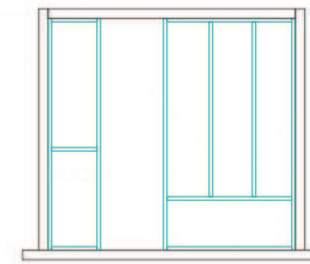

适用 600mm-750mm 柜宽

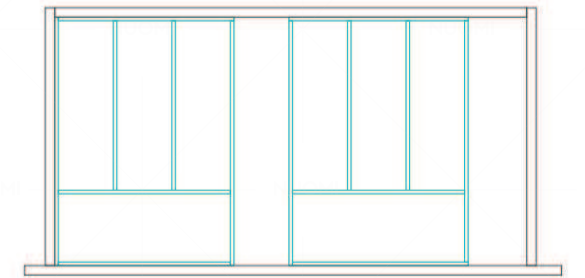

适用 750mm-1000mm 柜宽

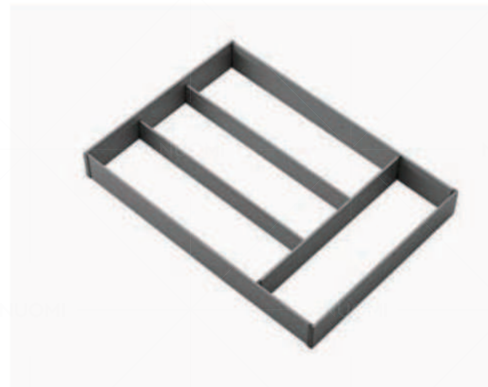

Highclass grey 太郎灰



Champagne golden 香槟金

Item No. 型号		Applicative Width 适用柜宽	Applicative Depth 适用柜深	Surface Treatment 表面处理
香槟金 Champagne golden	太郎灰 Highclass grey			
7021451	7022451	400-600mm		
7021452	7022452	600-750mm	450mm	
7021453	7022453	750-1000mm		
7021501	7022501	400-600mm		氟碳喷涂 fluorocarbon coating
7021502	7022502	600-750mm	500mm	
7021503	7022503	750-1000mm		





# SIMPLE SEPARATOR OF DRAWER BOX

简意高帮骑马抽分隔

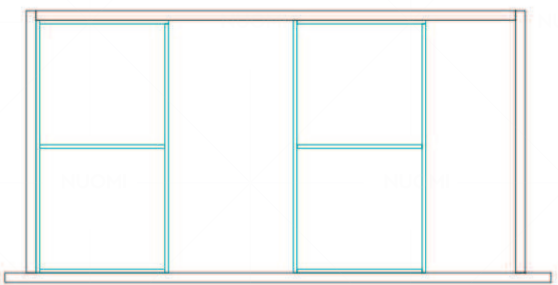

Highclass grey 太郎灰



Champagne golden 香槟金

Description 产品名称	Item No. 型号	Specification 规格
骑马抽高帮两分隔 Two-section separator high drawer box	7021003	420x220x110mm
骑马抽高帮三分隔 Three-section separator for high drawer box	7021004	420x220x110mm



## SIMPLE FRONT ACCESSORIES FOR DRAWER BOX

简意内低抽前板

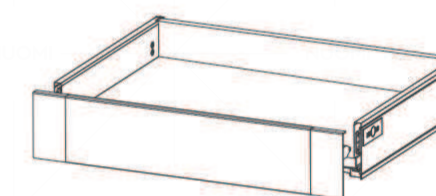
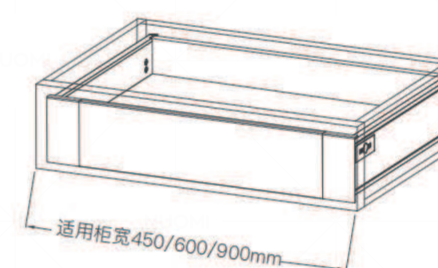

Item No. 型号		Applicative Width 适用柜宽
香槟金 Champagne golden	大郎灰 Highclass grey	
7087451	7087452	450mm
7087601	7087602	600mm
7087901	7087902	900mm





## SIMPLE FRONT ACCESSORIES FOR DRAWER BOX

简意内高抽前板

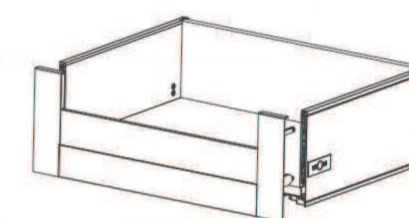
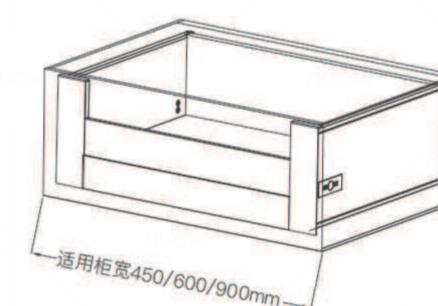

Item No.  
型号

Applicative Width  
适用柜宽

香槟金  
Champagne golden

大郎灰  
Highclass grey

7089451

7089452

450mm

7089601

7089602

600mm

7089901

7089902

900mm



SIMPLE BACKPLANE ACCESSORIES  
FOR DRAWER BOX

简意金属背板

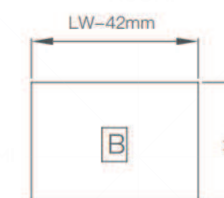
LW 柜体净宽 / Inner cabinet width  
背板减尺: 42mm

Highclass grey 太郎灰



Champagne golden 香槟金



Highclass grey 太郎灰

Description 产品名称	Item No. 型号	Length x Height 长 x 高	Applicative Drawer Box 适用骑马抽
	香槟金 Champagne golden	太郎灰 Highclass grey	
	7080311	7080312	低帮骑马抽 Drawer box
	7080321	7080322	中帮骑马抽 Mid-height drawer box
	7080331	7080332	高帮骑马抽 High drawer box
	7080311A	7080312B	低帮骑马抽 Drawer box
简意金属背板 for Drawer Box with glass	7080321A	7080322B	中帮骑马抽 Mid-height drawer box
	7080331A	7080332B	高帮骑马抽 High drawer box





## U-SHAPED ACCESSORY FOR SINK DRAIN

U型抽屉槽

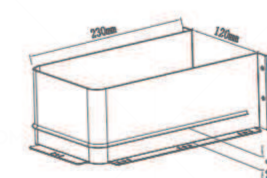

底板开孔尺寸 (mm)

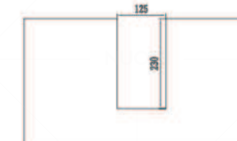

铝合金

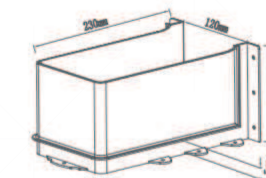

底板开孔尺寸 (mm)

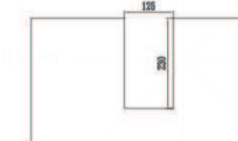

ABS

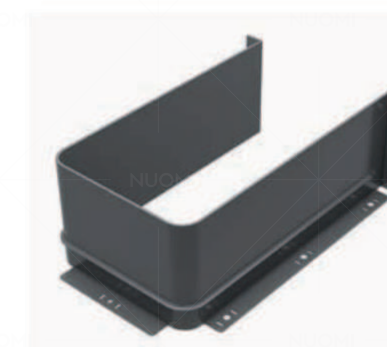

Item No. 型号	Color 颜色	Specification 规格	Material 材质
7080917	太郎灰 highclass grey	244x155x86.4mm	铝合金 aluminum alloy
7080918	香槟金 champagne golden	244x155x86.4mm	铝合金 aluminum alloy
7080919	灰色 grey	245x150x118mm	ABS



## ACCESSORY FOR DRAWER BOX OF 16MM BOARD

16mm 板配件

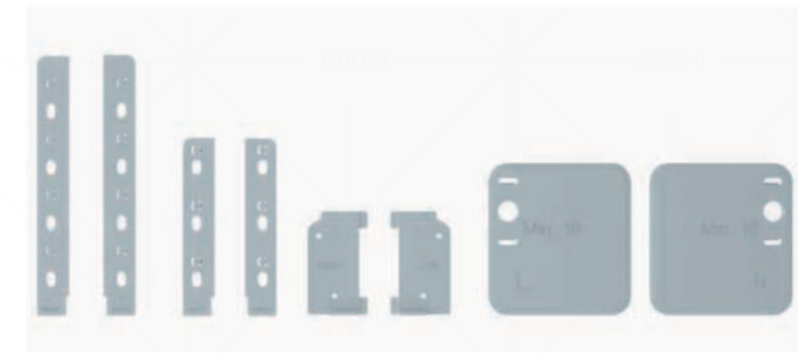

Description 产品名称	Item No. 型号	Applicative Drawer Box 适用骑马抽
简意玻璃灯光中帮骑马抽 16mm 板配件	accessory for drawer box of 16mm board 7080915	中帮骑马抽 mid-height drawer box
简意玻璃灯光高帮骑马抽 16mm 板配件	accessory for drawer box of 16mm board 7080916	高帮骑马抽 high drawer box



Description 产品名称	Item No. 型号	Applicative Drawer Box 适用骑马抽
简意低抽 16mm 板配件	accessory for drawer box of 16mm board 7080911	低帮骑马抽 mid-height drawer box
简意中抽 16mm 板配件	accessory for drawer box of 16mm board 7080912	中帮骑马抽 mid-height drawer box
简意高抽 16mm 板配件	accessory for drawer box of 16mm board 7080913	高帮骑马抽 high drawer box







# OYA SERIES

欧雅系列

High-quality drawers are characterized by efficiency, convenience and stability. The smooth sliding opening and closing makes a delicate balance between elaborate and life. The intimately designed separation system realizes the possibility of flexible use and provides a long-term comfort experience for life. NUOMI drawer box system, two colors optional, compatible with a variety of design styles, so that the kitchen life more than one side.

高品质的抽屉具有高效、便捷、稳定三个特点。顺畅滑动的开合，在精工与生活之间起到巧妙的平衡，贴心设计的分隔系统实现了灵活使用的可能性，为生活提供长久的舒适体验。诺米骑马抽系统，两色可选，兼容多种设计风格，让厨房生活不止一面。





### 品质与美学的交融

在功能和美学中寻求一种平衡，满足使用功能的前提下，将极致的美感表达出来，更能体验家居空间的完美品质。

### DEDUCTIVE GREY BEAUTY

The minimalist and trendy grey is more meticulous in the elegant tone, adding a superb and extraordinary style to your cabinet drawers.



# GRAY AND WHITE, COLOR SELECTION

灰与白，经典的色调选择

陨石灰、丝光白，高端家居空间的选择，永恒的经典颜色；高端、和谐，更能突现家居生活的质感。  
Aerolite grey, brilliant white, the choice of high-end home space, eternal classic color; high-end, harmonious, can highlight the texture of home life.







# OYA DRAWER BOX

欧雅骑马抽

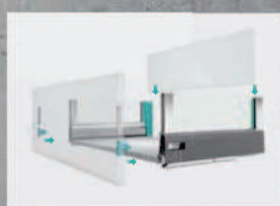

## 卡扣式快装

卡扣式快装前接码和固定件设计，使得门板和背板安装更加快捷便利。

Snap-on quick installation  
Snap fit front connector and fastener design make the installation of door panel and back panel faster and more convenient.

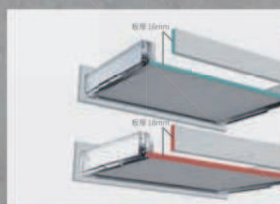

## 16mm 与 18mm 厚度底板背板通用

可通用 16mm 与 18mm 厚度的底板和背板，安装使用范围更广。

Universal for 16mm and 18mm thickness backboard and baseboard.



## 门板安装调节

门板可上下左右调节，简单进行缝隙调节，现实高精度安装。

Installation and adjustment of door panel  
The door panel can be adjusted up, down, left and right. It is easy to adjust the gap, and it can be installed with high precision.



## 垂直安装调节（玻璃加高骑马抽）

垂直安装调节系统，轻松实现完美安装。

Vertical installation and adjustment (Glass-heighten Drawer Box)  
Vertical installation of the adjustment system, easy to achieve the perfect installation.



## 导轨快装联接

导轨快装联接设计，轻松安装。德国技术阻尼导轨，通过欧标 80000 次运动测试。

Quick Assembly with Slide  
Soft-close slide of German technology, pass through SGS80000 cycles test, easy and convenient to assemble.



## 阻尼缓冲，顺畅无声

极佳的横向稳定性，承重力强不变形，出色的滑动性能，每一次闭合皆轻柔无声。

Damping Buffer, Smooth And Silent  
Excellent lateral stability, strong bearing capacity, no deformation, excellent sliding performance, soft and silent every time.



## OYA DRAWER BOX

欧雅低帮骑马抽

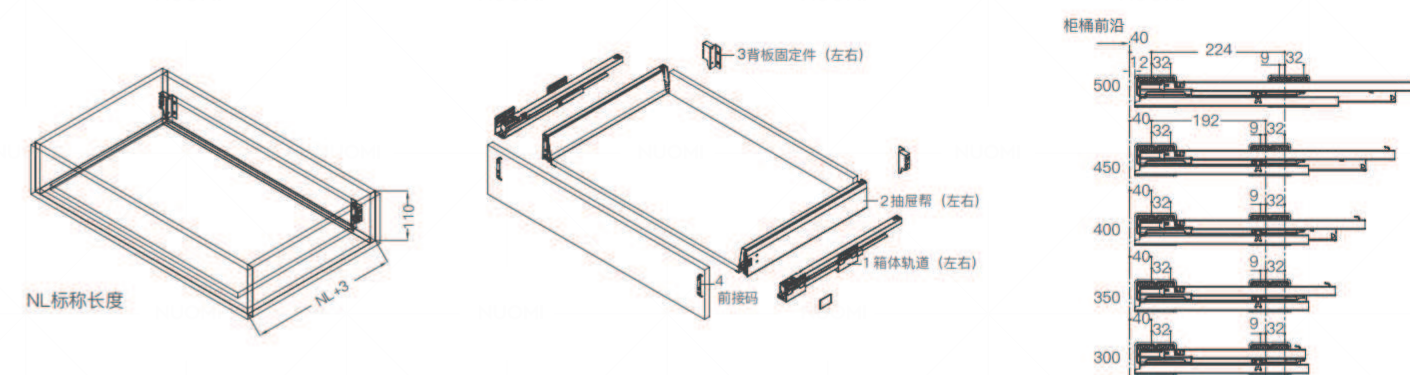

Item No. 型号		Nominal Length 标称长度	Physical Length 抽屉实际长度	Backboard Height 背板高度
陨石灰 Aerolite Grey	丝光白 Brilliant White			
7071301	7071302	300mm	290mm	84mm
7071351	7071352	350mm	340mm	84mm
7071401	7071402	400mm	390mm	84mm
7071451	7071452	450mm	440mm	84mm
7071501	7071502	500mm	490mm	84mm

Instructions  
安装说明

KB 柜体宽度 / Cabinet width  
LW 柜体净宽 / Inner cabinet width  
NL 标称长度 / Nominal length

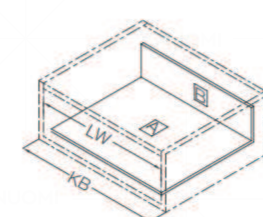

1. 箱体内所需空间  
Space requirements in cabinet

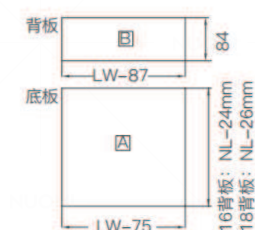

2. 用于 16/18mm 密度板的  
裁切尺寸  
Cutting dim. for 16/18mm  
chipboard

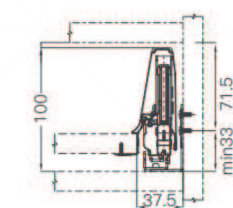

3. 箱体内所需空间  
Space requirements in  
cabinet

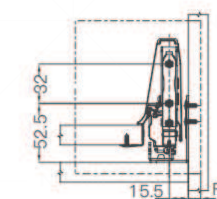

FA 面板重叠部分  
Front board overlap

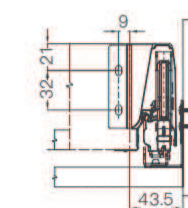

背板安装尺寸  
Back installation dimensions  
单位 unit:mm



## OYA DRAWER BOX

优雅玻璃加高骑马抽

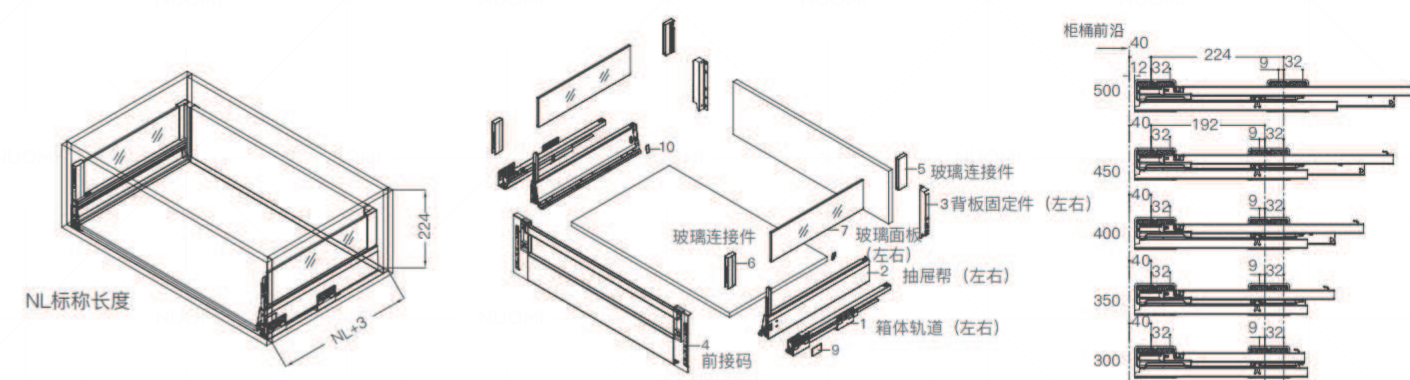

Item No. 型号		Nominal Length 标称长度	Physical Length 抽屉实际长度	Backboard Height 背板高度
陨石灰 Aerolite Grey	丝光白 Brilliant White			
7072301	7072302	300mm	290mm	199mm
7072351	7072352	350mm	340mm	199mm
7072401	7072402	400mm	390mm	199mm
7072451	7072452	450mm	440mm	199mm
7072501	7072502	500mm	490mm	199mm

Instructions  
安装说明

KB 柜体宽度 / Cabinet width  
LW 柜体净宽 / Inner cabinet width  
NL 标称长度 / Nominal length

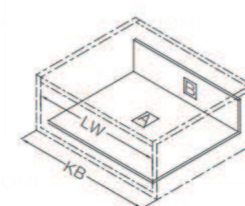

1. 箱体所需空间  
Space requirements in cabinet

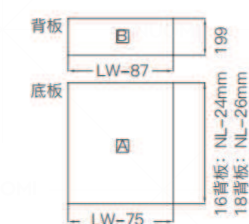

2. 用于16/18mm密度板的  
裁切尺寸  
Cutting dim. for 16/18mm  
chipboard

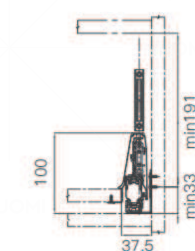

3. 箱体所需空间  
Space requirements in  
cabinet

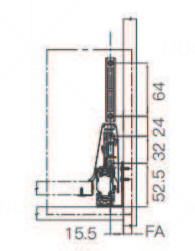

FA 面板重叠部分  
Front board overlap

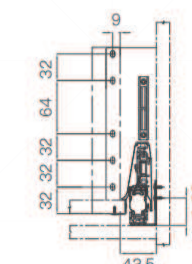

背板安装尺寸  
Back installation dimensions  
单位 unit:mm



## OYA DRAWER BOX

优雅方杆加高骑马抽

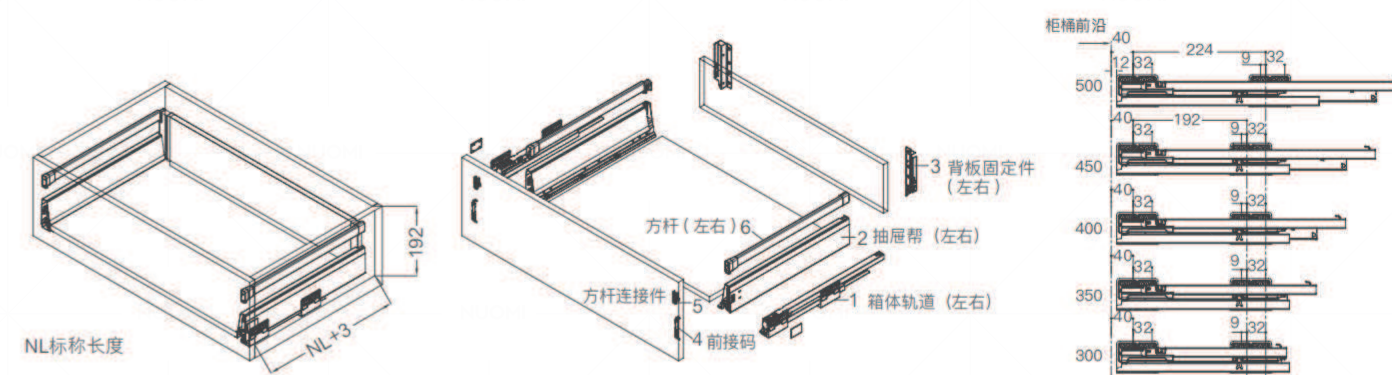

NL标称长度

Description 产品名称	Item No. 型号	Nominal Length 标称长度	Physical Length 抽屉实际长度	Backboard Height 背板高度
方杆加高骑马抽 Drawer Box with Square Rod	陨石灰 Aerolite Grey	丝光白 Brilliant White		
	7073301	7073302	300mm	290mm
	7073351	7073352	350mm	340mm
	7073401	7073402	400mm	390mm
	7073451	7073452	450mm	440mm
方杆中高骑马抽 Drawer Box with Square Rod	7073501	7073502	500mm	490mm
	7074301	7074302	300mm	290mm
	7074351	7074352	350mm	340mm
	7074401	7074402	400mm	390mm
	7074451	7074452	450mm	440mm
7074501	7074502	500mm	490mm	155mm

Instructions  
安装说明

KB 柜体宽度 / Cabinet width  
LW 柜体净宽 / Inner cabinet width  
NL 标称长度 / Nominal length

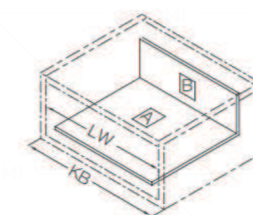

1. 箱体内部所需空间  
Space requirements in cabinet

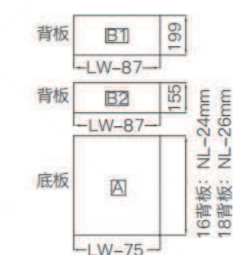

2. 用于 16/18mm 密度板的  
裁切尺寸  
Cutting dim.for 16/18mm  
chipboard

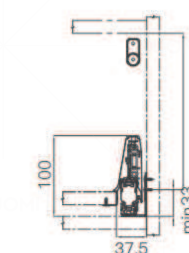

3. 箱体内部所需空间  
Space requirements in  
cabinet

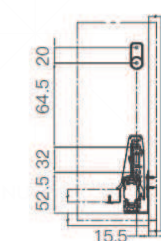

FA 面板重叠部分  
Front board overlap

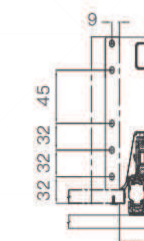

背板安装尺寸  
Back installation dimensions  
单位 unit:mm





## OYA SEPARATOR OF DRAWER BOX

欧雅骑马抽分隔

RESHAPE THE DRAWER SPACE  
ENJOY THE QUALITY OF LIFE  
重塑抽屉空间，享受品质生活

The partition system is perfectly connected to the glass side panels to create a sophisticated, upscale look. The design of the movable partition is a combination of humanity and art. It reduces the complexity of the visual, makes the space return to a neat and tidy, and provides an unobstructed view of the items, giving people a beautiful visual enjoyment.

分隔系统与加高玻璃侧板完美衔接，形成精致高档的外观。可移动分隔件的设计是人性化与艺术的结合，它减少了视觉的纷杂，让空间回归整洁，收纳物品时一览无余，给人们带来美的视觉享受。



## OYA SEPARATOR OF DRAWER BOX

欧雅骑马抽刀叉分隔

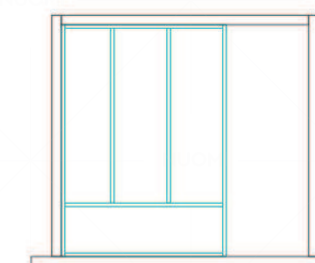

适用 400mm-600mm 柜宽

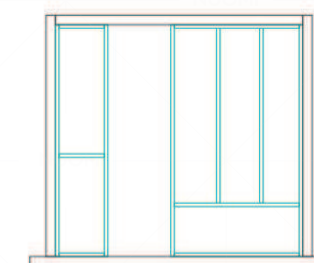

适用 600mm-750mm 柜宽

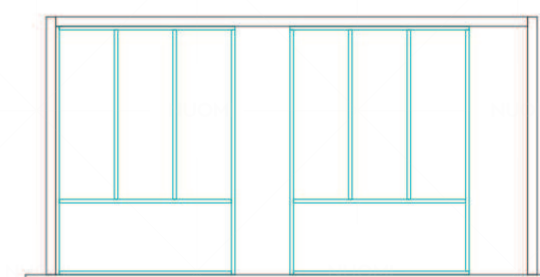

适用 750mm-1000mm 柜宽

## SPACE FREE

人性化的分隔系统，巧妙的将空间划分，形成多个独立丰富的收纳区域，方便刀叉等小餐具的储存，让抽屉告别杂乱无章。  
The humanized separation system subtly divides the space to form a plurality of independent and rich storage areas, which facilitates the storage of small cutlery such as cutlery and forks, and makes the drawers say goodbye to chaos.

Item No. 型号	Applicative Width 适用柜宽	Applicative Depth 适用柜深	Surface Treatment 表面处理
7020451	400-600mm	450mm	拉丝铁灰色
7020452	600-750mm		
7020453	750-1000mm		
7020501	400-600mm	500mm	
7020502	600-750mm		
7020503	750-1000mm		



# OYA SEPARATOR OF DRAWER BOX

欧雅玻璃加高抽屉分隔

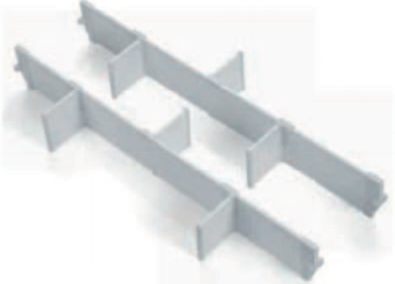
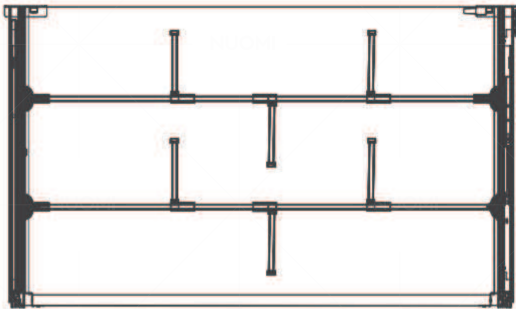

Brilliant White 丝光白



Aerolite Grey 陨石灰

Description 产品名称	Item No. 型号	Applicative Width 适用柜宽
玻璃加高抽屉分隔 (丝光白) Separator for Drawer Box with Glass (Brilliant White)	7016601	600mm
	7016901	900mm
玻璃加高抽屉分隔 (陨石灰) Separator for Drawer Box with Glass (Aerolite Grey)	7016603	600mm
	7016903	900mm





## OYA SEPARATOR OF DRAWER BOX

欧雅方杆加高抽屉分隔

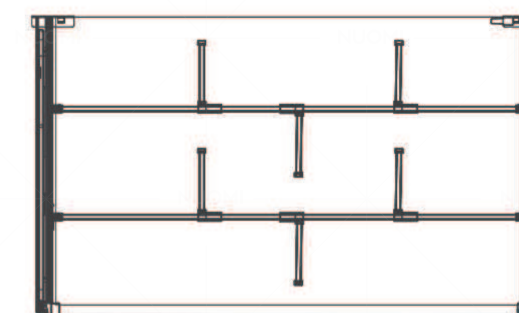

Brilliant White 丝光白

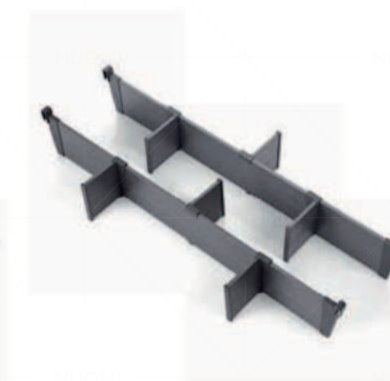

Aerolite Grey 陨石灰

产品名称 Description	型号 Item No.	适用柜宽 Applicative Width
方杆加高抽屉分隔 (丝光白) Separator for Drawer Box with Square Rod (Brilliant white)	7017601	600mm
	7017901	900mm
方杆加高抽屉分隔 (陨石灰) Separator for Drawer Box with Square Rod (Aerolite Grey)	7017603	600mm
	7017903	900mm



## OYA FRONT ACCESSORIES FOR DRAWER BOX

欧雅内低抽前板

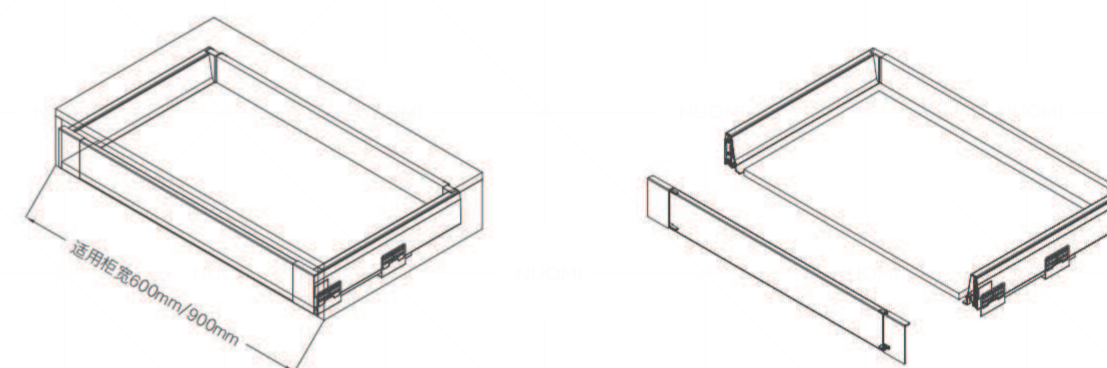

产品名称 Description	型号 Item No.	适用柜宽 Applicative Width
内低抽前板（丝光白） Front Accessories for Drawer Box (Brilliant white)	7018601	600mm
	7018901	900mm
内低抽前板（陨石灰） Front Accessories for Drawer Box (Aerolite Grey)	7018603	600mm
	7018903	900mm



## OYA FRONT ACCESSORIES FOR DRAWER BOX

欧雅玻璃加高内抽前板

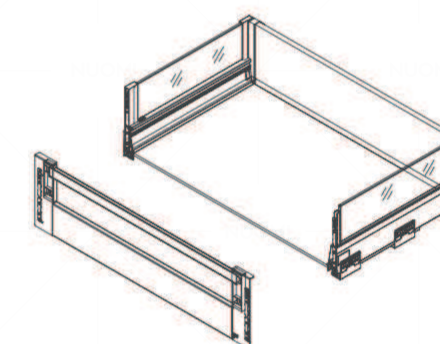
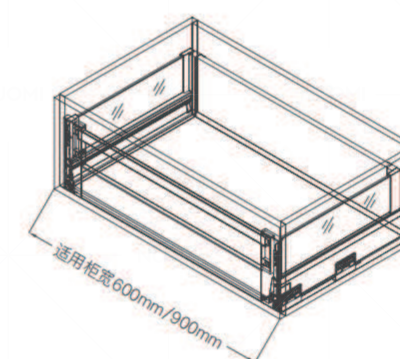

产品名称 Description	型号 Item No.	适用柜宽 Applicative Width
玻璃加高内抽前板 (丝光白) Front Accessories for Drawer Box with glass (Brilliant white)	7019601	600mm
	7019901	900mm
玻璃加高内抽前板 (陨石灰) Front Accessories for Drawer Box with glass (Aerolite Grey)	7019603	600mm
	7019903	900mm



# HINGE

铰链系统





# BULLET SERIES

子弹头系列



The overall shape is smooth and natural, interpreting the essence of minimalism. Seeking a balance of life essence between dynamic and static is also a combination of rich functional needs. The functionality is fully upgraded, and everything hidden behind it is the persistent pursuit of details and quality.

整体造型流畅、自然，诠释着极简的真谛。在动、静之间寻求一种生活本质的平衡，亦是富机能需求的结合。功能性全面升级，背后隐藏的无一不是对于细节、品质的执着追求。



# Bullet 子弹头



## STREAMLINE

BULLET 子弹头 | 一字底座铰链

<b>“复兴号” 高铁</b> 完全自主 世界先进 从零起步 到突破技术封锁	"Fuxing" high-speed rail Fully autonomous world advanced From scratch to break through technology blockade
一次超越 再一次超越 进取 颠覆 创新 这就是时代的样子	surpass once surpass again and again Enterprising Subversive Innovation this is what the times look like
致敬时代向上的力量 为高定家居而生	Pay tribute to the upward force of the times Born for high-end home furnishing

- 极简一体 全能均衡**
- 极简美学三色定制**  
Minimalist aesthetic three-color customization
- 15° 小角度缓冲**  
15° small angle buffer
- 16-25mm 多门板应用**  
16-25mm multi-door application
- 隐藏式一字底座**  
Hidden flat base
- 一体式结构安装便捷**  
One-piece structure is easy to install
- 远超行业测试标准**  
Far exceeds industry testing standards

## ADVANCED CUSTOM

高定首选，流线型外观极简美学

流线型外观设计源于复兴号，是技术、功能和美学的完美融合。

延续全屋五金同色理念，波尔多红、香槟金、太郎灰三色定制，极简高端满足塔尖人群的个性化定制需求。

The streamlined appearance design is derived from Fuxing, A perfect fusion of technology, function and aesthetics.

Continuing the concept of the whole house hardware with the same color, Bordeaux red, champagne gold, highclass grey three-color customization, The minimalist and high-end design meets the personalized customization needs of the spire crowd.



# TEST STANDARD

远超行业测试标准

使用寿命长达 20 年，长久守护高品质生活  
The service life is up to 20 years, long-term protection of high-quality life

# 20 YEARS

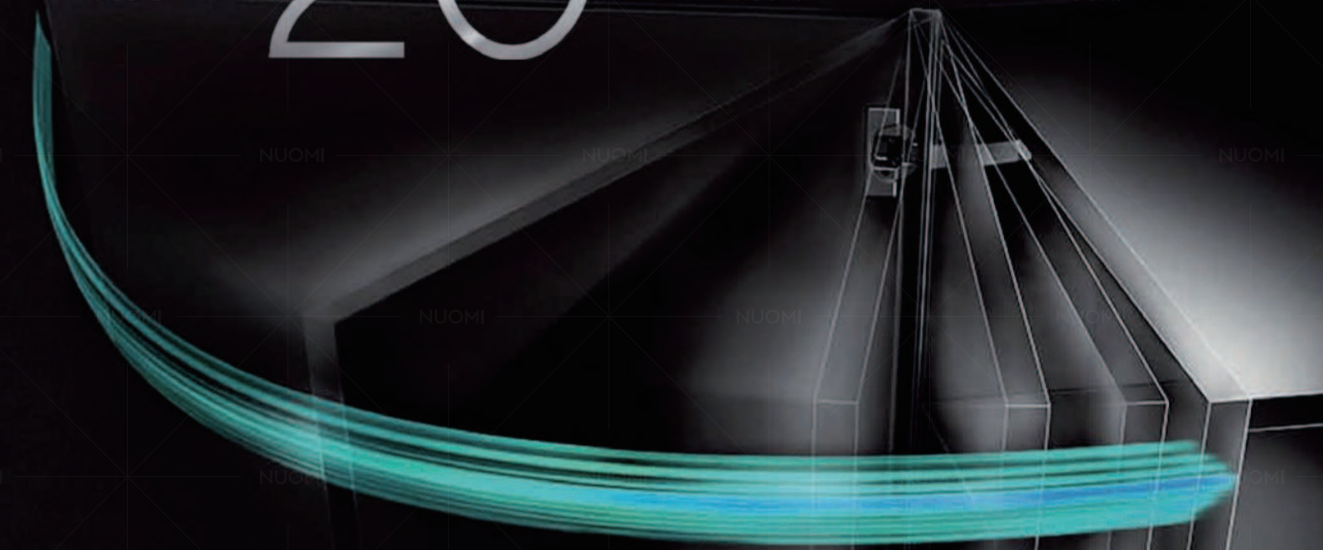

## ADVANCED CUSTOM

高定首选，致敬高阶审美

三色定制，与全屋五金同色  
Three-color customization, keep uniform color for whole house fittings.

### 极简美学

颠覆传统外型及设计理念，功能与艺术兼具

Minimalist Aesthetics  
Subvert the traditional appearance and design concept, combine function and art.



Champagne golden 香槟金

Highclass grey 太郎灰

Bordeaux red 波尔多红

### 小角度里的“大作用” 开启 15° 就是缓冲

15°小角度缓冲，关门轻柔防夹手。  
当角度 > 45°，可多段悬停，轻松取物。

0-15° 缓冲闭合 | 45°-100° 任意悬停  
0-15° buffer closure | 45°-100° hovering freely

### 大开孔直径承重更强 多门板适用

35mm 开槽直径加大受力面积，  
承重更强更结实，门板适用范围更广。

35mm 铰杯直径 | 11.5mm 铰杯深度 | 16-25mm 侧板厚度  
35mm hinge cup diameter | 11.5mm hinge cup depth | 16-25mm side panel thickness



WINGLESS HINGE  
一字底座铰链



Full Overlay  
直臂

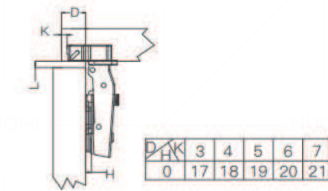

Hole Size  
钻孔尺寸

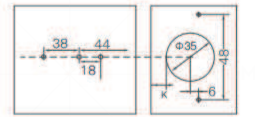

Half Overlay  
中弯

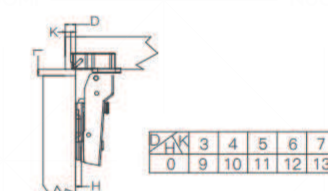

Hole Size  
钻孔尺寸

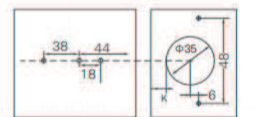

Inserted  
大弯

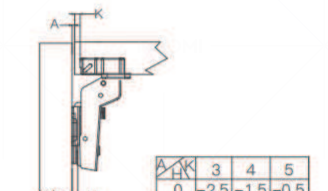

Hole Size  
钻孔尺寸

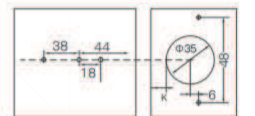

一字底座

精致的隐藏艺术

铰链底座 + 螺丝孔全隐设计，实用且低调，全盖式外壳成就极简一体化的艺术诉求。

一体式结构

保证便捷高效的安装体验

新隐形底座安装，拧紧螺丝即可安装，免划线，便捷高效。

Description 产品名称	Item No. 产品型号	Overlay 盖位	Base Plate Height / Holes 底座高度 / 开孔数量	Head cup size 铰杯开孔尺寸 (直径 x 深度 ΦxD)	Opening Angle 开门角度	Surface Treatment 表面处理
一字底座铰链 Wingless hinge	8152021	直臂固装 Full Overlay	H=0, 2孔 (Holes)	Φ35x11.5mm	100°	镀枪黑
	8152022	中弯固装 Half Overlay	H=0, 2孔 (Holes)	Φ35x11.5mm	100°	Electroplating Black
	8152023	大弯固装 Inserted	H=0, 2孔 (Holes)	Φ35x11.5mm	100°	
一字底座铰链盖 Cover for wingless hinge	8152021A	直臂 Full Overlay	/	/	/	波尔多红 Bordeaux red
	8152020A	中弯 / 大弯 Half Overlay / Inserted	/	/	/	
	8152021B	直臂 Full Overlay	/	/	/	香槟金 Champagne golden
	8152020B	中弯 / 大弯 Half Overlay / Inserted	/	/	/	
	8152021C	直臂 Full Overlay	/	/	/	太郎灰 Highclass grey
	8152020C	中弯 / 大弯 Half Overlay / Inserted	/	/	/	



WINGLESS HINGE FOR ALUMINIUM-FRAME DOOR  
一字底座铝框门铰链



Full Overlay  
直臂

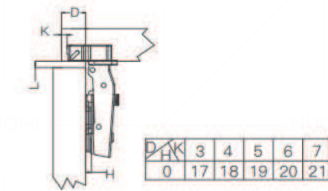

Hole Size  
钻孔尺寸

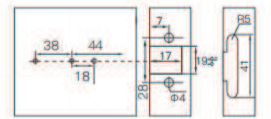

Half Overlay  
中弯

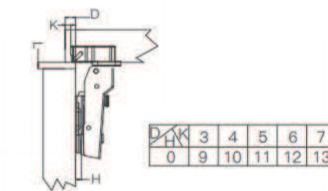

Hole Size  
钻孔尺寸



Inserted  
大弯

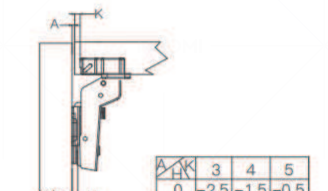

Hole Size  
钻孔尺寸



Description 产品名称	Item No. 产品型号	Overlay 盖位	Base Plate Height / Holes 底座高度 / 开孔数量	Hole Size 钻孔尺寸	Opening Angle 开门角度	Surface Treatment 表面处理
一字底座铝框门铰链 Wingless hinge for aluminium-frame door	8152121	直臂固装 Full Overlay	H=0, 2孔 (Holes)	28mm	100°	镀枪黑
	8152122	中弯固装 Half Overlay	H=0, 2孔 (Holes)	28mm	100°	Electroplating Black
	8152123	大弯固装 Inserted	H=0, 2孔 (Holes)	28mm	100°	
一字底座铝框门铰链盖 Cover for wingless hinge of aluminium-frame door	8152021A	直臂 Full Overlay	/	/	/	波尔多红 Bordeaux red
	8152020A	中弯 / 大弯 Half Overlay / Inserted	/	/	/	
	8152021B	直臂 Full Overlay	/	/	/	香槟金 Champagne golden
	8152020B	中弯 / 大弯 Half Overlay / Inserted	/	/	/	
	8152021C	直臂 Full Overlay	/	/	/	太郎灰 Highclass grey
	8152020C	中弯 / 大弯 Half Overlay / Inserted	/	/	/	



# LUXURIANCE SERIES

灵曜系列(N款)



Quick installation and removal of high-end damping hinges, integration of new technology, original design and operational comfort in one, uniform load, greater load bearing, comprehensive upgrade of functions. The revolutionary surface treatment technology makes it have excellent anti-rust ability, time-hardened, and always perfect.

快速安装拆卸的高端阻尼铰链，集新技术、独创设计和微小空间内的高度操作舒适性于一体，受力均匀，更大承重，功能性全面升级。革命性表面处理技术，使其具有超强抗锈能力，时光淬炼，始终完美。





## INGENIOUS DESIGN

精巧设计

诺米铰链将强悍的功能与精致的设计完美融合，无论在厨房、卧室、洗手间还是客厅，让您在每个家居空间都有完美的铰链使用体验。

The NUOMI hinge perfectly integrates the powerful function with the exquisite design. No matter in the kitchen, bedroom, washroom or living room, you can have the perfect hinge experience in every household space.



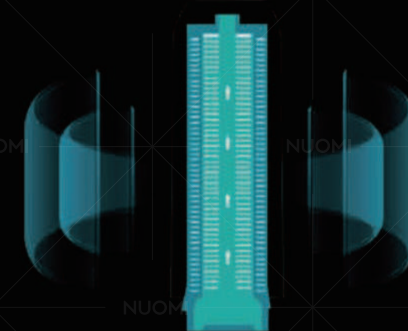

缓冲阻尼，使用寿命长久

## SUPER STRONG HYDRAULIC SYSTEM

超强液压系统

加长油缸采用锻造工艺，缸壁厚度匀称，油量更多。静音开合，阻尼使用寿命更长。

The lengthening cylinder adopts forging technology, the thickness of cylinder wall is symmetrical, and the oil quantity is more. Silent opening and closing, longer damping service life.



# MEET THE REQUIREMENTS OF DIFFERENT PLATE THICKNESS

满足不同板型厚度需求

- 适用 14-22mm 门板厚度
  - 覆盖 15-21mm 侧板厚度
  - 正负 4.5mm 大范围调节
  - 门板缝隙小于 1mm
- Available for door thickness between 14-22mm
  - Cover side-board thickness between 15-21mm
  - Adjustable range  $\pm 4.5\text{mm}$
  - Door gap less than 1mm





# TITANIUM PLATED HINGE IN ASH-BLACK COLOR

钛枪铰链

LUXURIANCE  
HIGH-END BUFFERING HINGE

灵曜  
高端阻尼铰链



## START HINGE REVOLUTION

钛枪色美学气息  
锤炼五金配件独特质感

外观高端，独具吸引力  
防腐防潮实用性更高

Innovatory nano titanium dry plating surface treatment  
make sure every component rust-resistant.

### 超级防锈

通过 48 小时盐雾测试

Super rust-resistant  
NU pass SGS 48 hours salty spray test.

### 机械动感造型

彰显科技力量

Mechanical dynamic style

### 钛枪色外观

与简欧轻奢家居风格完美契合

Tungsten titanium color



NANO TITANIUM HINGE TWO SECTION FORCE  
钛枪铰链二段力



快装



固装

Full Overlay  
直臂

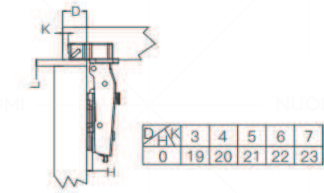

Hole Size  
钻孔尺寸

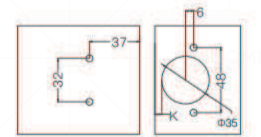

快装



固装

Half Overlay  
中弯

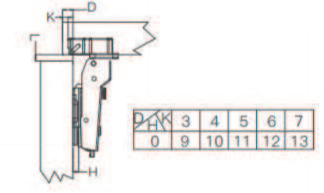

Hole Size  
钻孔尺寸

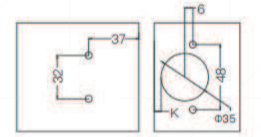

快装



固装

Inserted  
大弯

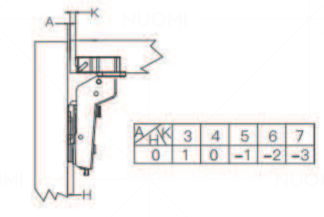

Hole Size  
钻孔尺寸

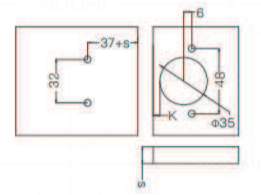

Item No. 产品型号	Overlay 盖位	Base Plate Height / Holes 底座高度 / 开孔数量	Head cup size 铰杯开孔尺寸 (直径 x 深度 $\Phi \times D$ )	Opening Angle 开门角度	Surface Treatment 表面处理	
快装 Fast mounted	固装 Fixed mounted					
8022511	8022521	直臂 Full Overlay	H=0, 4孔 (Holes)	$\Phi 35 \times 11.5 \text{mm}$	105°	镀枪黑 Nickel Electroplating ash black
8022512	8022522	中弯 Half Overlay	H=0, 4孔 (Holes)	$\Phi 35 \times 11.5 \text{mm}$	105°	
8022513	8022523	大弯 Inserted	H=0, 4孔 (Holes)	$\Phi 35 \times 11.5 \text{mm}$	105°	



FIXED MOUNTED HINGE FOR NARROW ALUMINUM FRAME  
窄铝框铰链 - 固装



Full Overlay  
直臂

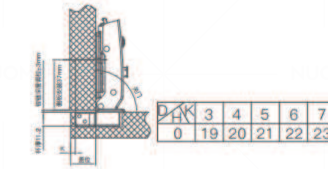

Hole Size  
钻孔尺寸

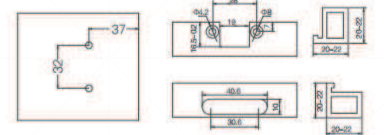

Half Overlay  
中弯

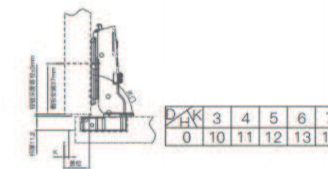

Hole Size  
钻孔尺寸

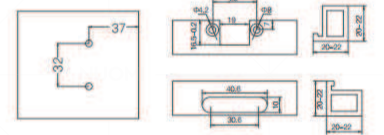

Inserted  
大弯

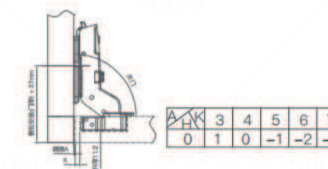

Hole Size  
钻孔尺寸

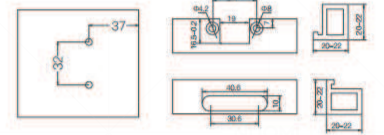

Item No. 产品型号	Overlay 盖位	Base Plate Height / Holes 底座高度 / 开孔数量	Hole Size 钻孔尺寸	Head cup size 铰杯开孔尺寸 (直径 x 深度 ΦxD)	Opening Angle 开门角度	Surface Treatment 表面处理
8022501	直臂固装 Full Overlay	H=0, 4 孔 (Holes)	28mm	Φ35x11.5mm	105°	镀枪黑 Nickel Electroplating ash black
8022502	中弯固装 Half Overlay	H=0, 4 孔 (Holes)	28mm	Φ35x11.5mm	105°	
8022503	大弯固装 Inserted	H=0, 4 孔 (Holes)	28mm	Φ35x11.5mm	105°	



TWO-SECTION FORCE BUFFERING HINGE  
二段力阻尼铰链



		Full Overlay 直臂	Hole Size 钻孔尺寸
快装 Fast mounted	固装 Fixed mounted		
快装 Fast mounted	固装 Fixed mounted		
快装 Fast mounted	固装 Fixed mounted		

Item No. 产品型号	Overlay 盖位	Base Plate Height / Holes 底座高度 / 开孔数量	Head cup size 铰杯开孔尺寸 (直径 x 深度 $\Phi \times D$ )	Opening Angle 开门角度	Surface Treatment 表面处理
快装 Fast mounted	固装 Fixed mounted				
8022111	8022101	直臂 Full Overlay H=0, 4孔 (Holes)	$\Phi 35 \times 11.5 \text{mm}$	105°	镀镍 Nickel Electroplating
8022112	8022102	中弯 Half Overlay H=0, 4孔 (Holes)	$\Phi 35 \times 11.5 \text{mm}$	105°	
8022113	8022103	大弯 Inserted H=0, 4孔 (Holes)	$\Phi 35 \times 11.5 \text{mm}$	105°	



SMALL ANGLE TWO-SECTION FORCE BUFFERING HINGE  
小角度二段力阻尼铰链



快装



固装

Full Overlay  
直臂

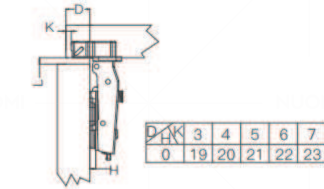

Hole Size  
钻孔尺寸

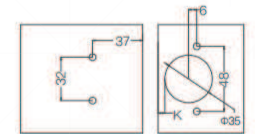

快装



固装

Half Overlay  
中弯

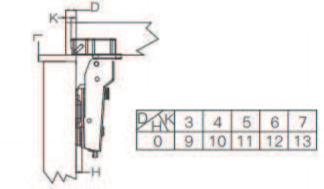

Hole Size  
钻孔尺寸

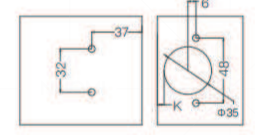

快装



固装

Inserted  
大弯

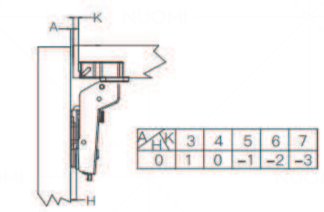

Hole Size  
钻孔尺寸

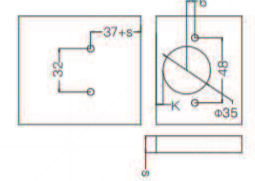

Item No. 产品型号	Overlay 盖位	Base Plate Height / Holes 底座高度 / 开孔数量	Head cup size 铰杯开孔尺寸 (直径 x 深度 $\Phi \times D$ )	Opening Angle 开门角度	Surface Treatment 表面处理
快装 Fast mounted	固装 Fixed mounted				
8022321	8022301	直臂 Full Overlay H=0, 4孔 (Holes)	$\Phi 35 \times 11.5 \text{mm}$	105°	镀镍 Nickel Electroplating Gun Ash
8022322	8022302	中弯 Half Overlay H=0, 4孔 (Holes)	$\Phi 35 \times 11.5 \text{mm}$	105°	镀枪黑 Nickel Electroplating Gun Ash
8022323	8022303	大弯 Inserted H=0, 4孔 (Holes)	$\Phi 35 \times 11.5 \text{mm}$	105°	镀枪黑 Nickel Electroplating Gun Ash
8022331	8022311	直臂 Full Overlay H=0, 4孔 (Holes)	$\Phi 35 \times 11.5 \text{mm}$	105°	镀枪黑 Nickel Electroplating Gun Ash
8022332	8022312	中弯 Half Overlay H=0, 4孔 (Holes)	$\Phi 35 \times 11.5 \text{mm}$	105°	镀枪黑 Nickel Electroplating Gun Ash
8022333	8022313	大弯 Inserted H=0, 4孔 (Holes)	$\Phi 35 \times 11.5 \text{mm}$	105°	镀枪黑 Nickel Electroplating Gun Ash





SMALL ANGLE TWO-SECTION FORCE BUFFERING HINGE FOR THICK DOOR  
厚门小角度二段力阻尼铰链



快装



固装

Full Overlay  
直臂

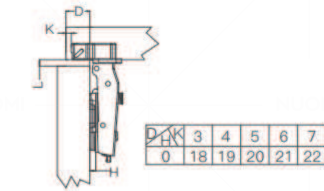

Hole Size  
钻孔尺寸

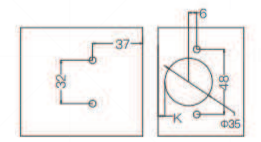

快装



固装

Half Overlay  
中弯

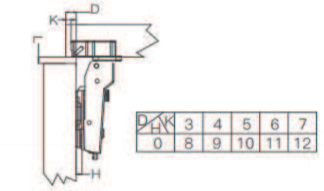

Hole Size  
钻孔尺寸

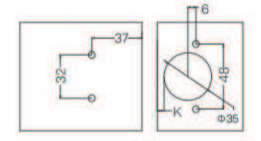

快装



固装

Inserted  
大弯

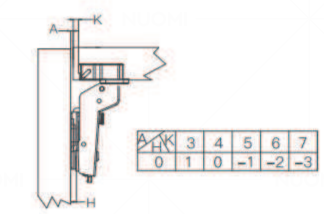

Hole Size  
钻孔尺寸

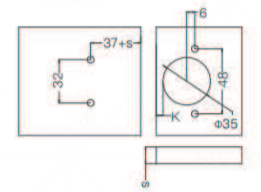

Item No. 产品型号	Overlay 盖位	Base Plate Height / Holes 底座高度 / 开孔数量	Head cup size 铰杯开孔尺寸 (直径 x 深度 ΦxD)	Opening Angle 开门角度	Surface Treatment 表面处理	
快装 Fast mounted	固装 Fixed mounted					
8022611	8022601	直臂 Full Overlay	H=0, 4 孔 (Holes)	Φ35x11.5mm	100°	镀镍 Nickel Electroplating Gun Ash
8022612	8022602	中弯 Half Overlay	H=0, 4 孔 (Holes)	Φ35x11.5mm	100°	镀枪黑 Nickel Electroplating Gun Ash
8022613	8022603	大弯 Inserted	H=0, 4 孔 (Holes)	Φ35x11.5mm	100°	镀枪黑 Nickel Electroplating Gun Ash
8022631	8022621	直臂 Full Overlay	H=0, 4 孔 (Holes)	Φ35x11.5mm	100°	镀枪黑 Nickel Electroplating Gun Ash
8022632	8022622	中弯 Half Overlay	H=0, 4 孔 (Holes)	Φ35x11.5mm	100°	镀枪黑 Nickel Electroplating Gun Ash
8022633	8022623	大弯 Inserted	H=0, 4 孔 (Holes)	Φ35x11.5mm	100°	镀枪黑 Nickel Electroplating Gun Ash



3D ADJUSTMENT QUICK MOUNTED TWO-SECTION FORCE BUFFERING HINGE  
 三维调节快装二段力阻尼铰链

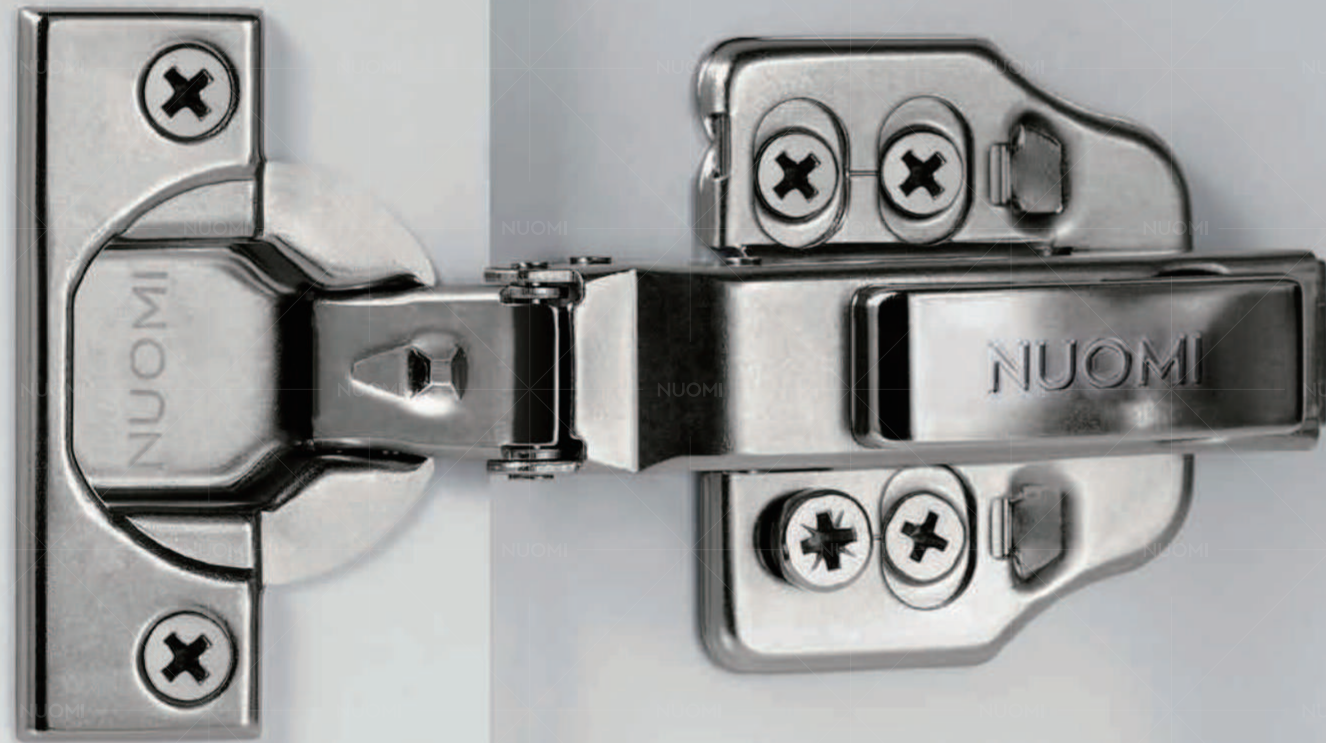

Full Overlay  
直臂

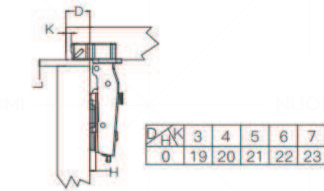

Hole Size  
钻孔尺寸

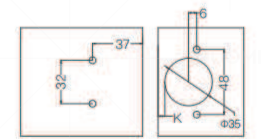

Half Overlay  
中弯

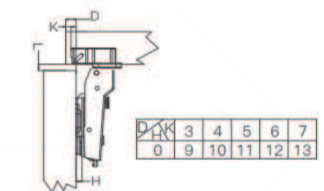

Hole Size  
钻孔尺寸

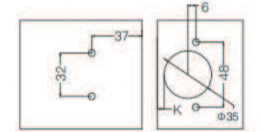

Inserted  
大弯

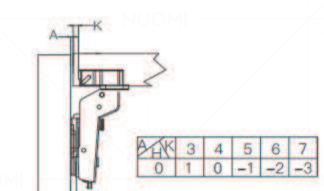

Hole Size  
钻孔尺寸

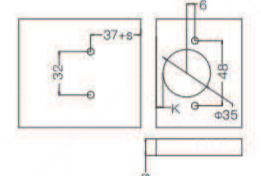

Item No. 产品型号	Overlay 盖位	Base Plate Height / Holes 底座高度 / 开孔数量	Head cup size 铰杯开孔尺寸 (直径 x 深度 $\Phi \times D$ )	Opening Angle 开门角度	Surface Treatment 表面处理
8022031	直臂 Full Overlay	H=0, 3 孔 (Holes)	$\Phi 35 \times 11.5 \text{mm}$	105°	电镀镍 Nickel Electroplating
8022032	中弯 Half Overlay	H=0, 3 孔 (Holes)	$\Phi 35 \times 11.5 \text{mm}$	105°	
8022033	大弯 Inserted	H=0, 3 孔 (Holes)	$\Phi 35 \times 11.5 \text{mm}$	105°	



# SURPRASS SERIES

灵越系列(T款)



---

Following the pure and simple design style, the appearance is dexterous and exquisite, and the operation is convenient. We continue to explore the experience of product use, showing a simple and exquisite style overall, showing the pursuit and profound interpretation of quality life in a low-key manner.

遵循着纯粹与简约的设计风格，外观灵巧精美，操作便捷。我们不断探索产品使用的体验，总体展现出简约精致的格调，在低调中展现出对品质生活的追求和深刻诠释。



FIXED MOUNTED ONE SECTION FORCE BUFFERING HINGE  
固装一段力阻尼铰链



Full Overlay  
直臂

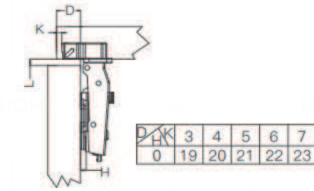

Hole Size  
钻孔尺寸

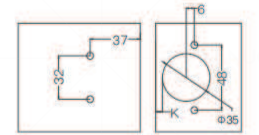

Half Overlay  
中弯

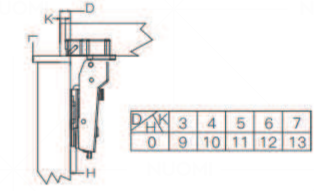

Hole Size  
钻孔尺寸

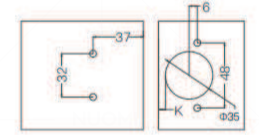

Inserted  
大弯

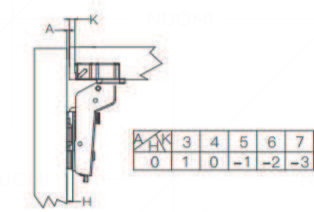

Hole Size  
钻孔尺寸

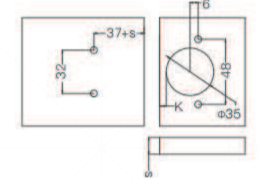

Item No. 产品型号	Overlay 盖位	Base Plate Height / Holes 底座高度 / 开孔数量	Head cup size 铰杯开孔尺寸 (直径 x 深度 ΦxD)	Opening Angle 开门角度	Surface Treatment 表面处理	
常规包装 Standard package	工业包装 Economical package	精包装 Premium package				
8011201	8011301	8011401	直臂 Full Overlay	H=0, 4 孔 (Holes)	Φ35x11.5mm	105°
8011202	8011302	8011402	中弯 Half Overlay	H=0, 4 孔 (Holes)	Φ35x11.5mm	105°
8011203	3011303	8011403	大弯 Inserted	H=0, 4 孔 (Holes)	Φ35x11.5mm	105°

电镀镍  
Nickel Electroplating



SUS304 HINGE FIXED MOUNTED ONE-SECTION FORCE  
固装一段力 304 不锈钢铰链



Full Overlay  
直臂

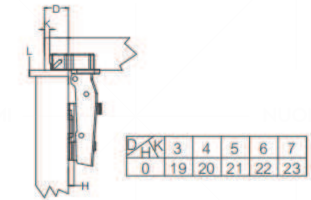

Hole Size  
钻孔尺寸

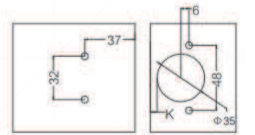

Half Overlay  
中弯

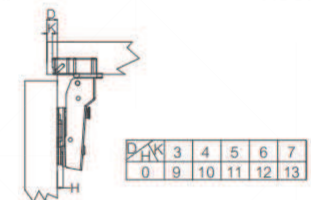

Hole Size  
钻孔尺寸

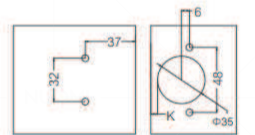

Inserted  
大弯

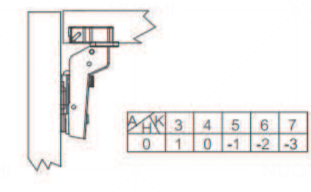

Hole Size  
钻孔尺寸

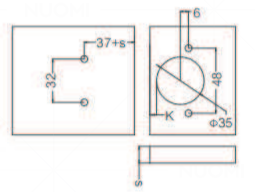

Item No. 产品型号	Overlay 盖位	Base Plate Height / Holes 底座高度 / 开孔数量	Head cup size 铰杯开孔尺寸 (直径 x 深度 $\Phi \times D$ )	Opening Angle 开门角度	Surface Treatment 表面处理
8051001	直臂 Full Overlay	H=0, 4 孔 (Holes)	$\Phi 35 \times 11.5 \text{mm}$	105°	304 不锈钢 SUS304
8051002	中弯 Half Overlay	H=0, 4 孔 (Holes)	$\Phi 35 \times 11.5 \text{mm}$	105°	
8051003	大弯 Inserted	H=0, 4 孔 (Holes)	$\Phi 35 \times 11.5 \text{mm}$	105°	



SUS201 FIXED MOUNTED ONE SECTION FORCE BUFFERING HINGE  
201 固装一段力阻尼铰链



Full Overlay  
直臂

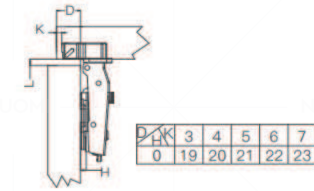

Hole Size  
钻孔尺寸

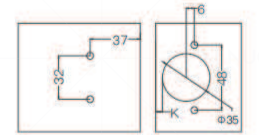

Half Overlay  
中弯

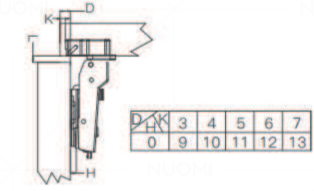

Hole Size  
钻孔尺寸

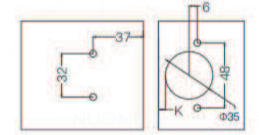

Inserted  
大弯

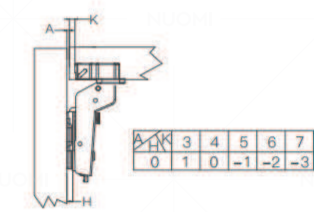

Hole Size  
钻孔尺寸

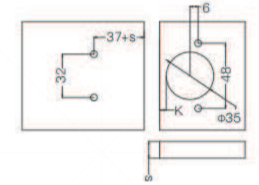

Item No. 产品型号	Overlay 盖位	Base Plate Height / Holes 底座高度 / 开孔数量	Head cup size 铰杯开孔尺寸 (直径 x 深度 $\Phi \times D$ )	Opening Angle 开门角度	Surface Treatment 表面处理
8052001	直臂 Full Overlay	H=0, 4 孔 (Holes)	$\Phi 35 \times 11.5 \text{mm}$	105°	电镀镍 Nickel Electroplating
8052002	中弯 Half Overlay	H=0, 4 孔 (Holes)	$\Phi 35 \times 11.5 \text{mm}$	105°	
8052003	大弯 Inserted	H=0, 4 孔 (Holes)	$\Phi 35 \times 11.5 \text{mm}$	105°	



UNDAMPED HINGE  
无力铰链



Full Overlay  
直臂

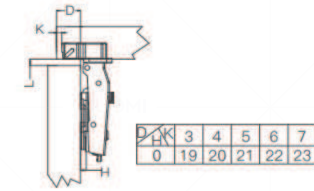

Hole Size  
钻孔尺寸

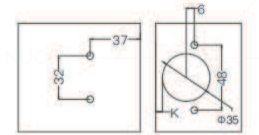

Half Overlay  
中弯

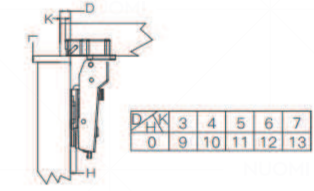

Hole Size  
钻孔尺寸

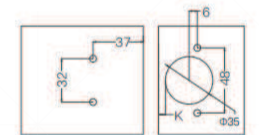

Inserted  
大弯

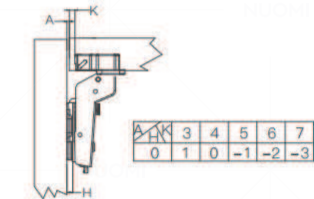

Hole Size  
钻孔尺寸

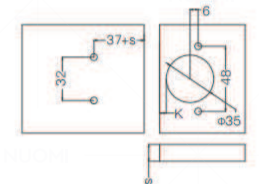

Item No. 产品型号	Overlay 盖位	Base Plate Height / Holes 底座高度 / 开孔数量	Head cup size 铰杯开孔尺寸 (直径 x 深度 $\Phi \times D$ )	Opening Angle 开门角度	Surface Treatment 表面处理
8011801	直臂 Full Overlay	H=0, 4孔 (Holes)	$\Phi 35 \times 11.5 \text{mm}$	105°	电镀镍 Nickel Electroplating
8011802	中弯 Half Overlay	H=0, 4孔 (Holes)	$\Phi 35 \times 11.5 \text{mm}$	105°	
8011803	大弯 Inserted	H=0, 4孔 (Holes)	$\Phi 35 \times 11.5 \text{mm}$	105°	



# SPECIAL HINGE

特殊系列



---

The angle processing is full of order, and the space is free and comfortable. Not much pretentiousness, with the high rationality of modernism, reducing the constituent elements of the furnishings, and the calm temperament of the colors, revealing the beauty of freehand in modern minimalism, simple and elegant.

角度的处理充满着秩序感,空间自由而舒适。不多矫饰,以现代主义的高度理性,减少陈设的构成元素,色彩的冷静气质,于现代极简主义中流露出写意之美,简雅而素淡。



PIVOT HINGE  
轻型天地铰链



天地铰链角码  
Hinge base



天地铰链  
Pivot hinge

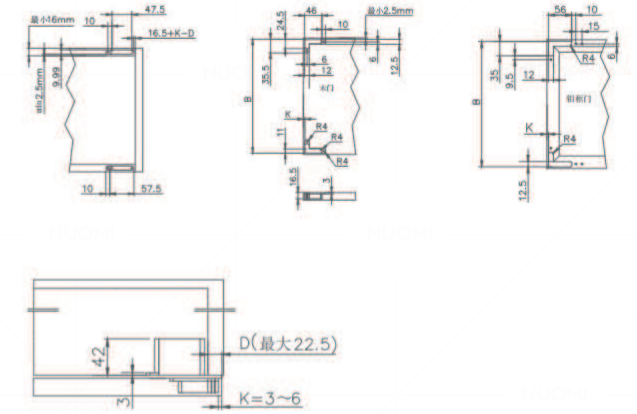

Description 产品名称	Item No. 产品型号	Overlay 盖位	Opening Angle 开门角度	Surface Treatment 表面处理
轻型天地铰链 Pivot hinge	8110001	/	*	电镀枪黑色 Electroplating Black
轻型天地铰链角码 Base of pivot hinge	8110002	/	*	

承重 Load-bearing : 25kg







FAST MOUNTED 165° BUFFERING HINGE  
165° 阻尼铰链 - 快装



Full Overlay  
直臂

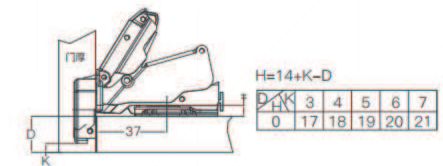

Hole Size  
钻孔尺寸

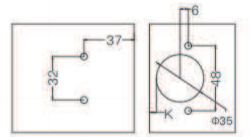

Half Overlay  
中弯



Hole Size  
钻孔尺寸

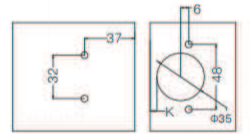

Inserted  
大弯

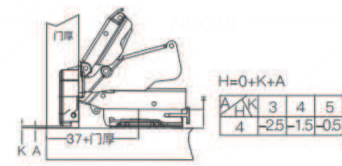

Hole Size  
钻孔尺寸

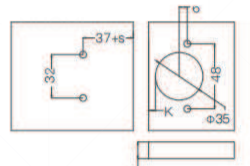

Item No. 产品型号	Overlay 盖位	Base Plate Height / Holes 底座高度 / 开孔数量	Hole Size 钻孔尺寸	Head cup size 铰杯开孔尺寸 (直径 x 深度 ΦxD)	Opening Angle 开门角度	Surface Treatment 表面处理
8072021	直臂快装 Full Overlay	H=0, 4 孔 (Holes)	48mm	Φ35x11.5mm	165°	电镀镍 Nickel Electroplating
8072022	中弯快装 Half Overlay	H=0, 4 孔 (Holes)	48mm	Φ35x11.5mm	165°	
8072023	大弯快装 Inserted	H=0, 4 孔 (Holes)	48mm	Φ35x11.5mm	165°	





45° BUFFERING HINGE  
45° 阻尼铰链 8101010

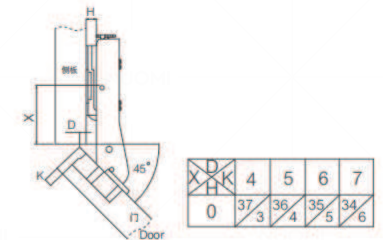

Hole Size 钻孔尺寸

90° SLIDING DOOR BUFFERING HINGE  
90° 平门阻尼铰链 8091010

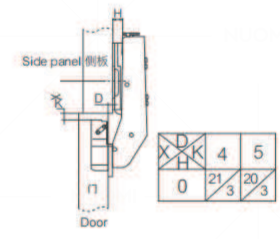

Hole Size 钻孔尺寸

135° HINGE  
135° 铰链 8080000

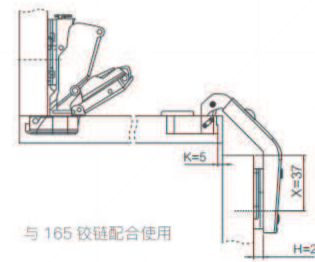

Hole Size 钻孔尺寸

Item No. 产品型号	Base Plate Height / Holes 底座高度 / 开孔数量	Head cup size 铰杯开孔尺寸 (直径 x 深度 ΦxD)	Opening Angle 开门角度	Surface Treatment 表面处理
8101010	H=0, 4 Holes	Φ35x11.5mm	45°	电镀镍 Nickel Electroplating
8091010	H=0, 4 Holes	Φ35x11.5mm	90°	
8080000	H=0, 4 Holes	Φ35x11.5mm	135°	



# SLIDE

滑轨系统





# MEHR SERIES

迈赫系列

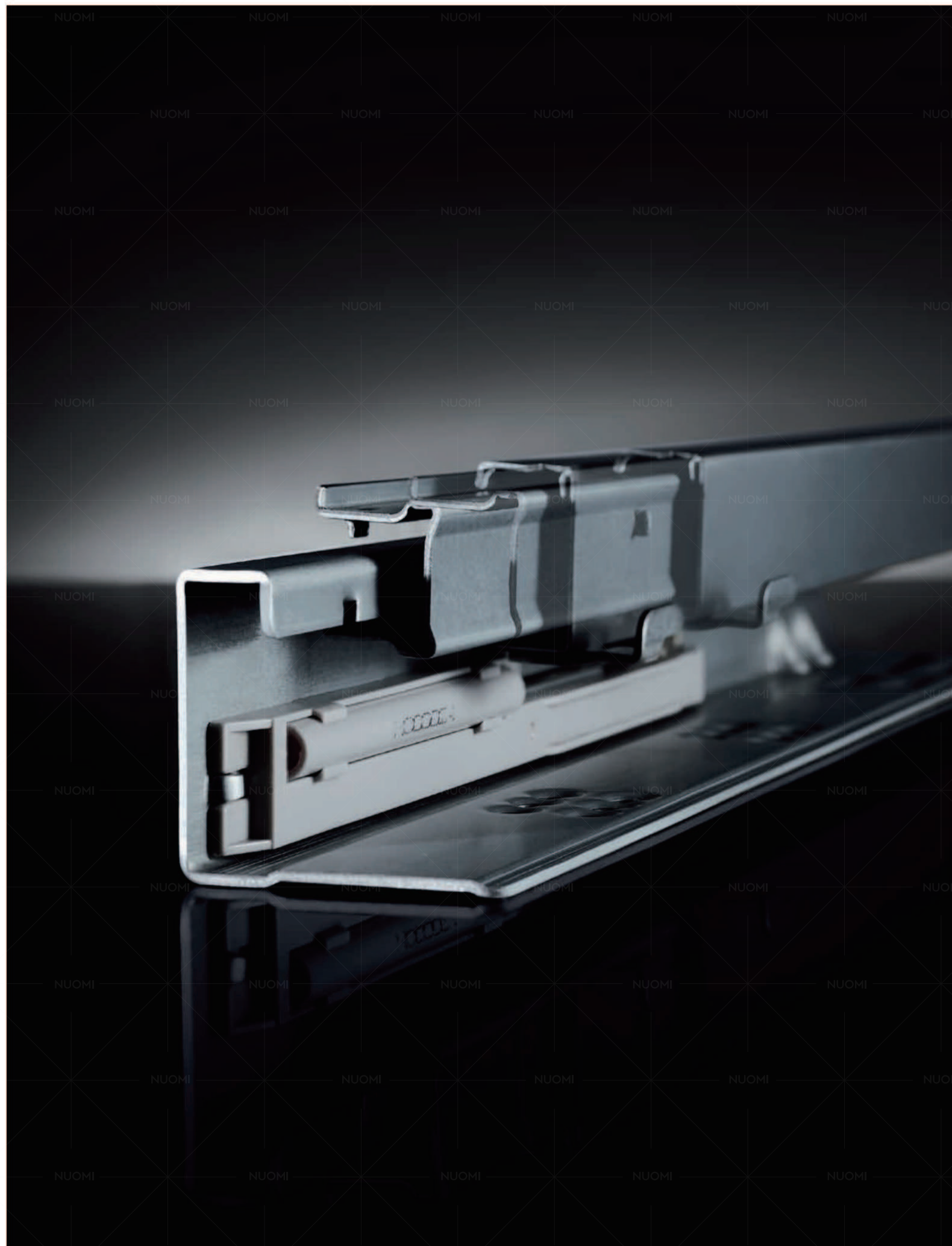

MEHR synchronous slide, soft opening, smooth movement, closing soft and silent. Full extension design, make the best use of drawer space, superior load bearing, more stable and longer service life.

迈赫同步滑轨,开启轻盈便捷,运动同步顺滑,关闭缓冲静谧,全拉出设计空间利用率更高,超强承重能力性能更稳定耐用。



# SYNCHRONOUS SLIDING LIGHT AND SMOOTH

同步滑动 轻盈顺畅

- 开启轻盈便捷、关闭缓冲静谧
  - 运动同步顺滑
  - 全拉出设计
  - 承重能力更大，稳定耐用
  - 卡扣式快装及三维调节，安装快捷
- Convenient opening, soft and silent closing
  - Synchronous and smooth movement
  - Full extension pull-out design
  - Stronger load bearing, stable and durable
  - Clip-on type fast mounted, 3d adjustment





# MEHR CONCEALED SYNCHRONOUS DAMPING SLIDE

## 迈赫隐藏式同步阻尼滑轨



### 产品特点 FEATURES

- 隐藏式设计轨道不外露  
三节滑轨，既美观又大大提升空间利用率
- 推拉顺滑，轻柔缓冲  
抽拉顺滑，闭合轻柔，减少噪音
- 全拉出同步三节轨设计  
250mm-550mm 滑轨长度，抽屉同步全拉出，便于拿取物品
- 优选镀锌板料正材制作  
采用镀锌板料，通过 48 小时盐雾测试
- 厚料结实，30kg 强悍承重  
硬度高，稳妥耐用，满足更大的承载需求物品
- 超长使用寿命，经久耐用  
韧性 & 硬度兼备，80000 次抽拉测试，抽拉顺滑不易变形
- 一键拆卸，抽屉清洁不费力  
按码器一键按压即可拆卸
- 三维立体调节  
以 ±3mm 的上下高度调节范围，可根据需要调整所需高度
- The hidden design track is not exposed  
The three-section slide rail is not only beautiful but also greatly improves the utilization rate of space.
- Smooth push and pull, soft cushioning  
The draw is smooth, the closure is soft and the noise is reduced.
- Full extension synchronous three-section rail design  
The length of the slide rail is 250mm-550mm, and the drawers are fully pulled out synchronously.
- Electro-galvanized process, moisture-proof and durable  
The neutral salt spray test lasts up to 48 hours, which doubles the corrosion resistance.
- Thick material is strong, 30kg strong load-bearing  
High hardness, safe and durable, to meet the greater load-bearing requirements.
- Super long service life, durable  
Both toughness and hardness, 80,000 times of pulling test, smooth pulling and not easy to deform.
- One-button detachment, easy to clean the drawer  
The code connector can be disassembled by pressing
- Three-dimensional adjustment  
With ±3mm up and down height adjustment range, the desired height can be adjusted as needed.

### Description 产品描述

动态负重: 30Kg(10"-22")

材质: 镀锌板

材料厚度: (上、中、下)1.0/1.5/1.8mm

带快速拆装把手, 抽屉可轻松拆卸安装

您只需轻轻地转动调节齿轮就可以轻松地调整高度

可选产品规格: 250-550mm

单位: mm

Dynamic Load: 30kg(10"-22")

Material: Galvanized Plate

Material Thickness: (upper, middle, bottom)1.0/1.5/1.8mm

with quickly mounted handle, easy to disassemble the drawer

slightly turn the adjusting gear can adjust the height easily

Optional specification: 250-550mm

Unit: mm

Description 产品名称	Item No. 产品型号	Nominal Length 标称长度	Drawer Length 抽屉长度 L-10	Min Depth 最小柜深
	7036251	250	240	265
	7036301	300	290	315
隐藏式同步阻尼滑轨 (带把手)	7036351	350	340	365
Concealed synchronous Damping slide (with handle)	7036401	400	390	415
	7036451	450	440	465
	7036501	500	490	515
	7036551	550	540	565

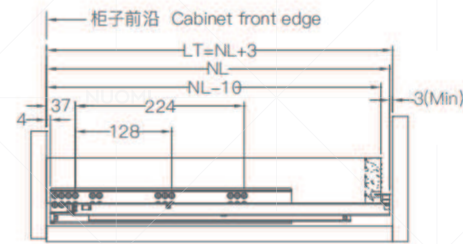

外置抽屉 Standard drawer

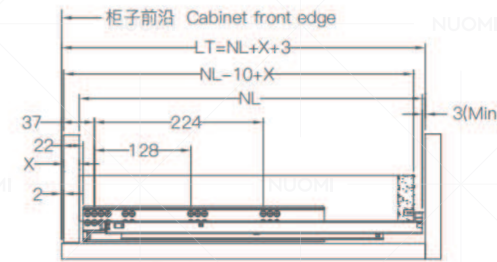

内置抽屉 Internal drawer

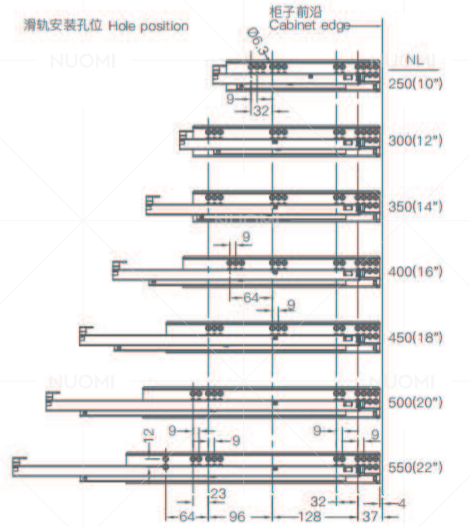
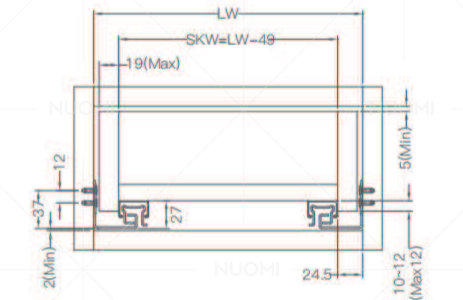

抽屉尺寸和钻孔(mm) Drawer size and drilling

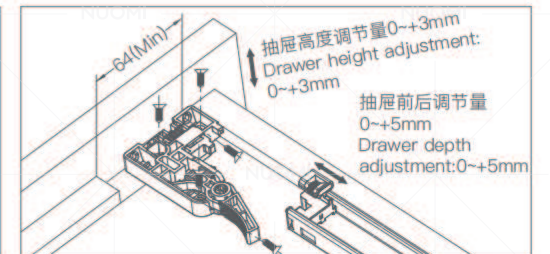
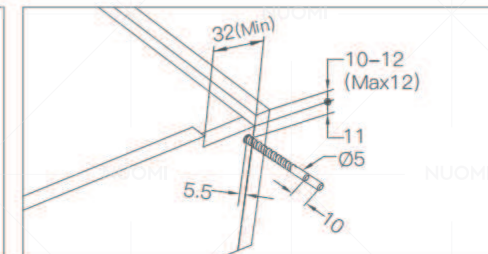
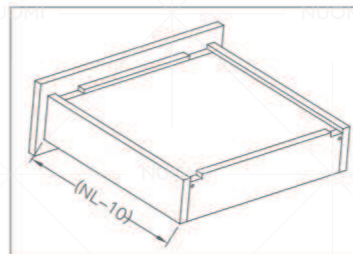



# CONCEALED SYNCHRONOUS REBOUNDED SLIDE

## 迈赫隐藏式同步反弹滑轨



### Description 产品描述

动态负重: 30Kg(10"-22")

材质: 镀锌板

材料厚度: (上、中、下)1.0/1.5/1.8mm

带快速拆装把手, 抽屉可轻松拆卸安装

您只需轻轻地转动调节齿轮就可以轻松地调整高度

可选产品规格: 250-550mm

单位: mm

Dynamic Load: 30kg(10"-22")

Material: Galvanized Plate

Material Thickness: (upper, middle, bottom)1.0/1.5/1.8mm

with quickly mounted handle, easy to disassemble the drawer

slightly turn the adjusting gear can adjust the height easily

Optional specification: 250-550mm

Unit: mm

Description 产品名称	Item No. 产品型号	Nominal Length 标称长度	Drawer Length 抽屉长度 L-10	Min Depth 最小柜深
	7037252	250	240	265
	7037302	300	290	315
隐藏式同步反弹滑轨 (带把手)	7037352	350	340	365
Concealed synchronous Rebounding slide (with handle)	7037402	400	390	415
	7037452	450	440	465
	7037502	500	490	515
	7037552	550	540	565
平衡杆 Balance rod	7037002	1100	/	/

建议 600mm 以上柜体搭配平衡杆使用 Suggest cabinet width ≥ 600mm match with balance rod.

### 产品特点 FEATURES

- 同步反向弹力系统  
轻轻一压, 弹簧弹出同步带动滑轨, 实现平衡弹出效果
- 隐藏式设计轨道不外露  
三节滑轨, 既美观又大大提升空间利用率
- 推拉顺滑, 轻柔缓冲  
抽拉顺滑, 闭合轻柔, 减少噪音
- 全拉出同步三节轨设计  
250mm-550mm 滑轨长度, 抽屉同步全拉出, 便于拿取物品
- 优选镀锌板料正材制作  
采用镀锌板料, 通过 48 小时盐雾测试
- 厚料结实, 30kg 强悍承重  
硬度高, 稳妥耐用, 满足更大的承载需求物品
- 超长使用寿命, 经久耐用  
韧性及硬度兼备, 50000 次抽拉测试, 抽拉顺滑不易变形
- 一键拆卸, 抽屉清洁不费力  
接码器一键按压即可拆卸
- 三维立体调节  
以 ±3mm 的上下高度调节范围, 可根据需要调整所需高度
- Synchronized reverse elastic system  
Gently press, the spring pops up and drives the slide rail synchronously to achieve a balanced pop-up effect.
- The hidden design track is not exposed  
The three-section slide rail is not only beautiful but also greatly improves the utilization rate of space.
- Smooth push and pull, soft cushioning  
The draw is smooth, the closure is soft and the noise is reduced.
- Full pull out synchronous three-section rail design  
The length of the slide rail is 250mm-550mm, and the drawers are fully pulled out synchronously.
- Electro-galvanized process, moisture-proof and durable  
The neutral salt spray test lasts up to 48 hours to level 8, which doubles the corrosion resistance.
- Thick material is strong, 30kg strong load-bearing  
High hardness, safe and durable, to meet the greater load-bearing requirements.
- Super long service life, durable  
Both toughness and hardness, 50,000 times of pulling test, smooth pulling and not easy to deform.
- One-button detachment, easy to clean the drawer  
The code connector can be disassembled by pressing.
- Three-dimensional adjustment  
With ±3mm up and down height adjustment range, the desired height can be adjusted as needed.

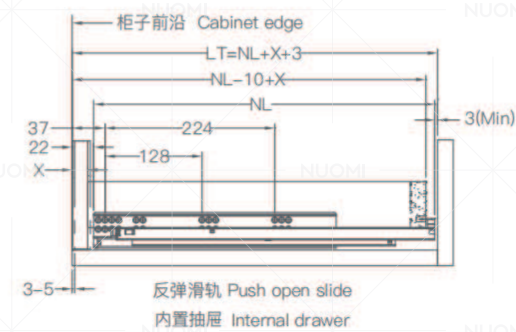
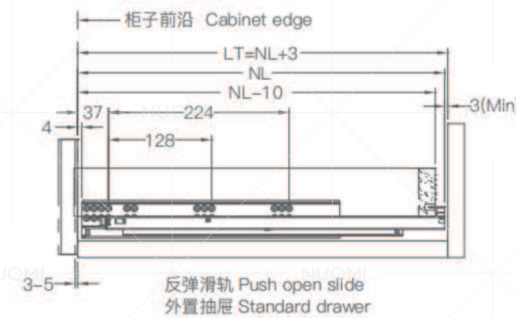

抽屉尺寸和钻孔(mm) Drawer size and drilling

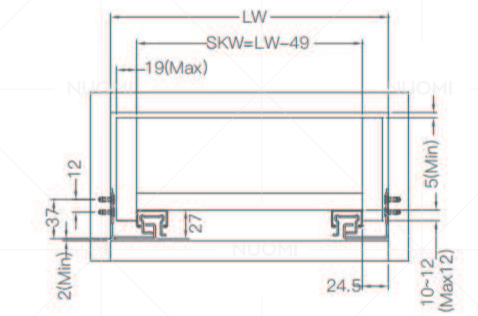
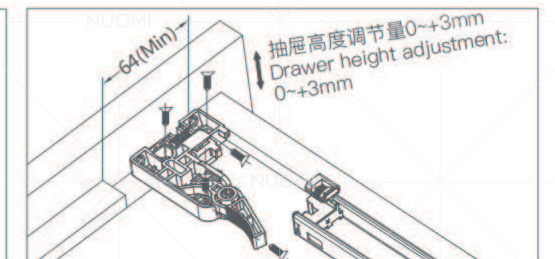
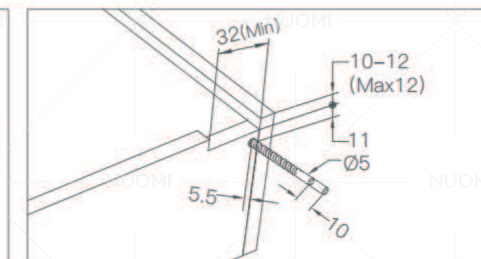
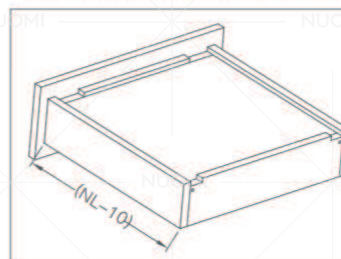

滑轨安装孔位 Hole position

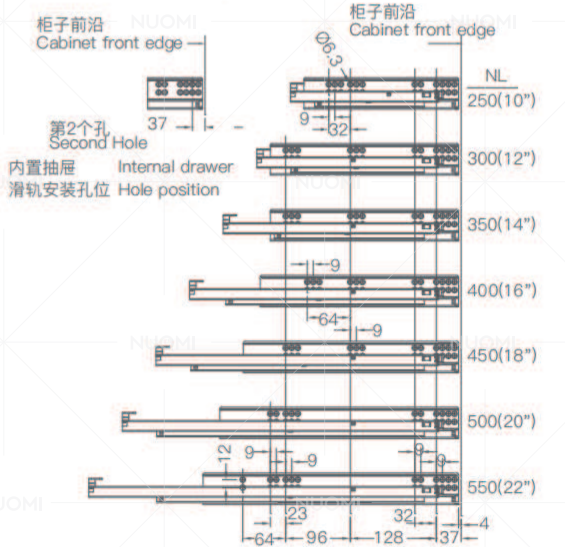



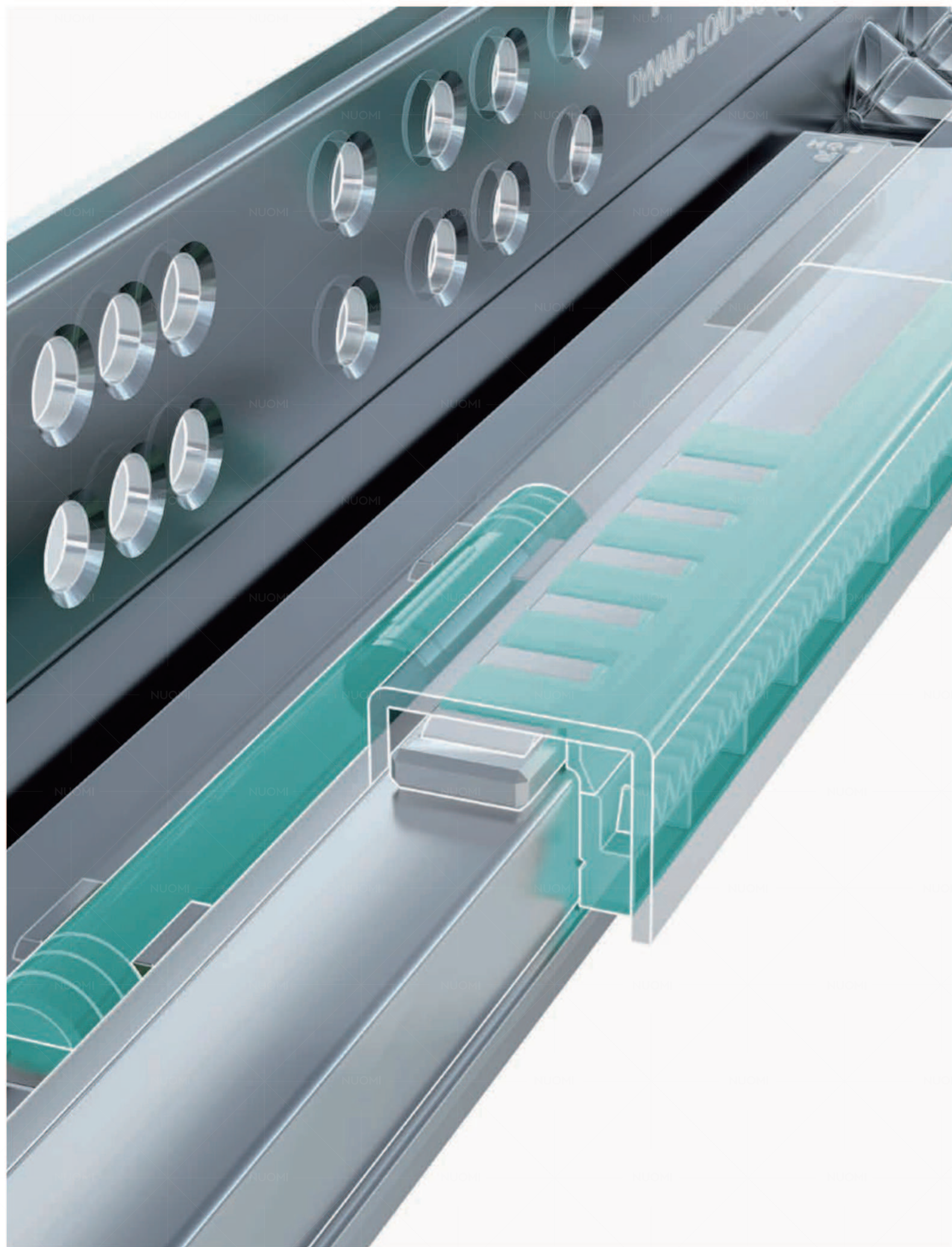

# EASE MAIHER SERIES

逸驰系列

---

EASE high-end hidden damping slide, light sliding when pushing, quiet and noiseless. In the design concept of taking people as the starting point, following the pure and beautiful style of the product, focusing on making each set of products to the extreme, the achievement is highly satisfied in both experience and aesthetics.

逸驰高端隐藏式阻尼滑轨，推拉时滑动轻盈，静音无噪。在以人为出发点的设计理念中，遵循产品纯粹至美的风格，专注把每一套产品做到极致，成就无论是体验上还是美观上的高度满足。



# EASE HIGH-END CONCEALED BUFFERING SLIDE

逸驰隐藏式阻尼滑轨

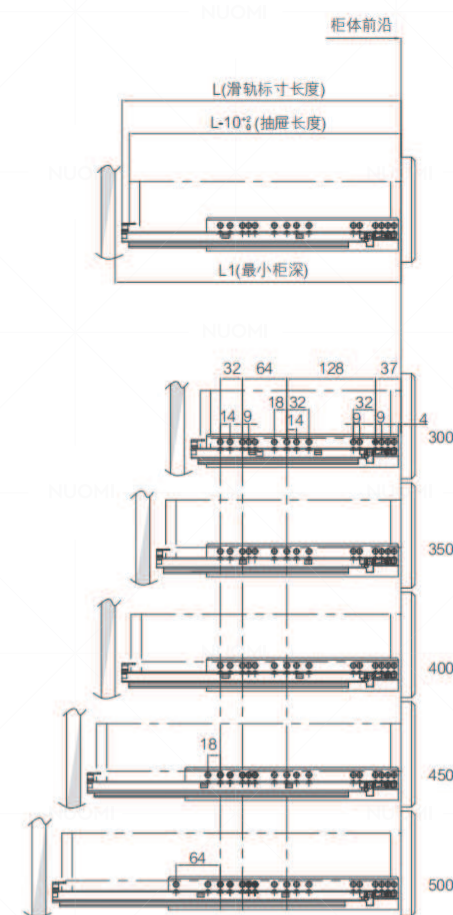
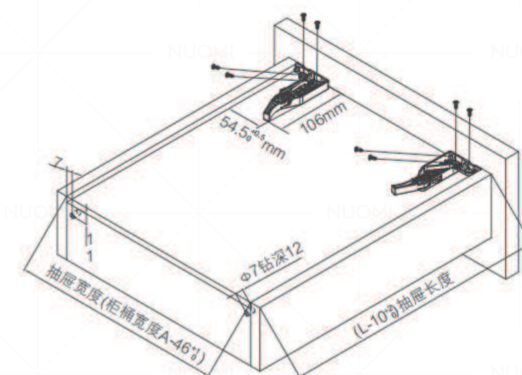
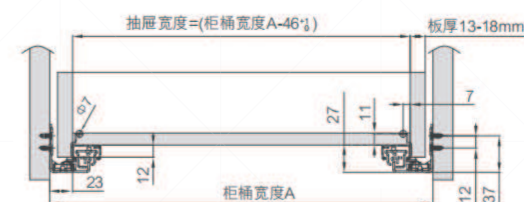

## Description 产品描述

动态负重: 30Kg(12"-20")

材质: 镀锌板

材料厚度: (上、中、下)1.0/1.5/1.8mm

带快速拆装把手, 抽屉可轻松拆卸安装

您只需轻轻地转动调节齿轮就可以轻松地调整高度

可选产品规格: 300-500mm

单位: mm

Dynamic Load: 30kg(12"-20")

Material: Galvanized Plate

Material Thickness: (upper, middle, bottom)1.0/1.5/1.8mm

with quickly mounted handle, easy to disassemble the drawer

slightly turn the adjusting gear can adjust the height easily

Optional specification: 300-500mm

Unit: mm

Description 产品名称	Item No. 产品型号	Nominal Length 标称长度	抽层长度 L-10	Min Depth 最小柜深
高端隐藏式阻尼三节滑轨 (带把手)	7031301	300	290	315
High-end Concealed Trinodal Buffering Slide (with handle)	7031351	350	340	365
	7031401	400	390	415
	7031451	450	440	465
	7031501	500	490	515





# SALLY SERIES

飒利系列



EASE high-end hidden damping slide, light sliding when pushing, quiet and noiseless. In the design concept of taking people as the starting point, following the pure and beautiful style of the product, focusing on making each set of products to the extreme, the achievement is highly satisfied in both experience and aesthetics.

逸驰高端隐藏式阻尼滑轨，推拉时滑动轻盈，静音无噪。在以人为出发点的设计理念中，遵循产品纯粹至美的风格，专注把每一套产品做到极致，成就无论是体验上还是美观上的高度满足。



# SALLY CONCEALED TWO-SECTION DAMPING SLIDE CLOSE TO FULL-EXTENTION

## 飒利隐藏式阻尼二节小全拉滑轨



### Description 产品描述

动态负重: 20Kg  
 材质: 镀锌板, 1.4x1.4  
 拉出深度: > 90%  
 抽屉高度调节量 0~+3mm  
 快速安装和拆卸, 您只需轻轻地转动调节齿轮  
 就可以轻松地调整高度  
 可选产品规格: 250-450mm  
 单位: mm  
 Dynamic Load: 20kg  
 Material: Galvanized Plate, 1.4x1.4  
 Pull out depth: > 90%  
 Drawer height adjustment 0~+3mm  
 Installed and removed quickly, slightly turn the adjusting gear  
 can adjust the height easily  
 Optional specification: 250-450mm  
 Unit: mm

Description 产品名称	Item No. 产品型号	Nominal Length 标称长度	Drawer Length 抽屉长度
	7032205	245	220
	7032255	275	240
隐藏式阻尼二节小全拉滑轨 (带插销)	7032305	325	290
concealed synchronous damping slide (with latch)	7032355	375	340
	7032405	425	390
	7032455	475	440

### 产品特点 FEATURES

- 二节小全拉设计, 更远行程  
拉出行程达 90%, 便于拿取物品
- 隐藏式托底设计, 颜值升级  
轨道不外露, 优雅美观; 二节滑轨, 抽屉空间黄金利用率
- 推拉顺滑, 轻柔缓冲  
抽拉顺滑, 闭合轻柔, 减少噪音
- 优选镀锌板料正材制作  
采用镀锌板料, 通过 48 小时盐雾测试
- 厚料结实, 20kg 强悍承重  
硬度高, 稳妥耐用, 满足更大的承载需求物品
- 超长使用寿命, 经久耐用  
韧性 & 硬度兼备, 50000 次抽拉测试, 抽拉顺滑不易变形
- Two-section close to full-extension design, longer stroke  
Pull out stroke up to 90%, easy access to items.
- Hidden backing design, upgraded appearance  
The track is not exposed; two-section slide rail, the golden utilization rate of drawer space.
- Smooth push and pull, soft cushioning  
Smooth pull, soft closing, less noise.
- Electro-galvanized process, moisture-proof and durable  
The neutral salt spray test lasts up to 48 hours, which doubles the corrosion resistance.
- Thick material is strong, 20kg strong load-bearing  
High hardness, safe and durable, to meet the greater load-bearing requirements.
- Super long service life, durable  
Both toughness and hardness, 50,000 times of cycles test, smooth pulling and not easy to deform.

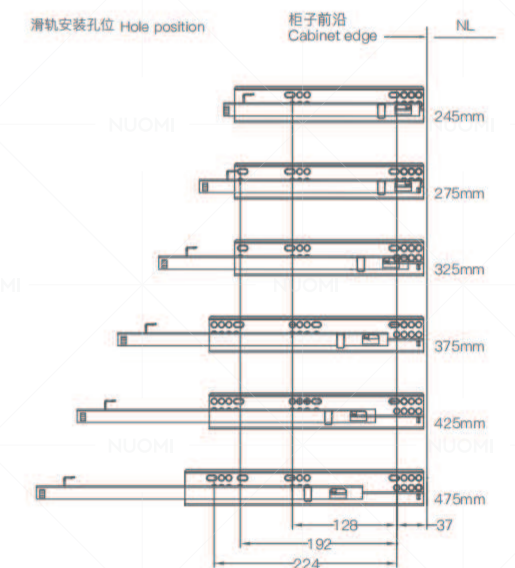
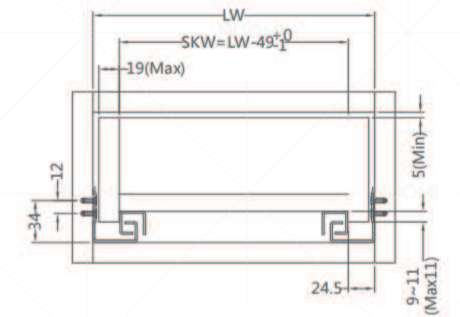
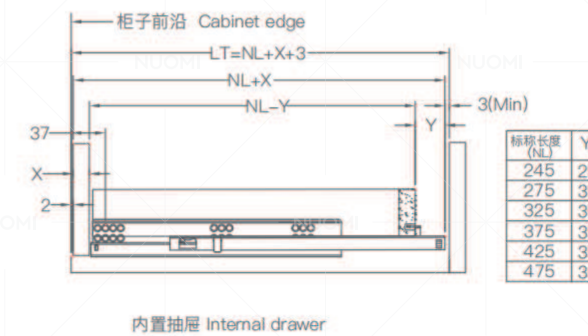
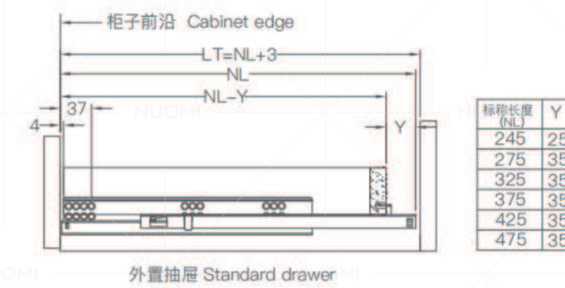

抽屉尺寸 Drawer size

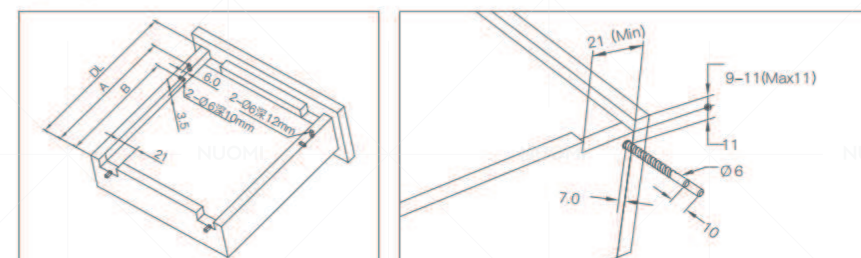

Min Depth 最小柜深	A	B
250	200	168
280	220	188
330	245	213
380	270	238
430	305	273
480	330	298





# YOUTH SERIES

悦动系列

Selected high-quality materials, ingenious craftsmanship. YOUTH high-end three-section steel ball slide rail, solid steel ball design, exquisite and round, bring excellent sliding performance, more natural and quiet during operation. The smooth slide lines present a dynamic trendy aesthetic that is unforgettable.

精选优质材料，匠心工艺品质。悦动高端三节钢珠滑轨，实心钢珠设计，颗颗精致圆润，带来极佳的滑动性能，运作时更加自然静音。流畅分明的滑轨线条呈现动感潮流美学，让人过目不忘。





## DETAIL ANALYSIS

**双弹簧与中油管组合设计，缓冲更均匀**

双弹簧有利于缓冲力度均匀，抽屉拉出手感轻盈，闭合力度更足。中置油缸与左右弹簧形成动态平衡作用力，闭合时缓冲效果更均匀。

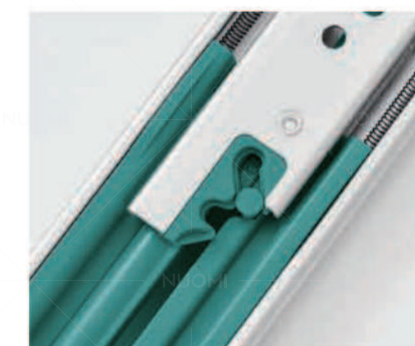
**触滑入式起动，大角度接触式滑入**

利用抽屉自重更轻易起动滑轨的缓冲功能、缓冲启动平稳、无卡顿或跳动。

**T形头设计，杜绝脱钩现象**

有效防止滑轨安装间隙过大或抽屉过宽，（大于70CM）拉出摆动过大的脱钩现象。

**缓冲器触发位置采用大幅度拐角设计，安全实用**

缓冲器触发位置上下完全贴合接触，抽屉全拉出时，非正常触发，如震动或者外部撞击柜体，均无法启动缓冲，做到真正的收放自如。

**双扣式设计，意外脱钩轻松自救**

当滑轨安装位置受柜体限制，必须深入柜体时（深入10mm以内），或安装有误滑轨主体伸入柜体过多时造成缓冲器脱钩失效，此设计可轻松自救重新恢复缓冲效果。

**缓冲器底部避空设计，安装更牢固**

锁定螺丝无障碍阻挡，更有利于短规格滑轨（16寸以下）的孔位排布，能做到滑轨的前后都有安装孔，而且都是木工排钻孔位，安装后滑轨更牢固。



# YOUTH BUFFERING TRINODAL BALL BEARING SLIDE

悦动三节阻尼钢珠滑轨



## Description 产品描述

负重: 1.0/1.0/1.2 (35Kg)  
 滑轨宽度: 45mm  
 材质: 冷轧钢板  
 表面处理: 电镀 (白色)、电泳 (黑色)  
 材质厚度:(外、中、内)轨: 1.0/1.0/1.2  
 先将抽屉拉出至定位, 再拨开内轨拨片, 抽屉可轻松拆卸安装  
 单位: mm

Load: 1.0/1.0/1.2 (35Kg)  
 Width of Slide: 45mm  
 Material: Cold-roll steel sheet  
 Surface treatment: electroplate(white), electrophoresis(black)  
 Material Thickness: (outer, middle, inner) part: 1.0/1.0/1.2  
 Pull out the drawer to terminal site, push aside the rotor disc of inner part of slide, easily assemble and disassemble the drawer  
 Unit: mm

Description 产品名称	Item No. 型号	Nominal Length 标称长度	Thickness 材质厚度
阻尼三节钢珠滑轨 (白色) Trinodal Buffering Ball Bearing Slide (white)	7041251	250mm	1.0/1.0/1.2
	7041301	300mm	
	7041351	350mm	
	7041401	400mm	
	7041451	450mm	
阻尼三节钢珠滑轨 (黑色) Trinodal Buffering Ball Bearing Slide (black)	7041501	500mm	1.0/1.0/1.2
	7041252	250mm	
	7041302	300mm	
	7041352	350mm	
	7041402	400mm	
7041452	450mm		
7041502	500mm		

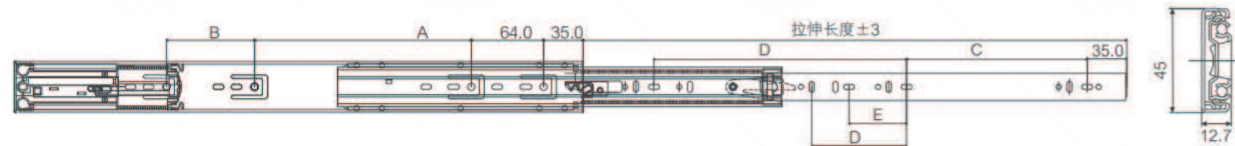

Description 产品名称	Specification 规格	Extension length 拉伸长度	A mm	B mm	C mm	D mm	E mm	F mm
阻尼三节钢珠滑轨 Trinodal Buffering Ball Bearing Slide	250	198	\	\	\	\	160	\
	300	262	64	\	96	\	\	112
	350	332	128	\	96	\	160	\
	400	382	160	\	128	160	\	\
	450	432	128	92	160	192	\	\
	500	482	192	78	192	192	\	\





# YOUTH HIGH-END TRINODAL BALL BEARING REBOUNING SLIDE

悦动三节反弹钢珠滑轨



## Description 产品描述

负重: 1.0/1.0/1.2 (35Kg)  
滑轨宽度: 45.7mm  
材质: 冷轧钢板  
表面处理: 电泳 (黑色)  
材质厚度:(外、中、内)轨: 1.0/1.0/1.2mm

Load: 1.0/1.0/1.2 (35Kg)  
Width of Slide: 45.7mm  
Material: Cold-roll steel sheet  
Surface treatment: electrophoresis(black)  
Material Thickness: (outer, middle, inner) part: 1.0/1.0/1.2mm

Description 产品名称	Item No. 型号	Nominal Length 标称长度	Thickness 材质厚度
	7045252	250mm	
	7045302	300mm	
反弹三节钢珠滑轨 (黑色)	7045352	350mm	1.0/1.0/1.2
Trinodal Buffering Ball Bearing Slide (Black)	7045402	400mm	
	7045452	450mm	
	7045502	500mm	

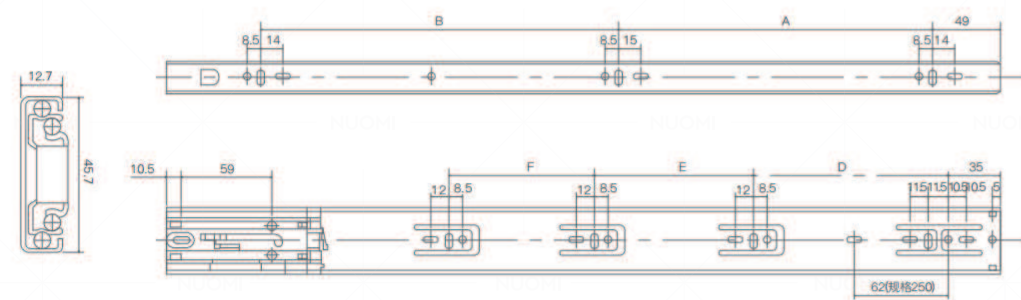

Description 产品名称	Specification 规格	Extension length 拉伸长度	A mm	B mm	D mm	E mm	F mm
	250	195	75	\	\	\	\
	300	280	80	105	96	\	\
三节反弹钢珠滑轨	350	350	128	106	72.5	64	\
Youth high-end trinodal Ball bearing rebounding slide	400	400	128	155	128	64	\
	450	450	160	160	128	104.5	\
	500	500	192	192	128	104.5	64





# YOUTH HIGH-END TRINODAL BALL BEARING SLIDE

悦动三节钢珠滑轨

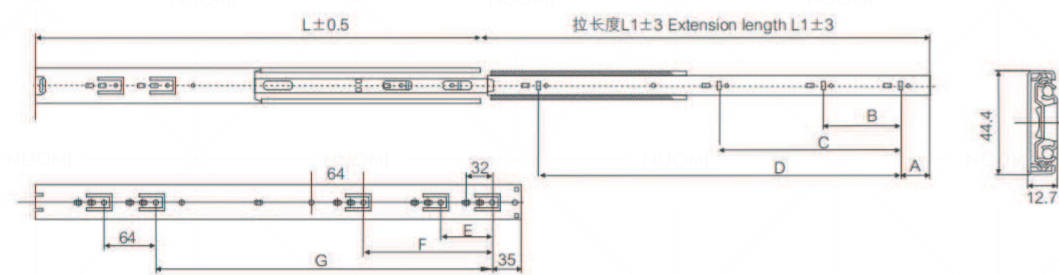

Description 产品名称	Specification 规格	Extension length 拉伸长度	A mm	B mm	C mm	D mm	E mm	F mm	G mm
三节钢珠滑轨 Trinodal Ball Bearing Slide	200	192	36	128	\	\	64	\	140
	250	242	36	169.4	\	\	64	\	140
	300	303	36	96	224	\	64	\	190
	350	388	36	128	256	\	64	\	192
	400	403	36	128	320	\	64	\	224
	450	483	36	160	352	\	64	\	288
	500	505	36	192	416	\	64	\	320

## Description 产品描述

负重: 1.0/1.0/1.2 (35Kg), 0.8/0.8/1.0 (25Kg)  
 滑轨宽度: 45mm  
 材质: 冷轧钢板  
 表面处理: 电泳  
 材质厚度:(外、中、内)轨: 1.0/1.0/1.2, 0.8/0.8/1.0  
 先将抽屉拉出至定位, 再拨开内轨拨片, 抽屉可轻松拆卸安装  
 单位: mm

Load: 1.0/1.0/1.2 (35Kg), 0.8/0.8/1.0 (25Kg)  
 Width of Slide: 45mm  
 Material: Cold-roll steel sheet  
 Surface treatment: electrophoresis  
 Material Thickness: (outer, middle, inner) part: 1.0/1.0/1.2, 0.8/0.8/1.0  
 Pull out the drawer to terminal site, push aside the rotor disc of inner part of slide, easily assemble and disassemble the drawer  
 Unit: mm

Description 产品名称	Item No. 型号	Nominal Length 标称长度	Thickness 材质厚度
三节钢珠滑轨 (黑色) Trinodal Ball Bearing Slide (black)	7043202	200mm	1.0/1.0/1.2
	7043252	250mm	
	7043302	300mm	
	7043352	350mm	
	7043402	400mm	
	7043452	450mm	0.8/0.8/1.0
	7043502	500mm	
	7044252	250mm	
	7044302	300mm	
	7044352	350mm	
7044402	400mm		
7044452	450mm		
7044502	500mm		







# SKYLIFT SERIES

## 上翻门系统

---

Flip-up lift system, simple, generous and high-grade. The built-in electric servo system ensures that the whole movement process is gentle and smooth, so as to form a light and easy opening and closing effect. Safe and stable operation, intelligent opening, make it more convenient to pick up and put items, and good products allow you to find the comfort and peace you haven't seen for a long time in the bustling city.

上翻电动平移门, 简单大方上档次。内置电动伺服系统, 保证整个运动过程轻柔、流畅, 以形成轻巧自如的开合效果。操作安全稳定, 智能开启, 让取放物品更方便, 好的产品让你在繁华的都市中找到久违的惬意与安宁。





FLIP-UP LIFT  
吊柜上翻支撑



Description  
产品描述

1. 快装底座设计：采用自定位方式，只需固定螺丝孔位即可完成安装，调节简单；
2. 缓冲阻尼装置：铜芯液压油封，密封性好；上翻缓冲，关门静音，保证开启使用寿命 35000 次；
3. 随意停止，取物方便：45°-107°范围可任意角度悬停，拿去物品更方便；
4. 加厚力臂，承重升级：可调节力度，采用冷轧钢一体成力臂，稳定牢固，长久使用不松动，max 承重 12kg；
5. 24 小时中性盐雾试验：表面多层镀铬处理，加倍耐腐防锈。

1. Quick-install base design: self-positioning method is adopted, and the installation can be completed by fixing the screw holes, and the adjustment is simple;
2. Buffer damping device: copper core hydraulic oil seal, good sealing; flip up buffer, The door is closed silently, and the service life of opening is guaranteed to be 350,00 times;
3. Stop at will, easy to pick up items: 45°-107° range can hover at any angle, and it is more convenient to take items;
4. Thickened force arm, load-bearing upgrade: adjustable strength, the force arm is made of cold-rolled steel, which is stable and firm, and will not loosen after long-term use. The maximum load-bearing capacity is 12kg;
5. 24-hour neutral salt spray test: the surface is multi-layer nickel-plated, which doubles the corrosion resistance and rust resistance.

所需空间

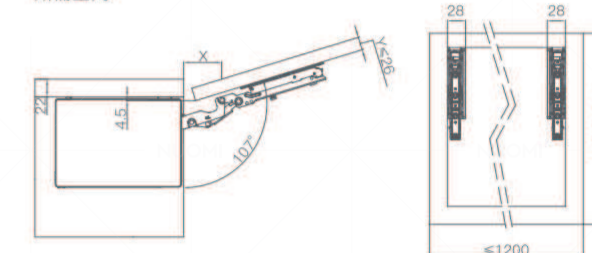

Description 产品名称	Item No. 产品型号	Door height 门高	Door weight 门重	load capacity 负载能力	Surface Treatment 表面处理
吊柜上翻支撑 Flip-up lift	8980311	300-650	2.8-7	1100-2250	镀镍色 + 太郎灰 Nickel electroplating in highclass grey
	8980321	350-650	4.5-10	2000-4050	

负载能力 = 门高 (mm) x 门重 (kg)



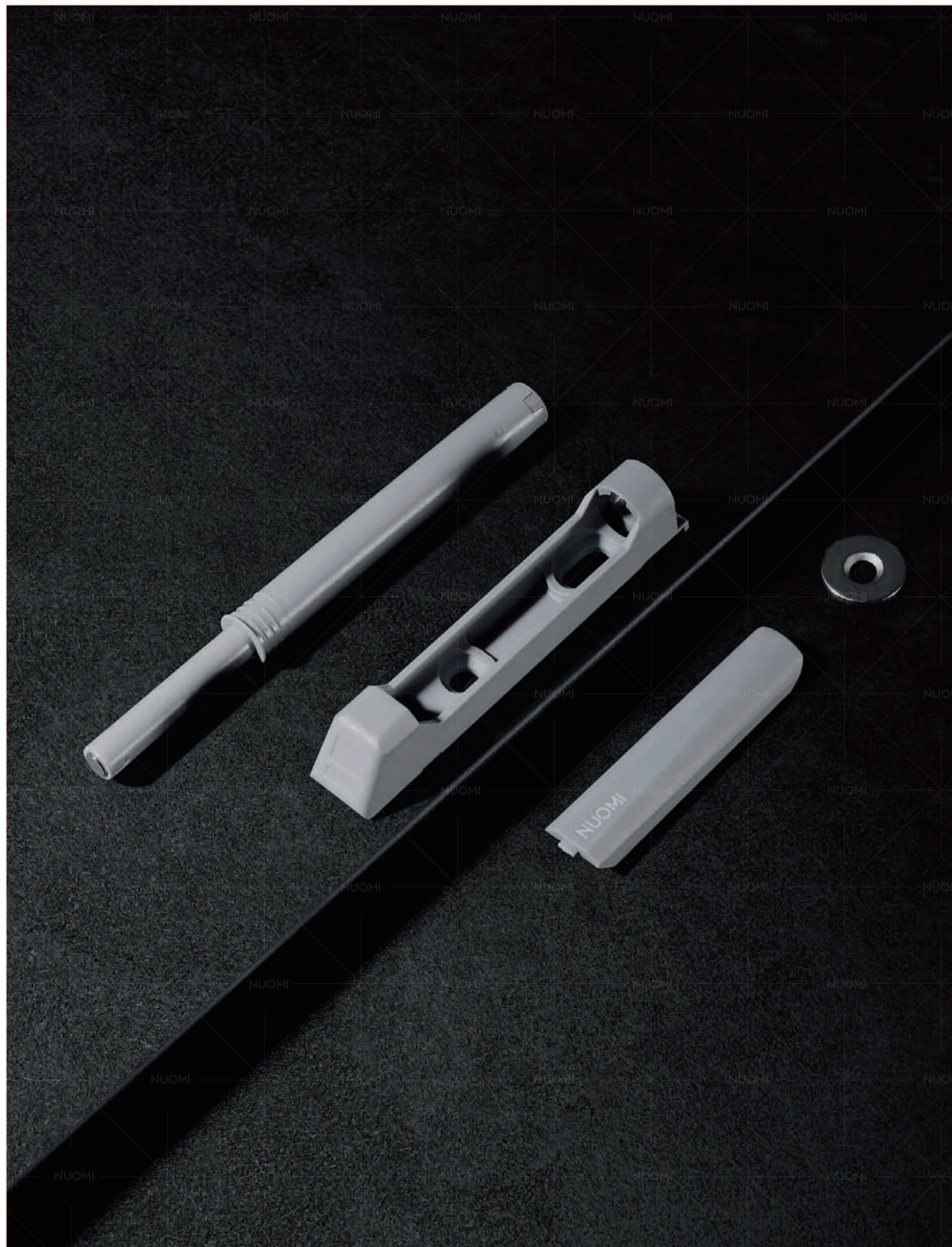

# REBOUND OPEN

反弹器

---

The space is vertically and horizontally inlaid between lines, surfaces and volumes, and the proportions are divided into and out. The stacking of elements can remove redundant and exaggerated decorative patterns. Each exquisite detail creates a comfortable and comfortable life scene.

空间由线、面、量体之间纵横镶嵌，比例分割的收放，元素之间的推砌，可去除多余的、浮夸的装饰图案，每个精致的细节营造出舒适安逸的生活场景。



REBOUND OPEN  
门板反弹器 899Q601

门板反弹力: 2-2.5KG  
可调节范围: 0-6MM  
Bounciness: 2-2.5KG  
Adjustable range: 0-6MM

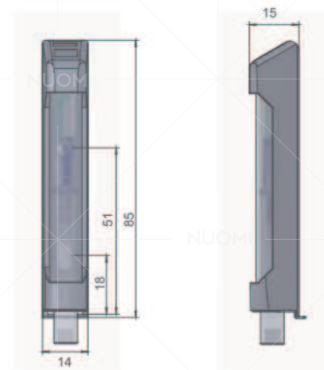

HIGH-END FURNITURE  
MOTION SOLUTIONS

诺米高端基础五金系统



NUOMI 诺米