

NUOMI 诺米

NUOMI 诺米

广东诺米家居智能科技有限公司  
GUANGDONG NUOMI HOME INTELLIGENT TECHNOLOGY CO.,LTD

广东省佛山市南海区丹灶镇金泰路3号  
Add : No.3,JinTai RD,Danzao Town,Foshan City,Guangdong Province,China  
电话Tel: 0757-86602177 (总机) 传真Fax: 0757-86602166  
服务热线Service Hotline: 400-831-7997 邮政编码Postal Code: 528000  
网址Web: www.gz-nuomi.com 邮箱E-mail: nx02@gz-nuomi.com



公众号



服务号

产品如有改动, 请以实物为准 2022年11月第一次印刷



BATHROOM  
APPLICATION SYSTEM

诺米卫浴应用系统

BATHROOM  
APPLICATION SYSTEM

卫浴应用系统

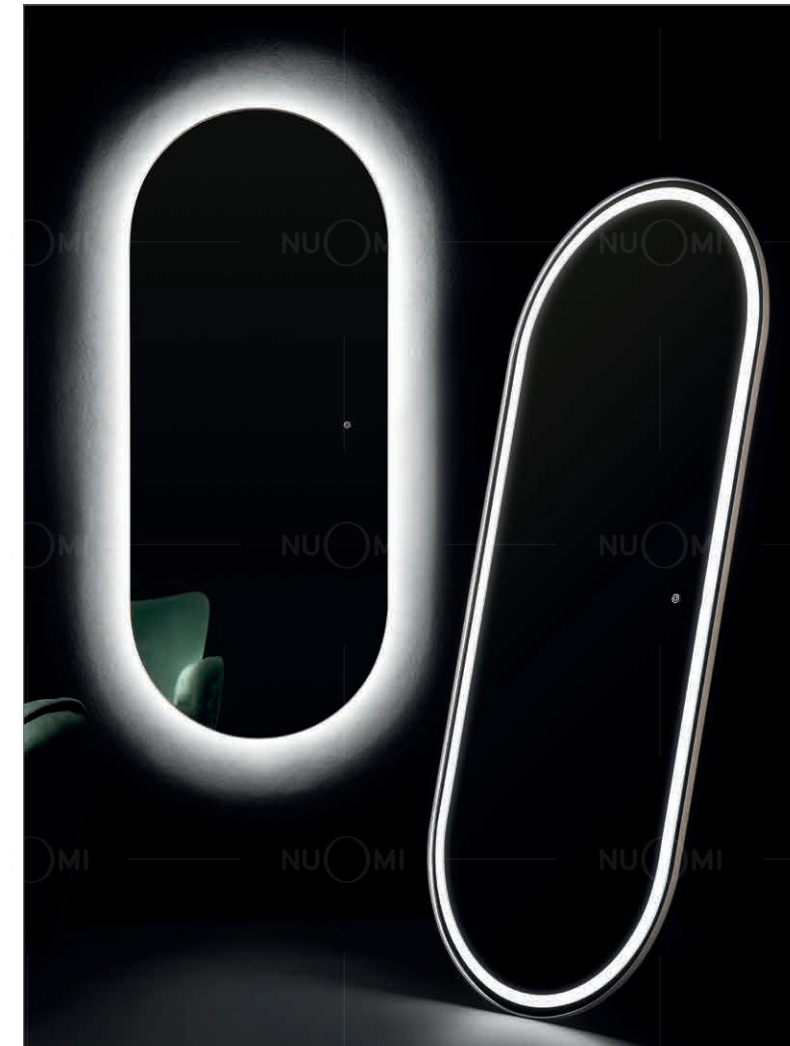

NUOMI 诺米



NUOMI IS COMMITTED TO ACHIEVE A  
PERFECT QUALITY OF LIFE!

**诺米，致力于实现完美品质生活！**

诺米作为优秀的功能五金缔造者，提供的不仅仅是产品与服务，而是对梦想生活的执着！为了赋予居家生活更加优越的功能性、舒适性和美观性。品牌将原创美学设计与智能科技完美地结合在一起，设计出独具特色的功能五金系统。为消费者打造完美品质生活。

As an excellent functional hardware creator, Nuomi not only provides products and services, but the persistence of the dream of life, in order to endow the home life with more superior functions, comfort and beauty. The brand perfectly combines the original aesthetic design with the smart technology to design an unique functional hardware system, so to create a perfect quality of life for consumers.

在诺米的世界里，创新永无止境，对品质的苛刻要求成就了诺米卓越的品牌形象。我们以安全、可靠的产品质量对顾客承担责任。坚持为顾客提供高品质产品、高标准服务，为推进品质生活的不断发展，我们一直努力前行。我们主张在顾客、员工、合作者和公司之间结成利益共同体，并力图让顾客满意、员工满意、合作者满意。

In the world of Nuomi, innovation is endless, and the demanding requirements on quality make Nuomi an excellent brand image. We are responsible to our customers with the safe and reliable product quality. We insist on providing high quality products and high standard services for our customers. In order to promote the continuous development of quality life, we have been making great efforts to move forward. We advocate a community of interests among customers, employees, partners and the company, and strive to make the customers, employees and partners satisfied.

未来，诺米将不断创新，创造更多颠覆性的设计。从设计、品质到服务，不断提升诺米的品牌价值，打造国际领军品牌。让人们在品味产品的同时更感受着来自品牌的自豪与荣耀。诺米，功能五金创新引领者，行业标准重塑者，颠覆传统生活，开创完美生活N次方时代！

In the future, Nuomi will continue to innovate and create more disruptive designs. From the design, quality to service, We will constantly enhance the brand value of Nuomi, and create an international leading brand, which enable people to feel the pride and glory from the brand while tasting the products at the same time. Nuomi, the function hardware innovation leader and the industrial standard remodeler, subvert the traditional life and create a perfect life of N times!

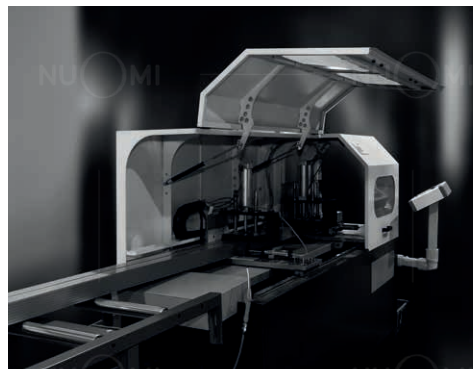
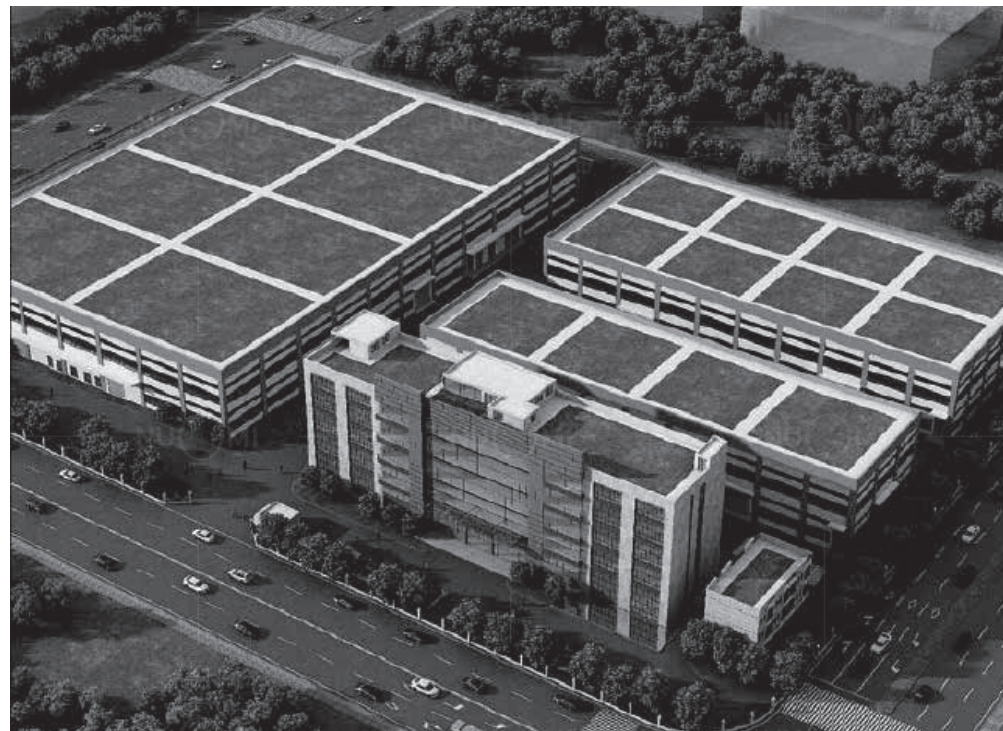
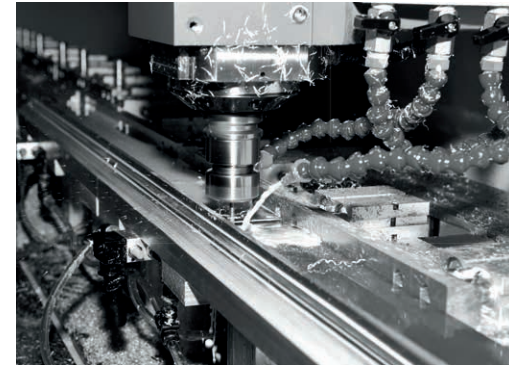
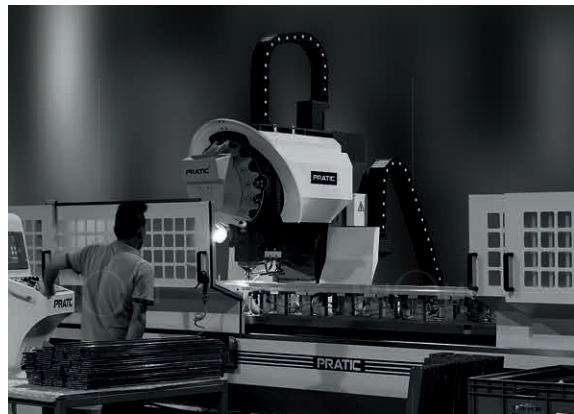

## 0.01

0.01cm 精控误差，追求卓越品质的产品契合。  
0.01Cm precision control pursue excellent quality.

## 3

3 重国际权威品质认证，英国 ISO+ 瑞士 SGS+ 德国 TÜV。  
3 international authoritative organization for quality certification:  
ISO, SGS, TÜV

## 7

7 级质检把控，从原料到成品，每一件产品历经层层检测，严控质量是诺米提供给消费者的可靠性保证。  
7 level quality control, from raw materials to finished products, each product after layers of testing, strict quality control is the reliability guarantee that NUOMI provides to consumers.

## 10

导轨 10 年至终身质量保障，让用户时刻无忧。  
Slide-10 Years quality assurance, reassure users.

## 168

纳米干镀表面处理技术，通过 168 小时盐雾测试，持久光亮不生锈。  
Dry-plating technology, pass 168 hours salt spray test, lasting bright and rust-resistant.

## 80000

导轨通过 SGS 80000 次抗疲劳运作测试，安心更舒心。  
Slide pass SGS 80000 anti-fatigue operation test, more comfortable.







INDEX - 目录

智能镜柜

## SMART MIRROR CABINET

P.011

智能镜

## SMART MIRROR

P.021

骑马抽 / 铰链 / 导轨

## DRAWER BOX/HINGES/ GUIDES

P.041

配套产品

## SUPPORTING PRODUCT

P.067

# SMART MIRROR CABINET

智能镜柜



时代发展，人们美的意识开始觉醒，通过外观与功能之间的感官结合，寻找内心生活和自我意识的真实需要。智能镜柜化身为艺术的载体、自然的链接，更加注重体验的本质。

With the development of the times, people's awareness of beauty begins to awaken, and through the sensory combination between appearance and function, they seek the real needs of inner life and self-awareness. The smart mirror cabinet is transformed into a carrier of art, a natural link, and pays more attention to the essence of experience.



NU MI

NU MI

NU MI

NU MI

NU MI

NU MI

NU MI

NU MI

NU MI

NU MI

NU MI

NU MI

NU MI

NU MI

NU MI

NU MI

NU MI

NU MI

NU MI

NU MI

NU MI

NU MI

NU MI

NU MI

NU MI

NU MI

NU MI

NU MI

NU MI

NU MI

NU MI

NU MI

NU MI

NU MI

NU MI

NU MI

NU MI

NU MI

NU MI

NU MI

NU MI

NU MI

NU MI

NU MI

NU MI

NU MI

NU MI

NU MI

NU MI

NU MI

NU MI

NU MI

NU MI

NU MI

NU MI

NU MI

NU MI

NU MI

NU MI

NU MI

NU MI

NU MI

NU MI

NU MI

NU MI

NU MI

NU MI

NU MI

NU MI

NU MI

NU MI

NU MI

NU MI

NU MI

NU MI

NU MI

NU MI









MIRROR CABINET  
智能镜柜 (单门)

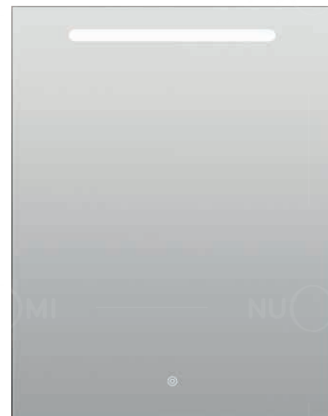

产品特点 FEATURES

- 一键触控设计、除雾功能；
  - 三色温可调、亮度可调；
  - 极简全铝合金柜体、柜体无把手设计；
  - 防爆玻璃、收纳空间更大（容积率高）；
  - 尺寸自由组合（单门 / 双门 / 三门）。
- One-button touch design, defogging function.
  - 3000K-4000K-6000K adjustable color temperature, stepless brightness adjustment.
  - Minimalist all-aluminum alloy cabinet, no handle design.
  - Explosion-proof glass, larger storage space (high volume ratio).
  - Size free combination (single door / double door / three door).

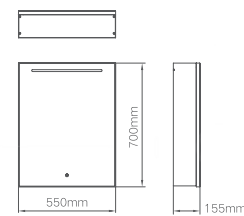

Product Name 产品名称	Item No. 型号	Specification(WxDxH) 规格 (宽 x 深 x 高) mm	Aluminium color 铝材颜色
单门	15021553	550x700x155mm	太郎灰 high-class grey

MIRROR CABINET  
智能镜柜 (双门)

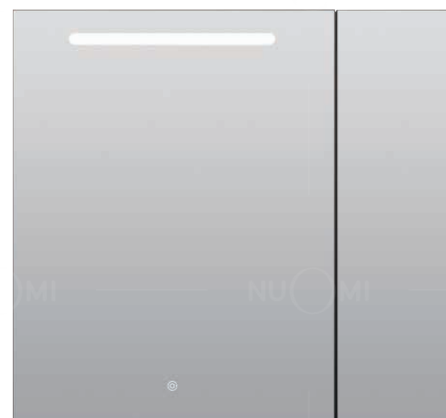

产品特点 FEATURES

- 一键触控设计、除雾功能；
  - 三色温可调、亮度可调；
  - 极简全铝合金柜体、柜体无把手设计；
  - 防爆玻璃、收纳空间更大（容积率高）；
  - 尺寸自由组合（单门 / 双门 / 三门）。
- One-button touch design, defogging function.
  - 3000K-4000K-6000K adjustable color temperature, stepless brightness adjustment.
  - Minimalist all-aluminum alloy cabinet, no handle design.
  - Explosion-proof glass, larger storage space (high volume ratio).
  - Size free combination (single door / double door / three door).

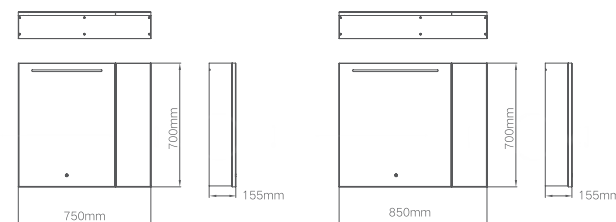

Product Name 产品名称	Item No. 型号	Specification(WxDxH) 规格 (宽 x 深 x 高) mm	Aluminium color 铝材颜色
双门	15021753	750x700x155mm	太郎灰 high-class grey
	15021853	850x700x155mm	太郎灰 high-class grey

MIRROR CABINET  
智能镜柜 (三门)



产品特点 FEATURES

- 一键触控设计、除雾功能；
  - 三色温可调、亮度可调；
  - 极简全铝合金柜体、柜体无把手设计；
  - 防爆玻璃、收纳空间更大（容积率高）；
  - 尺寸自由组合（单门 / 双门 / 三门）。
- One-button touch design, defogging function.
  - 3000K-4000K-6000K adjustable color temperature, stepless brightness adjustment.
  - Minimalist all-aluminum alloy cabinet, no handle design.
  - Explosion-proof glass, larger storage space (high volume ratio).
  - Size free combination (single door / double door / three door).

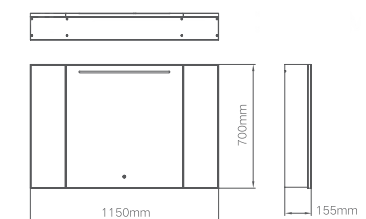
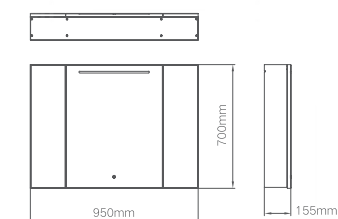

Product Name 产品名称	Item No. 型号	Specification(WxDxH) 规格 (宽 x 深 x 高) mm	Aluminium color 铝材颜色
三门	15021953	950x700x155mm	太郎灰 high-class grey
	15021113	1150x700x155mm	太郎灰 high-class grey

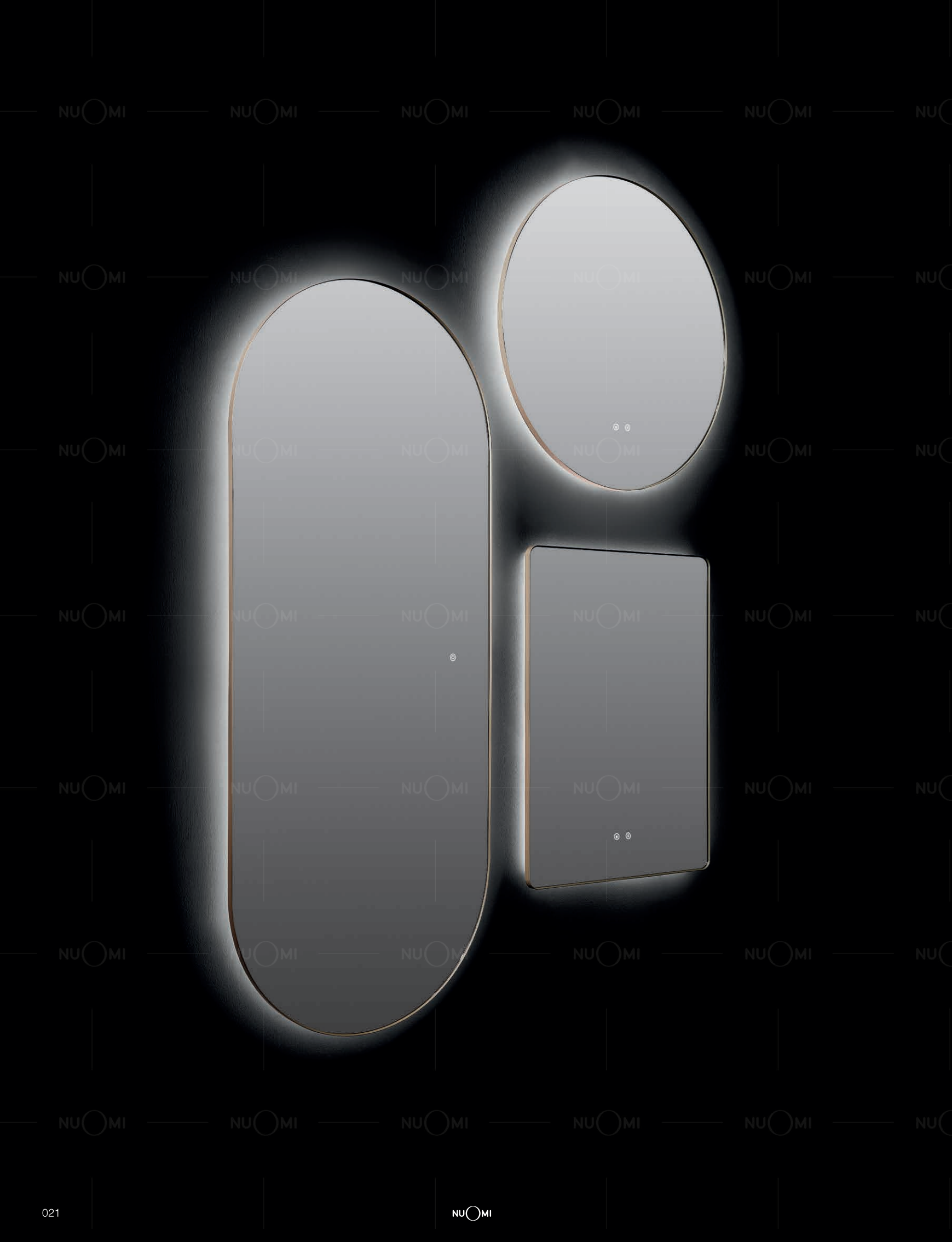

# SMART MIRROR

智能镜

---

目之所及，简而明朗的色泽，似时光荏苒后安静又内敛的沉淀之美，而风骨犹存。  
除了美学和功能之外，突破传统意义，实现对于空间“自然感”的实用性表达。

As far as the eye can see, the simple and clear color is like the beauty of quiet and restrained precipitation after the passage of time, but the character still remains. In addition to aesthetics and functions, it breaks through the traditional meaning and realizes the practical expression of the "natural feeling" of the space.





ROUND SMART MIRROR  
圆形智能镜 (正发光)

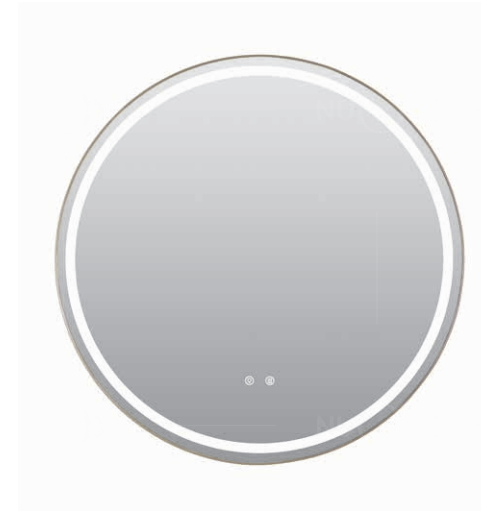

产品特点 FEATURES

- 灯光三色温 (3000K-4000K-6000K) 智能切换功能, 无级调节亮度;
- 智能一键除雾功能;
- 航空级铝合金边框。
- 3000K-4000K-6000K adjustable color temperature, stepless brightness adjustment.
- Defogging function.
- Aviation-grade aluminum alloy frame.

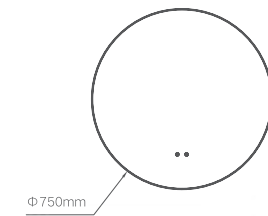

Item No. 型号	Specification 规格 mm	Aluminium color 铝材颜色	Luminous mode 发光方式
15010212	Φ750mm	香槟金 champagne gold	正发光 surface lighting
15010213	Φ750mm	太郎灰 high-class grey	正发光 surface lighting

\* 可定制尺寸

ROUND SMART MIRROR  
圆形智能镜 (背发光)



产品特点 FEATURES

- 灯光三色温 (3000K-4000K-6000K) 智能切换功能, 无级调节亮度;
- 智能一键除雾功能;
- 航空级铝合金边框。
- 3000K-4000K-6000K adjustable color temperature, stepless brightness adjustment.
- Defogging function.
- Aviation-grade aluminum alloy frame.

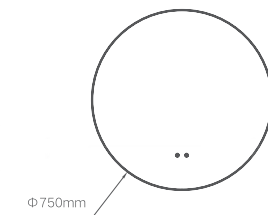

Item No. 型号	Specification 规格 mm	Aluminium color 铝材颜色	Luminous mode 发光方式
15010222	Φ750mm	香槟金 champagne gold	背发光 backlit
15010223	Φ750mm	太郎灰 high-class grey	背发光 backlit

\* 可定制尺寸







OVAL SMART MIRROR  
椭圆形智能镜 (正发光)



产品特点 FEATURES

- 灯光三色温 (3000K-4000K-6000K) 智能切换功能, 无级调节亮度;
- 智能一键除雾功能;
- 可通用横、竖安装方式;
- 航空级铝合金边框。
- 3000K-4000K-6000K adjustable color temperature, stepless brightness adjustment.
- Defogging function.
- Can be installed horizontally or vertically.
- Aviation-grade aluminum alloy frame.

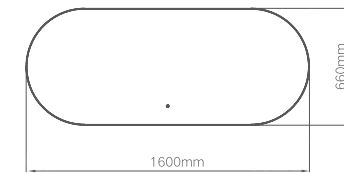

Item No. 型号	Specification(LxH) 规格 (长 x 高) mm	Aluminium color 铝材颜色	Luminous mode 发光方式
15010114	1600x660mm	香槟金 champagne gold	正发光 surface lighting
15010115	1600x660mm	太郎灰 high-class grey	正发光 surface lighting

\* 可定制尺寸

OVAL SMART MIRROR  
椭圆形智能镜 (背发光)

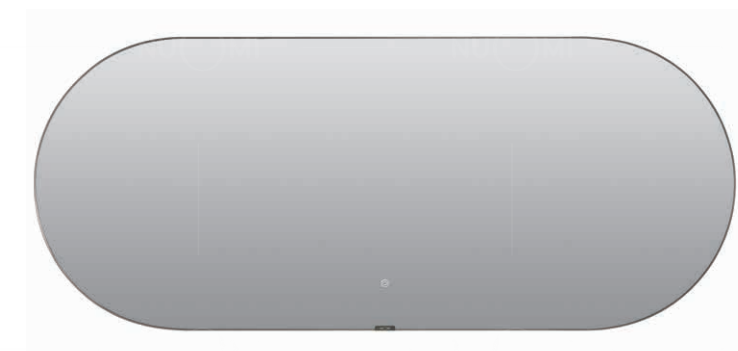

产品特点 FEATURES

- 灯光三色温 (3000K-4000K-6000K) 智能切换功能, 无级调节亮度;
- 智能一键除雾功能;
- 可通用横、竖安装方式;
- 航空级铝合金边框。
- 3000K-4000K-6000K adjustable color temperature, stepless brightness adjustment.
- Defogging function.
- Can be installed horizontally or vertically.
- Aviation-grade aluminum alloy frame.

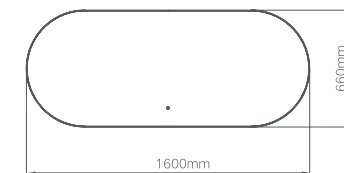

Item No. 型号	Specification(LxH) 规格 (长 x 高) mm	Aluminium color 铝材颜色	Luminous mode 发光方式
15010124	1600x660mm	香槟金 champagne gold	背发光 backlit
15010125	1600x660mm	太郎灰 high-class grey	背发光 backlit

\* 可定制尺寸





HIGH-END SQUARE SMART MIRROR  
横装高端方形智能镜 (正发光)



产品特点 FEATURES

- 灯光三色温 (3000K-4000K-6000K) 智能切换功能, 无级调节亮度;
- 智能一键除雾功能;
- 人体红外感应智能控制系统;
- 精准时间、温度自动显示
- 局部放大的化妆镜功能;
- 航空级铝合金边框。

- 3000K-4000K-6000K adjustable color temperature,stepless brightness adjustment.
- Defogging function.
- Human infrared sensor.
- Time and temperature display.
- Partial magnification makeup mirror function.
- Aviation-grade aluminum alloy frame.

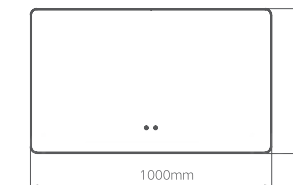

Item No. 型号	Specification(LxH) 规格 (长 x 高) mm	Aluminium color 铝材颜色	Luminous mode 发光方式
15010454	1000x600mm	香槟金 champagne gold	正发光 surface lighting
15010455	1000x600mm	太郎灰 high-class grey	正发光 surface lighting

\* 可定制尺寸

HIGH-END SQUARE SMART MIRROR  
横装高端方形智能镜 (背发光)



产品特点 FEATURES

- 灯光三色温 (3000K-4000K-6000K) 智能切换功能, 无级调节亮度;
- 智能一键除雾功能;
- 人体红外感应智能控制系统;
- 精准时间、温度自动显示
- 局部放大的化妆镜功能;
- 航空级铝合金边框。

- 3000K-4000K-6000K adjustable color temperature,stepless brightness adjustment.
- Defogging function.
- Human infrared sensor.
- Time and temperature display.
- Partial magnification makeup mirror function.
- Aviation-grade aluminum alloy frame.

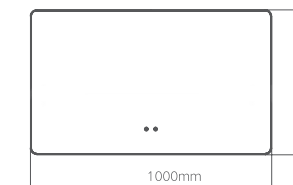

Item No. 型号	Specification(LxH) 规格 (长 x 高) mm	Aluminium color 铝材颜色	Luminous mode 发光方式
15010464	1000x600mm	香槟金 champagne gold	背发光 backlit
15010465	1000x600mm	太郎灰 high-class grey	背发光 backlit

\* 可定制尺寸



SQUARE SMART MIRROR

横装方形智能镜 (正发光)

产品特点 FEATURES

- 灯光三色温 (3000K-4000K-6000K) 智能切换功能, 无级调节亮度;
  - 智能一键除雾功能;
  - 航空级铝合金边框。
- 3000K-4000K-6000K adjustable color temperature, stepless brightness adjustment.
  - Defogging function.
  - Aviation-grade aluminum alloy frame.

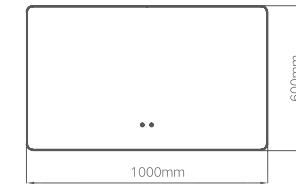
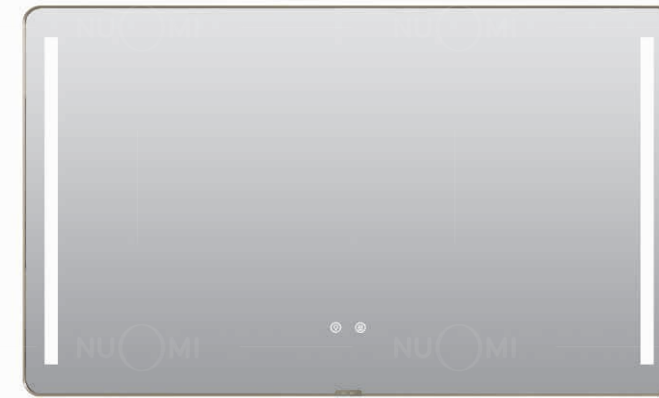

Item No. 型号	Specification(LxH) 规格 (长 x 高) mm	Aluminium color 铝材颜色	Luminous mode 发光方式
15010434	1000x600mm	香槟金 champagne gold	正发光 surface lighting
15010435	1000x600mm	太郎灰 high-class grey	正发光 surface lighting

\* 可定制尺寸

SQUARE SMART MIRROR

横装方形智能镜 (背发光)

产品特点 FEATURES

- 灯光三色温 (3000K-4000K-6000K) 智能切换功能, 无级调节亮度;
  - 智能一键除雾功能;
  - 航空级铝合金边框。
- 3000K-4000K-6000K adjustable color temperature, stepless brightness adjustment.
  - Defogging function.
  - Aviation-grade aluminum alloy frame.

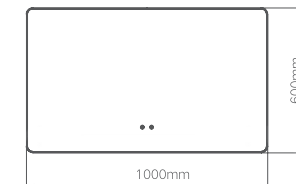
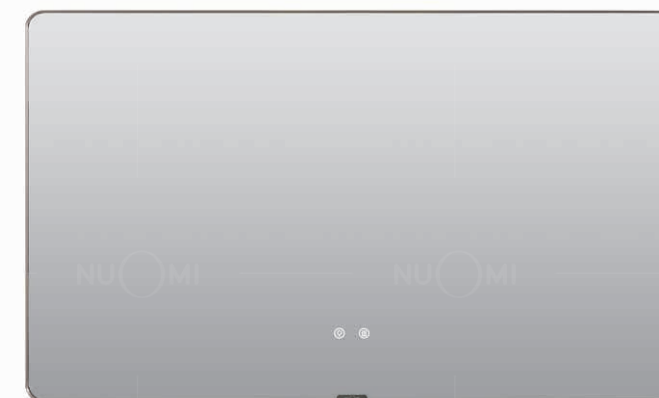

Item No. 型号	Specification(LxH) 规格 (长 x 高) mm	Aluminium color 铝材颜色	Luminous mode 发光方式
15010444	1000x600mm	香槟金 champagne gold	背发光 backlit
15010445	1000x600mm	太郎灰 high-class grey	背发光 backlit

\* 可定制尺寸







SQUARE SMART MIRROR

竖装方形智能镜 (正发光)



产品特点 FEATURES

- 灯光三色温 (3000K-4000K-6000K) 智能切换功能, 无级调节亮度;
- 智能一键除雾功能;
- 航空级铝合金边框。

- 3000K-4000K-6000K adjustable color temperature, stepless brightness adjustment.
- Defogging function.
- Aviation-grade aluminum alloy frame.

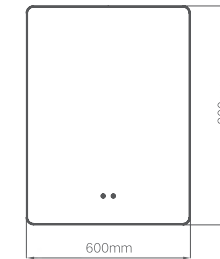

Item No. 型号	Specification(LxH) 规格 (长 x 高) mm	Aluminium color 铝材颜色	Luminous mode 发光方式
15010314	600x800mm	香槟金 champagne gold	正发光 surface lighting
15010315	600x800mm	太郎灰 high-class grey	正发光 surface lighting

\* 可定制尺寸

SQUARE SMART MIRROR

竖装方形智能镜 (背发光)



产品特点 FEATURES

- 灯光三色温 (3000K-4000K-6000K) 智能切换功能, 无级调节亮度;
- 智能一键除雾功能;
- 航空级铝合金边框。

- 3000K-4000K-6000K adjustable color temperature, stepless brightness adjustment.
- Defogging function.
- Aviation-grade aluminum alloy frame.

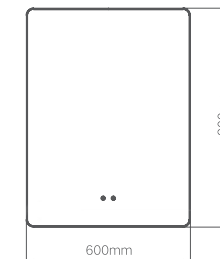

Item No. 型号	Specification(LxH) 规格 (长 x 高) mm	Aluminium color 铝材颜色	Luminous mode 发光方式
15010324	600x800mm	香槟金 champagne gold	背发光 backlit
15010325	600x800mm	太郎灰 high-class grey	背发光 backlit

\* 可定制尺寸



# DRAWER BOX/ HINGES/GUIDES

骑马抽 / 铰链 / 导轨

在化繁为简的过程中，予人生活其中而又超然物外的艺术感受。自然与艺术的对话慢慢发生，居者对生活的热爱与眷恋体现在空间之中。自然的质朴被艺术的笔触描摹、铺叙，将美学的体验放大，最终以浓淡相宜的气质，实现了令人心安的理想归处。

In the process of simplifying the complex, it gives people a sense of art in life but beyond the object. The dialogue between nature and art takes place slowly, and the residents' love and attachment to life are reflected in the space. The simplicity of nature is traced and narrated by artistic brushstrokes, amplifying the aesthetic experience, and finally achieving a reassuring ideal home with a temperament of suitable shades.







# GLASS LIGHTING DRAWER BOX

简意玻璃灯光中帮骑马抽

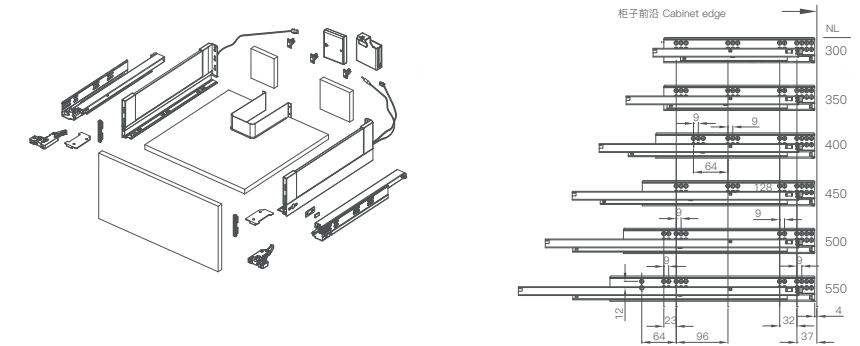

Product Name 产品名称	Item No. 型号	Nominal Length 标称长度	Physical Length 抽屉实际长度	Backboard Height 背板高度
简意玻璃灯光 中帮骑马抽 with lighting	香槟金 Champagne golden	太郎灰 Highclass grey		
	7082304	7082305	300	279
	7082354	7082355	350	329
	7082404	7082405	400	379
	7082454	7082455	450	429
	7082504	7082505	500	479
简意玻璃 中帮骑马抽 without lighting	7082554	7082555	550	529
	7082307	7082308	300	279
	7082357	7082358	350	329
	7082407	7082408	400	379
	7082457	7082458	450	429
	7082507	7082508	500	479
	7082557	7082558	550	529

## Instructions 安装说明

KB 柜体宽度 / Cabinet width  
LW 柜体净宽 / Inner cabinet width  
NL 标称长度 / Nominal length

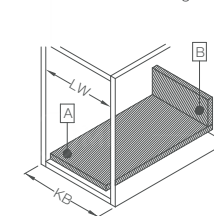

1. 箱体内部所需空间  
Space requirements in cabinet

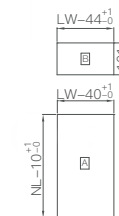

2. 用于 16/18mm 密度板的  
裁切尺寸  
Cutting dim. for 16/18mm  
chipboard

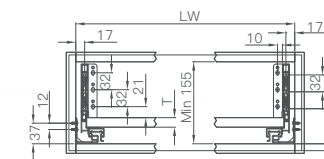

3. 箱体内部所需空间  
Space requirements in  
cabinet

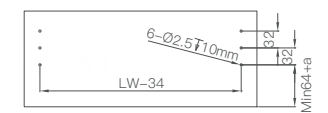

面板安装尺寸  
Back installation dimensions  
单位 unit:mm



Champagne golden 香槟金 Highclass grey 太郎灰



# GLASS LIGHTING DRAWER BOX

简意玻璃灯光高帮骑马抽

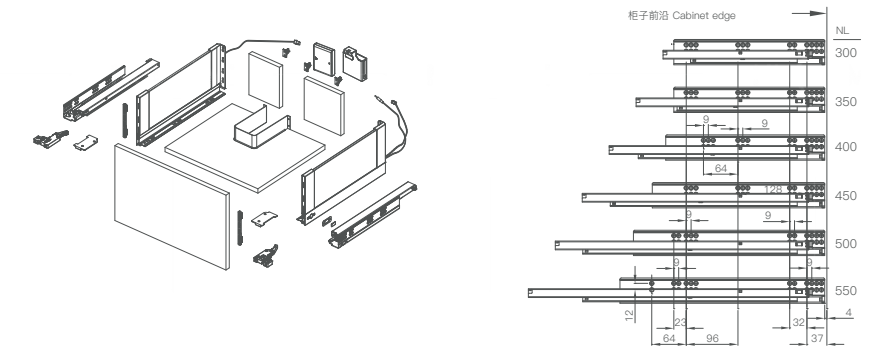

Product Name 产品名称	Item No. 型号		Nominal Length 标称长度	Physical Length 抽屉实际长度	Backboard Height 背板高度
	香槟金 Champagne golden	太郎灰 Highclass grey			
简意玻璃灯光 高帮骑马抽 with lighting	7083304	7083305	300	279	148
	7083354	7083355	350	329	148
	7083404	7083405	400	379	148
	7083454	7083455	450	429	148
	7083504	7083505	500	479	148
	7083554	7083555	550	529	148
简意玻璃 高帮骑马抽 without lighting	7083307	7083308	300	279	148
	7083357	7083358	350	329	148
	7083407	7083408	400	379	148
	7083457	7083458	450	429	148
	7083507	7083508	500	479	148
	7083557	7083558	550	529	148

## Instructions 安装说明

KB 柜体宽度 / Cabinet width  
LW 柜体净宽 / Inner cabinet width  
NL 标称长度 / Nominal length

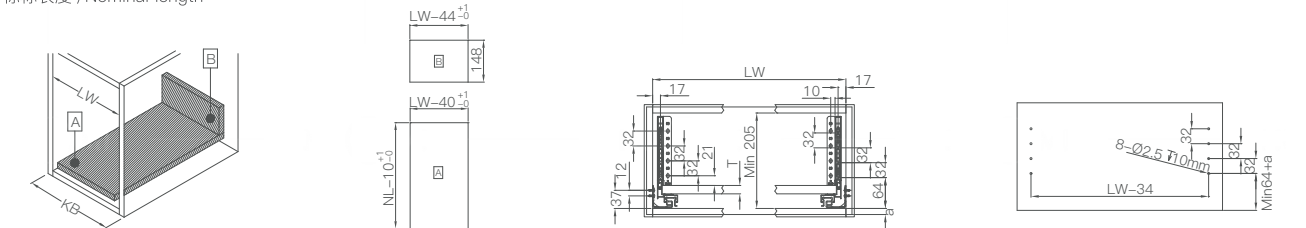

1. 箱体内部所需空间  
Space requirements in cabinet

2. 用于 16/18mm 密度板的  
裁切尺寸  
Cutting dim. for 16/18mm  
chipboard

3. 箱体内部所需空间  
Space requirements in  
cabinet

面板安装尺寸  
Back installation dimensions  
单位 unit:mm

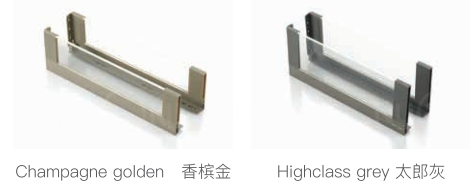



# SLIM DRAWER BOX

简意超薄中帮骑马抽

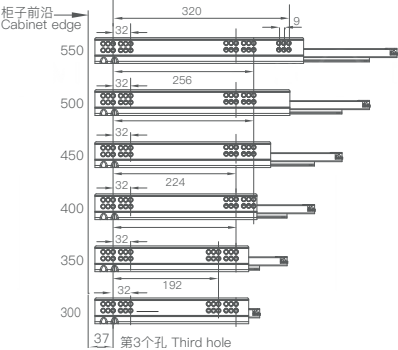
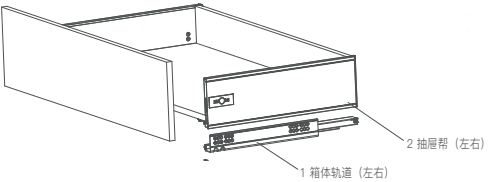
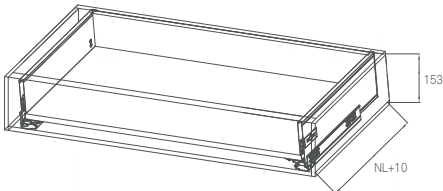

Item No. 型号	Nominal Length 标称长度	Physical Length 抽屉实际长度	Backboard Height 背板高度
香槟金 Champagne golden	太郎灰 Highclass grey		
7082301	7082302	300	290
7082351	7082352	350	340
7082401	7082402	400	390
7082451	7082452	450	440
7082501	7082502	500	490
7082551	7082552	550	540

## Instructions 安装说明

KB 柜体宽度 /Cabinet width  
LW 柜体净宽 /Inner cabinet width  
NL 标称长度 /Nominal length

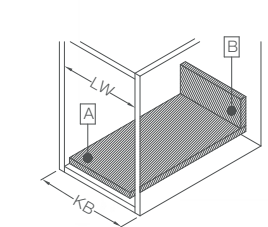

1. 箱体所需空间  
Space requirements in cabinet

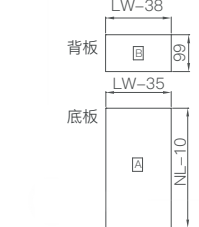

2. 用于 16/18mm 密度板的  
裁切尺寸  
Cutting dim.for 16/18mm  
chipboard

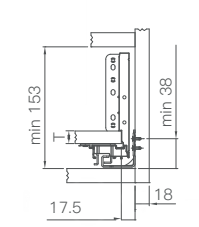

3. 箱体所需空间  
Space requirements in  
cabinet

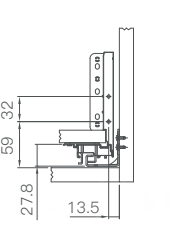

FA 面板重叠部分  
Front board overlap

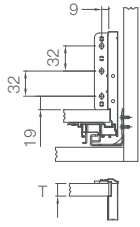

背板安装尺寸  
Back installation dimensions  
单位 unit:mm



Champagne golden 香槟金 Highclass grey 太郎灰



# SLIM DRAWER BOX

简意超薄高帮骑马抽

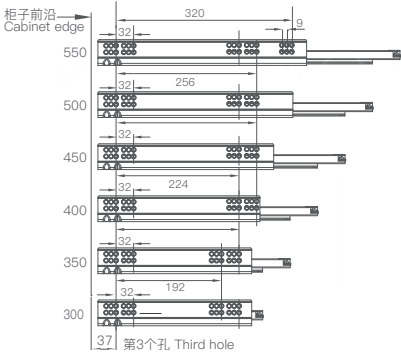
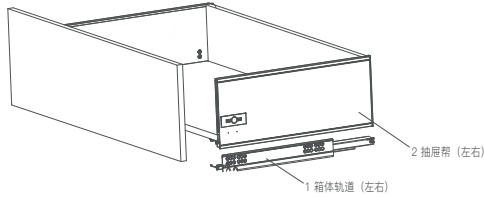
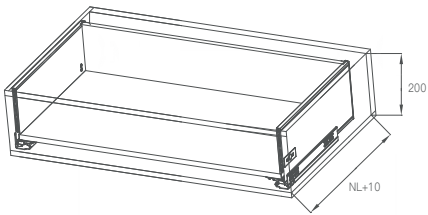

Item No. 型号	Nominal Length 标称长度	Physical Length 抽屉实际长度	Backboard Height 背板高度
香槟金 Champagne golden	太郎灰 Highclass grey		
7083301	7083302	300	290
7083351	7083352	350	340
7083401	7083402	400	390
7083451	7083452	450	440
7083501	7083502	500	490
7083551	7083552	550	540

## Instructions 安装说明

KB 柜体宽度 / Cabinet width  
LW 柜体净宽 / Inner cabinet width  
NL 标称长度 / Nominal length

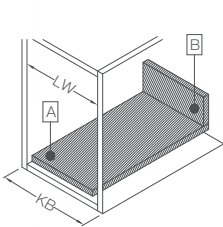

1. 箱体所需空间  
Space requirements in cabinet



2. 用于 16/18mm 密度板的  
裁切尺寸  
Cutting dim. for 16/18mm  
chipboard

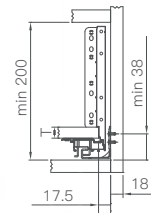

3. 箱体所需空间  
Space requirements in  
cabinet

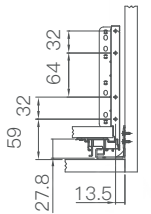

FA 面板重叠部分  
Front board overlap

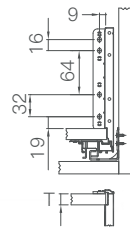

背板安装尺寸  
Back installation dimensions  
单位 unit:mm



Champagne golden 香槟金 Highclass grey 太郎灰

SEPARATOR OF DRAWER BOX  
骑马抽分隔

Description 产品名称	Item No. 型号	Specification(WxDxH) 规格	Aluminium color 铝材颜色
简意玻璃骑马抽二分隔 two-part separator	7022005	323x100x152mm	太郎灰 Highclass grey
	7022007	323x100x152mm	香槟金 Champagne golden
简意玻璃骑马抽三分隔 three-part separator	7022006	323x100x98.8mm	太郎灰 Highclass grey
	7022008	323x100x98.8mm	太郎灰 Champagne golden

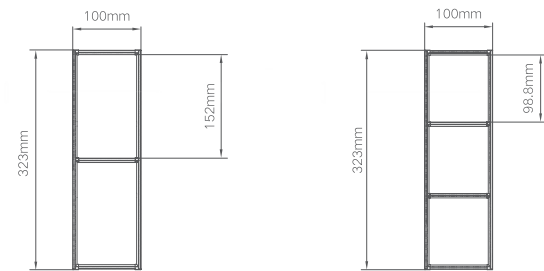
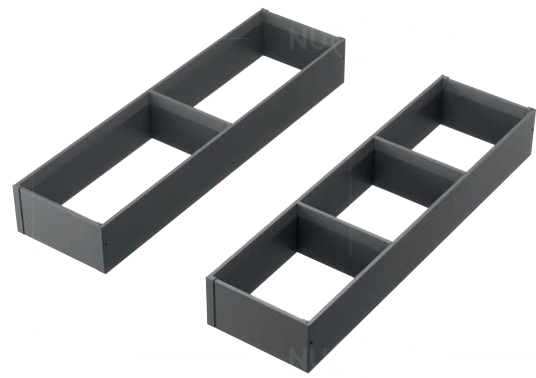

SIMPLE BACKPLANE ACCESSORIES  
FOR DRAWER BOX  
简意金属背板

Description 产品名称	Item No. 型号	L x H 长 x 高	Applicative Drawer Box 适用骑马抽
简意金属背板 for Drawer Box with glass	香槟金 Champagne golden	太郎灰 Highclass grey	
	7080311	7080312	3000x61mm 低帮骑马抽 Drawer box
	7080321	7080322	3000x99mm 中帮骑马抽 Mid-height drawer box
简意金属背板配件 for Drawer Box with glass	7080331	7080332	3000x146mm 高帮骑马抽 High drawer box
	7080311A	7080312B	/
	7080321A	7080322B	/
	7080331A	7080332B	/

\* 简意玻璃灯光骑马抽、简意玻璃骑马抽、简意超薄骑马抽通用。



香槟金  
Champagne golden

太郎灰  
Highclass grey

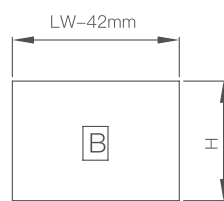

LW 柜体净宽 / Inner cabinet width  
背板减尺: 42mm

U-SHAPED ACCESSORY FOR SINK DRAIN  
U型抽屉槽

Item No. 型号	Color 颜色	Specification 规格	Material 材质
7080917	太郎灰 Highclass grey	244x155x86.4mm	铝合金 Aluminum alloy
7080918	香槟金 Champagne golden	244x155x86.4mm	铝合金 Aluminum alloy
7080919	灰色 grey	245x150x118mm	ABS

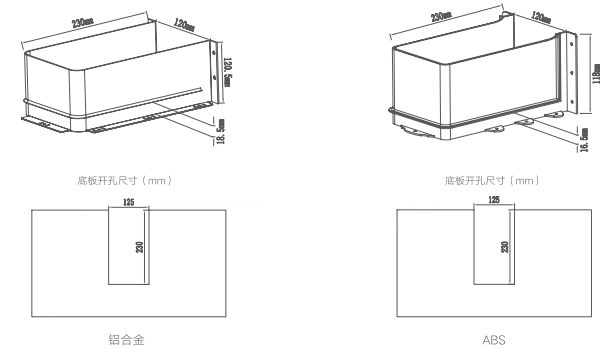

ACCESSORY FOR DRAWER BOX OF 16MM BOARD  
16mm 板配件

Description 产品名称	Item No. 型号	Applicative Drawer Box 适用骑马抽
简意玻璃灯光中帮骑马抽 16mm 板配件 Accessory for drawer box of 16mm board	7080915	中帮骑马抽 Mid-height drawer box
简意玻璃灯光高帮骑马抽 16mm 板配件 Accessory for drawer box of 16mm board	7080916	高帮骑马抽 High drawer box

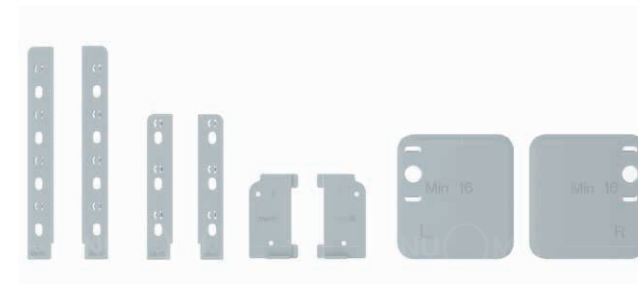

ACCESSORY FOR DRAWER BOX OF 16MM BOARD  
16mm 板配件

Description 产品名称	Item No. 型号	Applicative Drawer Box 适用骑马抽
简意中抽 16mm 板配件 Accessory for drawer box of 16mm board	7080912	中帮骑马抽 Mid-height drawer box
简意高抽 16mm 板配件 Accessory for drawer box of 16mm board	7080913	高帮骑马抽 High drawer box

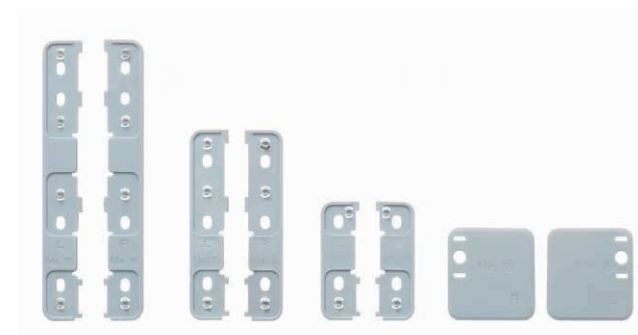

## NANO TITANIUM HINGE QUICK MOUNTED TWO SECTION FORCE

纳米钛金铰链二段力 - 超级防锈

### 产品特点 FEATURES

- 超级防锈：纳米干镀钛金表面处理技术，通过 168 小时盐雾测试；
  - 超大调节范围：±4.5mm 大范围调节，门板缝隙 < 1mm；
  - 适用多种厚度板型：门板：14-22mm，侧板：15-21mm；
  - 出色的承重能力：6 层锰钢叠片，实心胶粒，减震静音，加强承重；
  - 超强液压系统：加长油缸，油量更多，阻尼效果更出色；
  - 方线二段力弹簧：受力均匀，开合更顺畅。
- Super anti-rust: Nano-dry titanium-plating, passed 168 hours salt spray test;
  - Large adjustment range: ±4.5mm wide adjustment, door panel gap < 1mm;
  - Suitable for various thicknesses: door panel: 14-22mm, side panel: 15-21mm;
  - Excellent load-bearing capacity: 6 layers of manganese steel laminations, solid rubber particles, shock absorption and quietness, and enhanced load-bearing;
  - Super hydraulic system: lengthened oil cylinder, more oil volume;
  - Square line two-stage force spring: Uniform force, smoother opening and closing.



快装



固装

#### Full Overlay 直臂

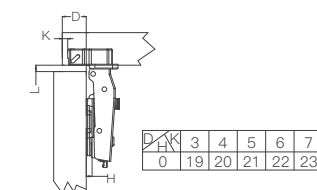

#### Hole Size 钻孔尺寸

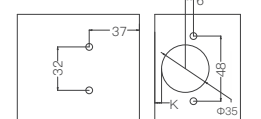

快装



固装

#### Half Overlay 中弯

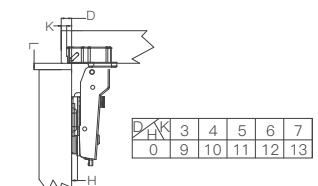

#### Hole Size 钻孔尺寸

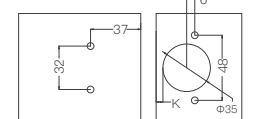

快装



固装

#### Inserted 大弯

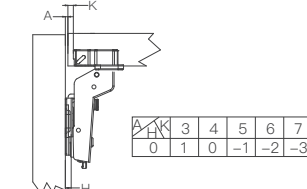

#### Hole Size 钻孔尺寸

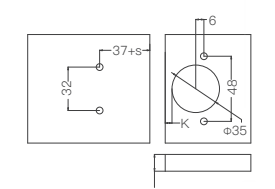

Item No. 产品型号	Overlay 盖位	Base Plate Height / Holes 底座高度 / 开孔数量	Head cup size 铰杯开孔尺寸 (直径 x 深度 ΦxH)	Opening Angle 开门角度	Surface Treatment 表面处理
快装 Fast mounted	固装 Fixed mounted				
8042011	8042001	直臂 Full Overlay H=0, 4 孔 (Holes)	Φ35x11.5mm	105°	纳米钛金 Nano Titanium
8042012	8042002	中弯 Half Overlay H=0, 4 孔 (Holes)	Φ35x11.5mm	105°	
8042013	8042003	大弯 Inserted H=0, 4 孔 (Holes)	Φ35x11.5mm	105°	



## STAINLESS STEEL HINGE FIXED MOUNTED ONE-SECTION FORCE

固装一段力 304 不锈钢铰链



## 产品特点 FEATURES

- 全不锈钢铰链：突破行业技术难题，叠片、弹簧、油缸芯全面使用不锈钢；
  - 超大调节范围：±4.5mm 大范围调节，门板缝隙 < 1mm；
  - 适用多种厚度板型：门板：14-22mm，侧板：15-21mm；
  - 出色的承重能力：6层锰钢叠片，实心胶粒，减震静音，加强承重；
  - 超强液压系统：加长油缸，油量更多，阻尼效果更出色；
  - 方线一段力弹簧：受力均匀，开合更顺畅；
  - 寿命持久耐用：欧标 50000 次开合测试。
- Completely stainless steel hinge: Break through the technical problems in the industry, lamination, spring, and cylinder core are made of stainless steel
  - Large adjustment range: ±4.5mm wide adjustment, door panel gap < 1mm;
  - Suitable for various thicknesses: door panel: 14-22mm, side panel: 15-21mm;
  - Excellent load-bearing capacity: 6 layers of manganese steel laminations, solid rubber particles, shock absorption and quietness, and enhanced load-bearing;
  - Super hydraulic system: lengthened oil cylinder, more oil volume;
  - Square line two-stage force spring: Uniform force, smoother opening and closing.
  - Long service life and durable: Pass the European standard 50000 opening and closing tests.

### Full Overlay 直臂

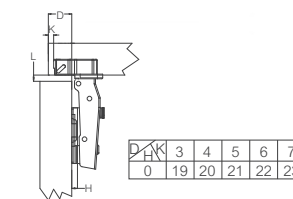

### Hole Size 钻孔尺寸

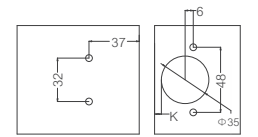

### Half Overlay 中弯

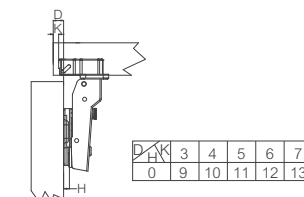

### Hole Size 钻孔尺寸

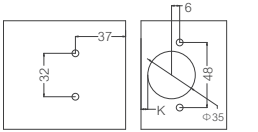

### Inserted 大弯

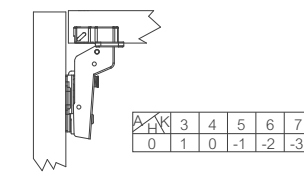

### Hole Size 钻孔尺寸

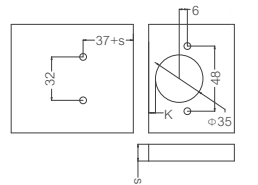

Item No. 产品型号	Overlay 盖位	Base Plate Height / Holes 底座高度 / 开孔数量	Head cup size 铰杯开孔尺寸 (直径 x 深度 ΦxD)	Opening Angle 开门角度	Surface Treatment 表面处理
8051001	直臂 Full Overlay	H=0, 4 孔 (Holes)	Φ35x11.5mm	105°	304 不锈钢 SUS304
8051002	中弯 Half Overlay	H=0, 4 孔 (Holes)	Φ35x11.5mm	105°	
8051003	大弯 Inserted	H=0, 4 孔 (Holes)	Φ35x11.5mm	105°	

FIXED MOUNTED HINGE FOR NARROW ALUMINUM FRAME  
窄铝框铰链 - 枪黑色

窄铝框铰链 - 枪黑色

产品特点 FEATURES

- 二段力结构, 缓和柜体和柜门共振;
  - 材质厚度: 1.2mm;
  - 表面工艺: 枪黑;
  - 盐雾测试: 中性 48H;
  - 适配铝框尺寸: 20MM;
  - 承重: 4-6KG。
- Two-stage force structure to ease the resonance of cabinet body and cabinet door;
  - Material thickness: 1.2mm;
  - Surface technology: gun black;
  - Salt spray test: neutral 48H;
  - Suitable for aluminum frame size: 20MM;
  - Load-bearing: 4-6KG.



Full Overlay  
直臂

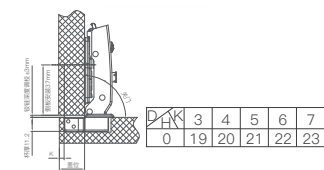

Hole Size  
钻孔尺寸

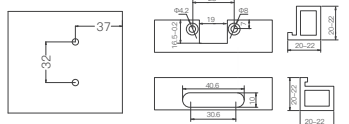

Half Overlay  
中弯

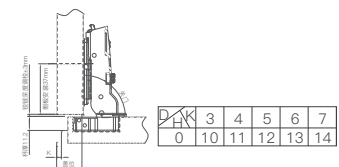

Hole Size  
钻孔尺寸

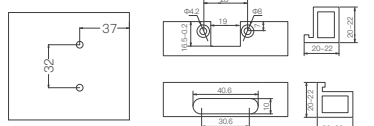

Inserted  
大弯

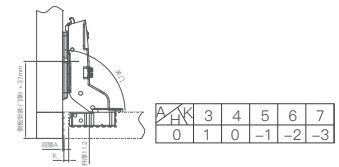

Hole Size  
钻孔尺寸

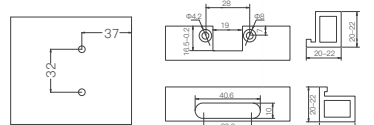

Item No. 产品型号	Overlay 盖位	Base Plate Height / Holes 底座高度 / 开孔数量	Hole Size 钻孔尺寸	Head cup size 铰杯开孔尺寸 (直径 x 深度 ΦxD)	Opening Angle 开门角度	Surface Treatment 表面处理
8122001	直臂固装 Full Overlay	H=0, 4 孔 (Holes)	28mm	Φ35x11.5mm	105°	镀镍枪黑色 Nickel Electroplating ash black
8122002	中弯固装 Half Overlay	H=0, 4 孔 (Holes)	28mm	Φ35x11.5mm	105°	
8122003	大弯固装 Inserted	H=0, 4 孔 (Holes)	28mm	Φ35x11.5mm	105°	

# MEHR CONCEALED SYNCHRONOUS DAMPING SLIDE

迈赫隐藏式同步阻尼滑轨

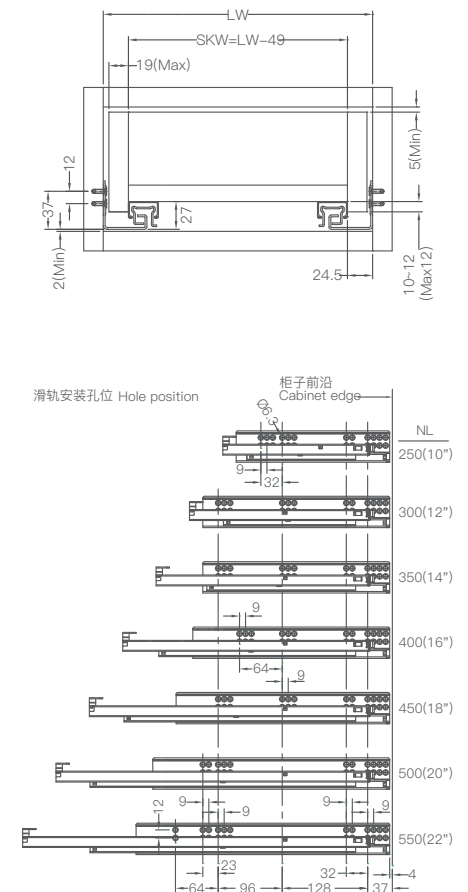
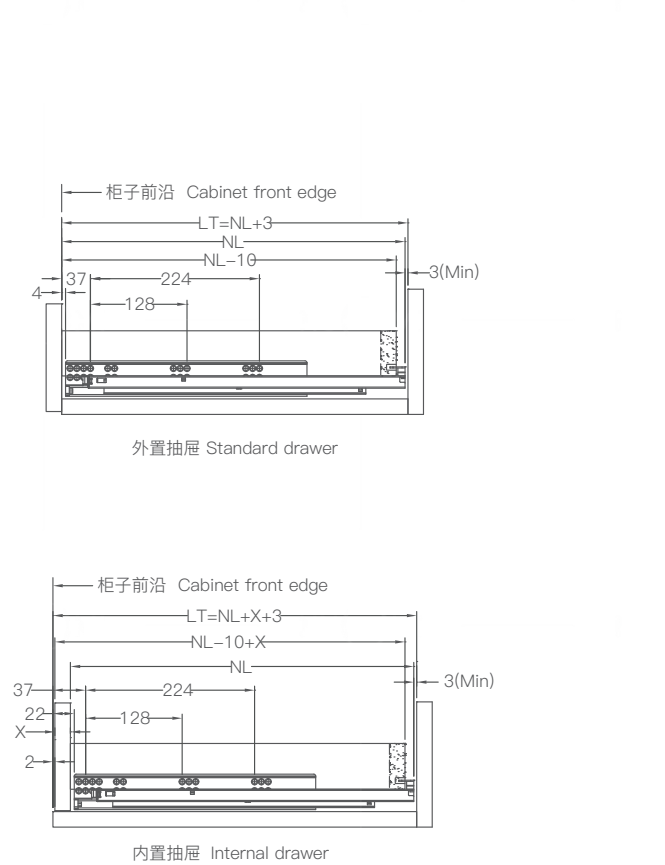

## Description 产品描述

动态负重: 30Kg(10"-22")

材质: 镀锌板

材料厚度: (上、中、下)1.0/1.5/1.8mm

带快速拆装把手, 抽屉可轻松拆卸安装

您只需轻轻地转动调节齿轮就可以轻松地调整高度

可选产品规格: 250-550mm

单位: mm

Dynamic Load: 30kg(10"-22")

Material: Galvanized Plate

Material Thickness: (upper, middle, bottom)1.0/1.5/1.8mm

with quickly mounted handle, easy to disassemble the drawer

slightly turn the adjusting gear can adjust the height easily

Optional specification: 250-550mm

Unit: mm

Description 产品名称	Item No. 产品型号	Nominal Length 标称长度	Drawer Length 抽屉长度 L-10	Min Depth 最小柜深
	7036251	250	240	265
	7036301	300	290	315
隐藏式同步阻尼滑轨 (带把手)	7036351	350	340	365
Concealed synchronous Damping slide (with handle)	7036401	400	390	415
	7036451	450	440	465
	7036501	500	490	515
	7036551	550	540	565

抽屉尺寸和钻孔(mm) Drawer size and drilling

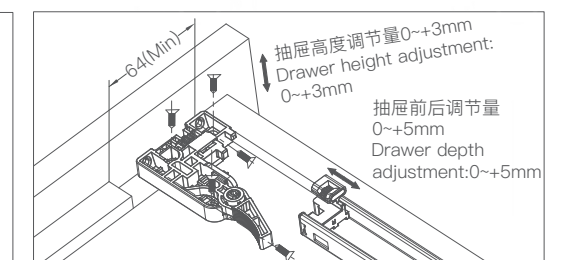
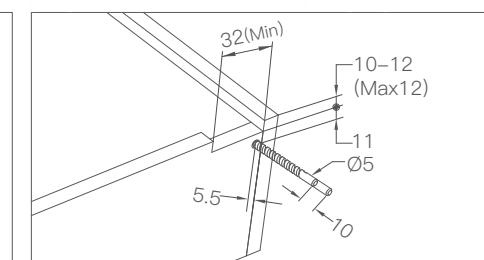
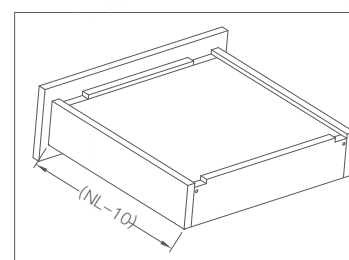

# SALLY CONCEALED SYNCHRONOUS DAMPING SLIDE

飒利隐藏式阻尼二节小全拉滑轨

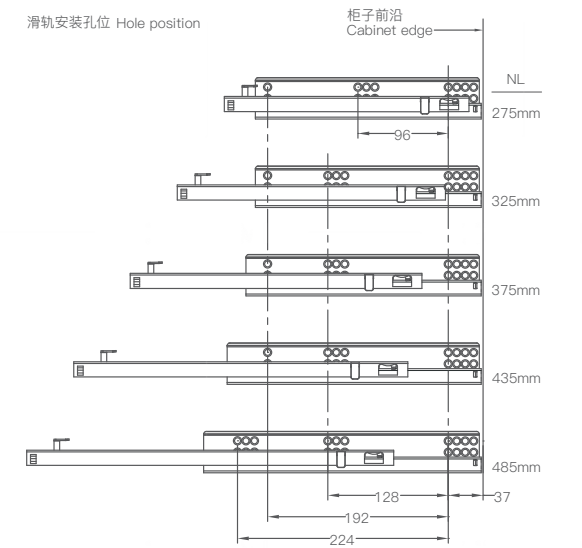
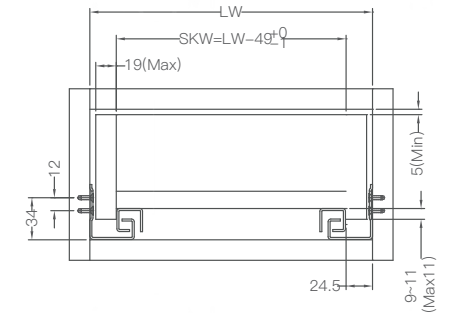
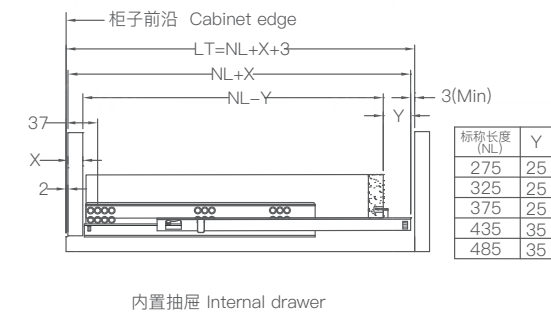
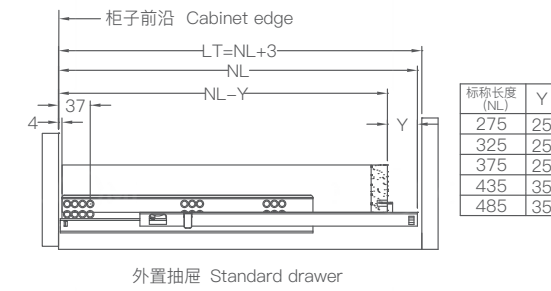

## Description 产品描述

动态负重: 25Kg  
 材质: 镀锌板  
 拉出深度: > 90%  
 抽屉高度调节量 0~+3mm  
 快速安装和拆卸, 您只需轻轻地转动调节齿轮就可以轻松地调整高度  
 可选产品规格: 250-450mm  
 单位: mm  
 Dynamic Load: 25kg  
 Material: Galvanized Plate  
 Pull out depth: > 90%  
 Drawer height adjustment 0~+3mm  
 Installed and removed quickly, slightly turn the adjusting gear can adjust the height easily  
 Optional specification: 250-450mm  
 Unit: mm

Description 产品名称	Item No. 产品型号	Nominal Length 标称长度	Min Depth 最小柜深
	7032255	275	280
隐藏式阻尼二节小全拉滑轨 (带插销)	7032305	325	330
Concealed synchronous Damping slide (with handle)	7032355	375	380
	7032405	425	440
	7032455	485	490

抽屉尺寸 Drawer size

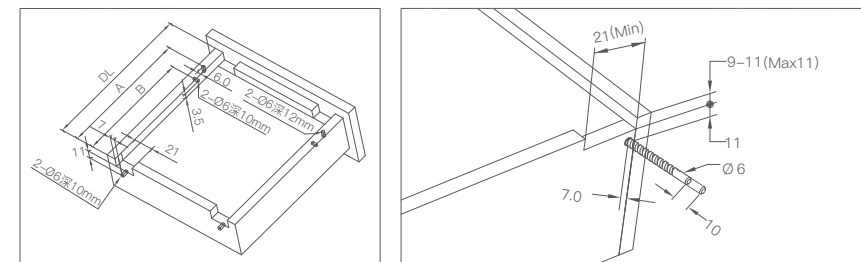

Drawer Length 抽屉长度	A	B
250mm (1.4*1.4) 10 寸	220	188
300mm (1.4*1.4) 12 寸	245	213
350mm (1.4*1.4) 14 寸	270	238
400mm (1.4*1.4) 16 寸	305	273
450mm (1.4*1.4) 18 寸	330	298



# SUPPORTING PRODUCT

配套产品

---

造型典雅而又不乏精巧，呈现出一种令人舒心的美，精雕细琢的细节让家居成为释放压力和解放心灵的净土，令人不禁放慢脚步享受浪漫的宁静生活。

Elegant yet sophisticated, it presents a comforting beauty, and the meticulously crafted details make the home a pure land to release stress and liberate the mind, making us tempting to slow down and enjoy a romantic and peaceful life.



L-SHAPED SHELF  
L 型置物架

Item No. 型号	Specification(WxDxH) 规格(宽 x 深 x 高) mm	Aluminium color 铝材颜色
15031302	116x66.5x2800mm	香槟金 champagne gold
15031303	116x66.5x2800mm	太郎灰 high-class grey

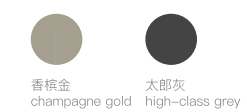
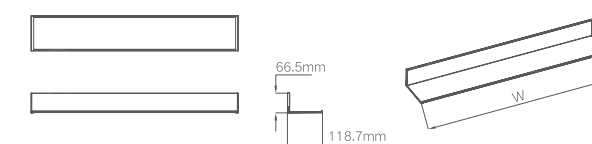

CUSTOM OPEN SHELF  
铝板开架定制

Item No. 型号	Specification(WxDxH) 规格(宽 x 深 x 高) mm	Aluminium color 铝材颜色
13025002	来图定制 customization	香槟金 champagne gold
13025003	来图定制 customization	太郎灰 high-class grey

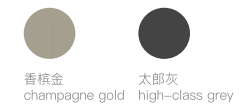

NUOMI

NUOMI

NUOMI

NUOMI

NUOMI





产品特点 FEATURES

- 采用高品质 LED 光源，可调色温（3000K、4000K、6000K）、亮度，出光均匀，54000 小时超长寿命；
- 直接固定墙面安装便捷，简约轻奢，插入式交流电 220VAC；
- 优质铝合金，承重力强，铝型材水性氟碳喷涂工艺；
- 显指 Ra>90。
- Adjustable light color temperature and brilliance, lighting balance, service life over 54000 hours.
- Easy to install, Plug-in alternating current 220VAC.
- Anodised aluminium, strong loadbearing, Aluminium profile, waterborne fluorocarbon coating technology.
- Ra>90.

可调灯源色温 COLOR TEMPERATURE ADJUSTABLE



安装说明 INSTALLATION INSTRUCTIONS

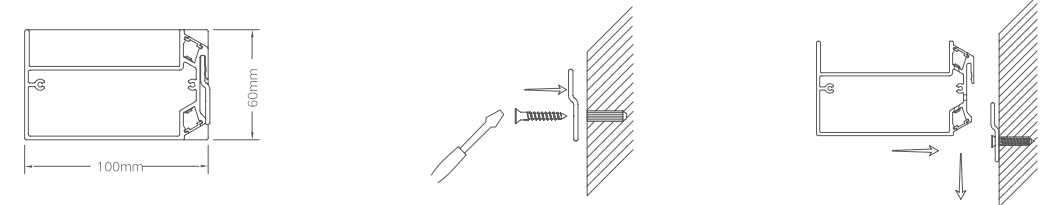

技术参数 TECHNICAL DETAILS

Color Temperature 色温 (K)	Item No. 型号	Size (mm) 尺寸 (mm)	Power 功率	Sensor switch 感应开关
可调色温 (3000K、4000K、6000K)	Champagne golden 香槟金	Highclass grey 太郎灰		
	12120062	12120063	600mm	12W
	12120092	12120093	900mm	18W
	12120122	12120123	1200mm	24W
	12120002	12120003	定制尺寸 custom size	20W/m 米

内置无线触摸调光感应开关 (内置 12V 恒压驱动电源)  
built-in wireless touch sensor switch for light adjustment  
(with 3C power source)

★ 电压：220VAC，连接方式：AC 插头线 (1.2M)。AC plug with cords (1.2M)。



## 产品特点 FEATURES

- 采用高品质 LED 光源，可调或可选色温（3000K、4000K、6000K），可调亮度，出光均匀，54000 小时超长寿命；
  - 采用无铅免焊技术，灯线分离结构；
  - 三面发光，无光点，适合安装 6-8mm 的玻璃；
  - 可用于衣柜、开放柜等后口玻璃层板，可裁切；
  - 显指 >90。
- Adjustable or Optional color temperature(3000K、4000K、6000K),Adjustable brilliance,lighting balance,service life over 54000 hours.
  - Unleaded welding-free technology detachable structure between wire and light.
  - Three sides lighting,Suitable for 6-8 mm thickness glass.
  - Applicable for layered glass of wardrobe or open cabinet, cuttable length.
  - RA>90.

## 安装说明 INSTALLATION INSTRUCTIONS

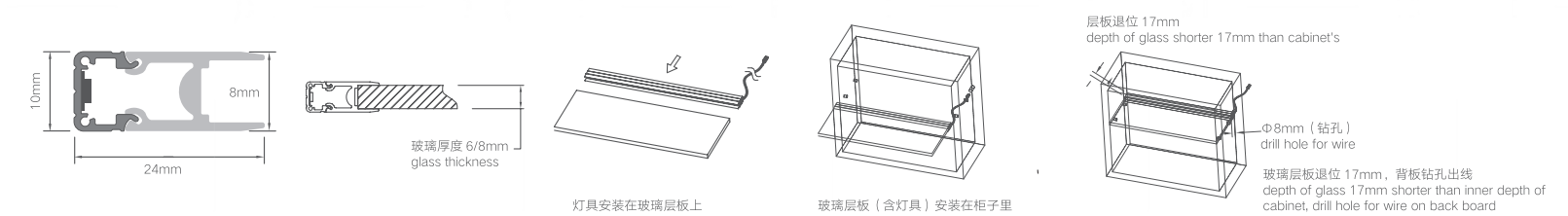

## 技术参数 TECHNICAL DETAILS

Description 产品名称	Color Temperature 色温 (K)	Item No. 型号		Size (mm) 尺寸 (mm)	Power 功率
高端灯带一灯一剪	3000K、4000K、可调三色温	12709993	太郎灰 Highclass grey	定制	/
	3000K、4000K、可调三色温	12709992	香槟金 Champagne golden	定制	/
常规灯带三灯一剪	3000K、4000K	12709993A	太郎灰 Highclass grey	定制	/
	3000K、4000K	12709992A	香槟金 Champagne golden	定制	/

★ 电压：12VDC，连接方式：诺米免焊端子线（长度 1.5M，非标配，需单独下单）。NUOMI welding-free patch cords (1.5M, additional purchase is required).



CONCEALED HANDLE FOR DUAL HINGED-DOOR TALL CABINET  
高柜双边免拉手 (带灯)

Item No. 型号	Specification(L) 规格 (长) mm	Aluminium color 铝材颜色
13041122	2500mm	香槟金 champagne gold
13041123	2500mm	太郎灰 high-class grey
13041132	2800mm	香槟金 champagne gold
13041133	2800mm	太郎灰 high-class grey

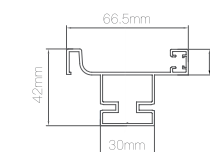

CONCEALED HANDLE FOR SINGLE-DOOR TALL CABINET  
高柜单边免拉手 (不带灯)

Item No. 型号	Specification(L) 规格 (长) mm	Aluminium color 铝材颜色
13041112	3000mm	香槟金 champagne gold
13041113	3000mm	太郎灰 high-class grey

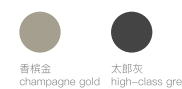
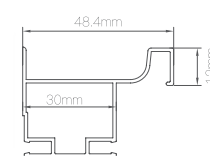

CONCEALED HANDLE FOR DUAL HINGED-DOOR TALL CABINET  
高柜双边免拉手 (不带灯)

Item No. 型号	Specification(L) 规格 (长) mm	Aluminium color 铝材颜色
13041102	3000mm	香槟金 champagne gold
13041103	3000mm	太郎灰 high-class grey

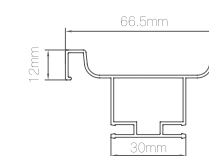

CONCEALED HANDLE FOR DUAL-OPEN BASE CABINET

中柜免拉手 (带灯)

Item No. 型号	Specification(L) 规格 (长) mm	Aluminium color 铝材颜色
13041062	3000mm	香槟金 champagne gold
13041063	3000mm	太郎灰 high-class grey

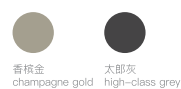
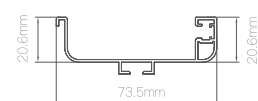

CONCEALED HANDLE FOR SINGLE-OPEN BASE CABINET

地柜免拉手 (带灯)

Item No. 型号	Specification(L) 规格 (长) mm	Aluminium color 铝材颜色
13041042	3000mm	香槟金 champagne gold
13041043	3000mm	太郎灰 high-class grey

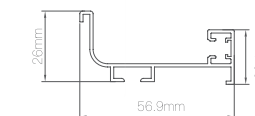

CONCEALED HANDLE FOR DUAL-OPEN BASE CABINET

中柜免拉手 (不带灯)

Item No. 型号	Specification(L) 规格 (长) mm	Aluminium color 铝材颜色
13041072	3000mm	香槟金 champagne gold
13041073	3000mm	太郎灰 high-class grey

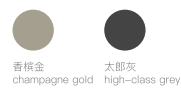
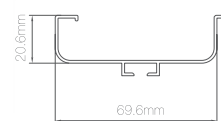

CONCEALED HANDLE FOR SINGLE-OPEN BASE CABINET

地柜免拉手 (不带灯)

Item No. 型号	Specification(L) 规格 (长) mm	Aluminium color 铝材颜色
13041052	3000mm	香槟金 champagne gold
13041053	3000mm	太郎灰 high-class grey

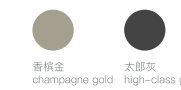
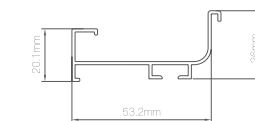

EDGE BANDING HANDLE- F TYPE

门板封边拉手 -F 型



Item No. 型号		Applicative Width 适用柜宽	Specification(L) 规格 (长) mm
香槟金 Champagne golden	太郎灰 Highclass grey		
13044012	13044013	300mm	298mm
13044022	13044023	350mm	348mm
13044032	13044033	400mm	398mm
13042012	13042013	450mm	448mm
13042022	13042023	600mm	598mm
13042032	13042033	800mm	798mm
13042042	13042043	900mm	898mm
13042052	13042053	定制尺寸 size customization	定制尺寸 size customization

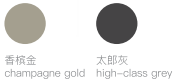
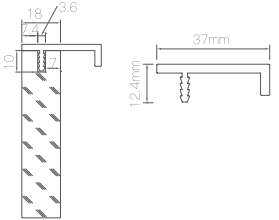

OBLIQUE EDGE BONDING HANDLE

门板封边拉手 -斜封边



Item No. 型号		Applicative Width 适用柜宽	Specification(L) 规格 (长) mm
香槟金 Champagne golden	太郎灰 Highclass grey		
13044732	13044733	300mm	298mm
13044742	13044743	350mm	348mm
13044752	13044753	400mm	398mm
13042362	13042363	450mm	448mm
13042372	13042373	600mm	598mm
13042382	13042383	800mm	798mm
13042392	13042393	900mm	898mm
13042402	13042403	定制尺寸 size customization	定制尺寸 size customization

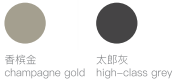
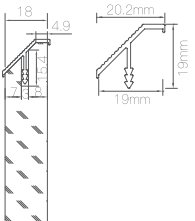



EDGE BANDING HANDLE- G TYPE  
门板封边拉手 -G 型



Item No. 型号		Applicative Width 适用柜宽	Specification(L) 规格(长) mm
香槟金 Champagne golden	太郎灰 Highclass grey		
13044092	13044093	300mm	298mm
13044102	13044103	350mm	348mm
13044112	13044113	400mm	398mm
13042062	13042063	450mm	448mm
13042072	13042073	600mm	598mm
13042082	13042083	800mm	798mm
13042092	13042093	900mm	898mm
13042102	13042103	定制尺寸 size customization	定制尺寸 size customization

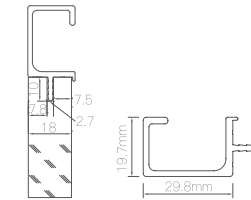

EDGE BANDING HANDLE - B  
门板封边拉手 - 字母 B



Item No. 型号		Applicative Width 适用柜宽	Specification(L) 规格(长) mm
香槟金 Champagne golden	太郎灰 Highclass grey		
13044572	13044573	300mm	298mm
13044582	13044583	350mm	348mm
13044592	13044593	400mm	398mm
13042212	13042213	450mm	448mm
13042222	13042223	600mm	598mm
13042232	13042233	800mm	798mm
13042242	13042243	900mm	898mm
13042252	13042253	定制尺寸 size customization	定制尺寸 size customization

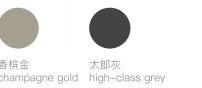
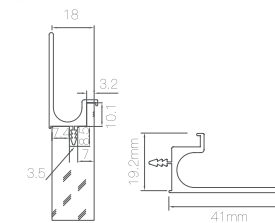

SURFACE MOUNTED HANDLE-  
BULLET STYLE

明装长短拉手 - 子弹头款式

Item No. 型号		Specification(L) 规格(长)mm	Hole qty & distance 开孔数量和孔距
香槟金 Champagne golden	太郎灰 Highclass grey		
13043062	13043063	2900mm	9孔, 孔距 320mm
13043072	13043073	2500mm	8孔, 孔距 320mm
13043082	13043083	1100mm	4孔, 孔距 320mm
13043092	13043093	220mm	2孔, 孔距 128mm
13043102	13043103	148mm	2孔, 孔距 128mm

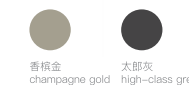
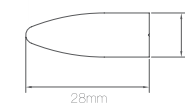







20MM NARROW FRAME GLASS DOOR-MILLING HANDLE  
20 小铝框窄边玻璃门 (铣型拉手)

Item No. 型号	Specification(WxDxH) 规格 (宽 x 深 x 高) mm	Aluminium color 铝材颜色
13053112	(W300-600)xD22x(H2800 以内定制) custom size within 2800mm	香槟金 champagne gold
13053113	(W300-600)xD22x(H2800 以内定制) custom size within 2800mm	太郎灰 high-class grey

\* 需搭配玻璃颜色下单



25MM NARROW FRAME PRIVOT-HINGED  
GLASS DOOR

25 小铝框天地铰链玻璃门

Item No. 型号	Specification(WxDxH) 规格 (宽 x 深 x 高) mm	Aluminium color 铝材颜色
13053022	(W300-600)xD25x(H2800 以内定制) custom size within 2800mm	香槟金 champagne gold
13053023	(W300-600)xD25x(H2800 以内定制) custom size within 2800mm	太郎灰 high-class grey

\* 需搭配玻璃颜色下单



20MM NARROW FRAME GLASS DOOR WITH U1 TYPE HANDLE (LEFT)  
20 子母拉手小铝框玻璃门 U1 (左)



\* 需搭配玻璃颜色下单

Item No. 型号	Specification(WxDxH) 规格(宽 x 深 x 高) mm	Aluminium color 铝材颜色
13053042	(W300-600)xD22x(H2800 以内定制) custom size within 2800mm	香槟金 champagne gold
13053043	(W300-600)xD22x(H2800 以内定制) custom size within 2800mm	太郎灰 high-class grey

\* 与 U2 款玻璃门搭配使用, 常用于对开门  
collocate with U2 type glass door, usually for dual hinged door



20MM NARROW FRAME GLASS DOOR WITH U2 TYPE HANDLE (RIGHT)  
20 子母拉手小铝框玻璃门 U2 (右)



\* 需搭配玻璃颜色下单

Item No. 型号	Specification(WxDxH) 规格(宽 x 深 x 高) mm	Aluminium color 铝材颜色
13053052	(W300-600)xD22x(H2800 以内定制) custom size within 2800mm	香槟金 champagne gold
13053053	(W300-600)xD22x(H2800 以内定制) custom size within 2800mm	太郎灰 high-class grey

\* 与 U1 款玻璃门搭配使用, 常用于对开门  
collocate with U1 type glass door, usually for dual hinged door



WITH GLASS  
搭配玻璃

Product Name 产品名称	Item No. 型号
单面油砂灰玻 Single-sided oil sand gray glass	13053501
单面油砂茶玻 Single-sided oil sand tea glass	13053502
单面油砂超白玻 Single-sided oil sand ultra-clear glass	13053503
镀膜灰玻 Coated grey glass	13053504
镀膜茶玻 Coated tea glass	13053505
镀膜超白玻 Coated ultra-clear glass	13053506
长虹超白玻 Changhong ultra-clear glass	13053507
小灯芯超白玻 Small wick ultra-clear glass	13053508
水晶格超白玻 Crystal lattice ultra-white glass	13053509
石头纹超白玻 Stone pattern ultra-white glass	13053510
超白玻 White glass	13053511
灰玻 Grey glass	13053512
茶玻 Amber-yellow glass	13053513





Focusing on the harmonious design of the golden ratio, with full color and texture, it brings people a sense of peace and stability, exuding a heart-warming elegance from the inside out. Discovering the most beautiful details in life, allowed us to realize the depth of beauty. 注重黄金比例的和谐设计，以饱满的色泽和质感，给人带来平和、稳重感，由内而外散发出令人怦然心动的典雅气韵。发现生活中最美的细节，让我们领悟到美的深度。





Focusing on the harmonious design of the golden ratio, with full color and texture, it brings people a sense of peace and stability, exuding a heart-warming elegance from the inside out. Discovering the most beautiful details in life, allowed us to realize the depth of beauty.  
 注重黄金比例的和谐设计，以饱满的色泽和质感，给人带来平和、稳重感，由内而外散发出令人怦然心动的典雅气韵。发现生活中最美的细节，让我们领悟到美的深度。



DAMPING STORAGE RATTAN BASKET  
阻尼收纳藤篮

Item No. 型号	Specification(WxDxH) 规格(宽 x 深 x 高) mm	Applicable Cabinet Width 适用柜宽
6090750	464x472x216mm	460-468
6090760	564x472x216mm	560-568

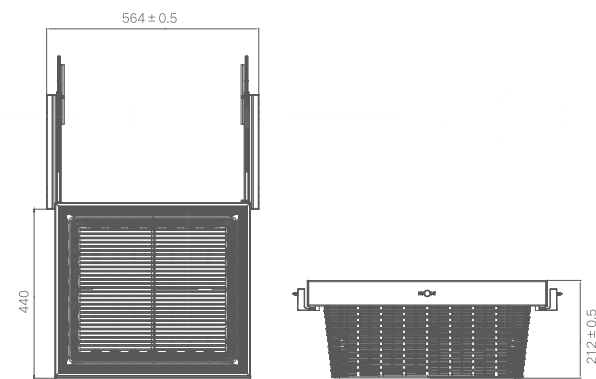

HIGH-END DAMPING LIFT HANGER  
高端阻尼升降挂衣架

Item No. 型号	Specification(WxDxH) 规格(宽 x 深 x 高) mm	Applicable Cabinet Width 适用柜宽
6091603	(564-764) x185x875mm	564-764
6091604	(764-1064) x185x875mm	764-1064

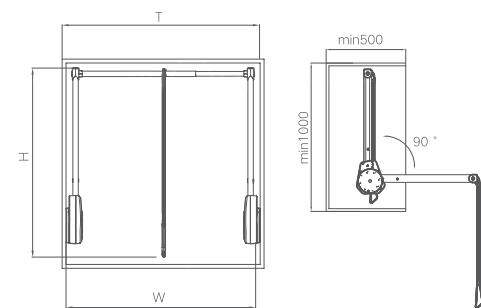

CLOTHES RAIL / RAIL BASE  
挂衣杆(方形) / 挂衣座(方形)

Item No. 型号	Specification 规格	Applicable Cabinet Width 材质
6093001	3M	塑料盖 + 锌合金 zinc alloy+plastic cover
6103001	/	塑料盖 + 锌合金 zinc alloy+plastic cover
6113001	/	塑料盖 + 锌合金 zinc alloy+plastic cover

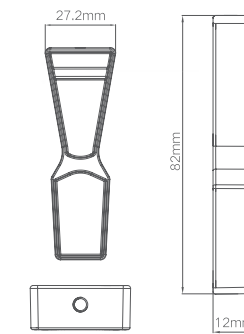

HANGING HOOK-RACK  
挂钩

Item No. 型号	Specification(WxDxH) 规格(宽 x 深 x 高) mm
15032103	284x43x56mm

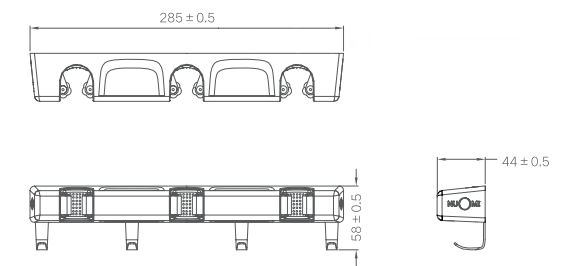

DAMPING STORAGE RATTAN BASKET  
升降机

Item No. 型号	Cabinet Width 适用柜宽 (T)	Specification 规格	Material 材质	Surface treatment 表面处理
香槟金 Champagne gold	太郎灰 Highclass grey			
4176003	4186003	600mm	564x237.6x572mm	铝合金 Aluminum alloy 氟碳喷涂 Fluorocarbon spraying
4178003	4188003	800mm	764x237.6x572mm	
4179003	4189003	900mm	864x237.6x572mm	

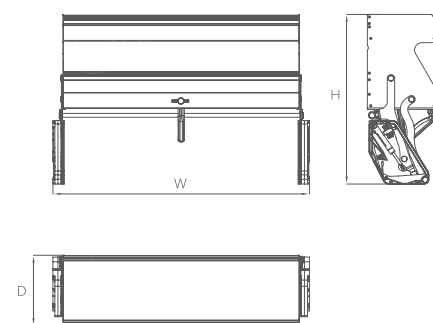

CABINET DOOR LINKAGE SINK BASKET  
柜门联动水槽篮

Item No. 型号	Cabinet Width 适用柜宽 (T)	Specification 规格	Material 材质	Surface treatment 表面处理
香槟金 Champagne gold	太郎灰 Highclass grey			
3172006	3182006	450mm	390x190x587mm	铝合金 Aluminum alloy 氟碳喷涂 Fluorocarbon spraying

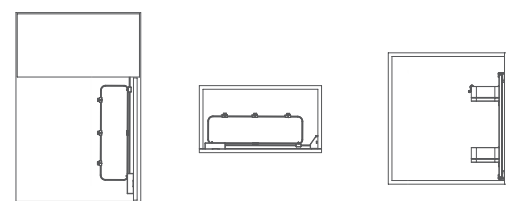

NUOMI  
BATHROOM SYSTEM

诺米卫浴系统



NUOMI 诺米