

NUOMI 诺米

NUOMI 诺米

NUOMI 诺米

广东诺米家居智能科技有限公司
GUANGDONG NUOMI HOME INTELLIGENT TECHNOLOGY CO.,LTD

地址：佛山市南海区丹灶镇丹灶物流中心金泰路3号
Add : No.3,JinTai RD,Danzao Town,Foshan City,Guangdong Province,China
电话Tel: 0757-86602177 (总机) 传真Fax: 0757-86602166
服务热线Service Hotline: 400-831-7997 邮政编码Postal Code: 528000
网址Web: www.nuomihome.com.cn 邮箱E-mail: admin@nuomihome.com



公众号



服务号

产品如有改动，请以实物为准

诺米高端智能照明系统2024



HIGH-END SMART LIGHTING SYSTEM

诺米高端智能照明系统 2024

SMART LIGHTING SOLUTION

诺米智能照明解决方案

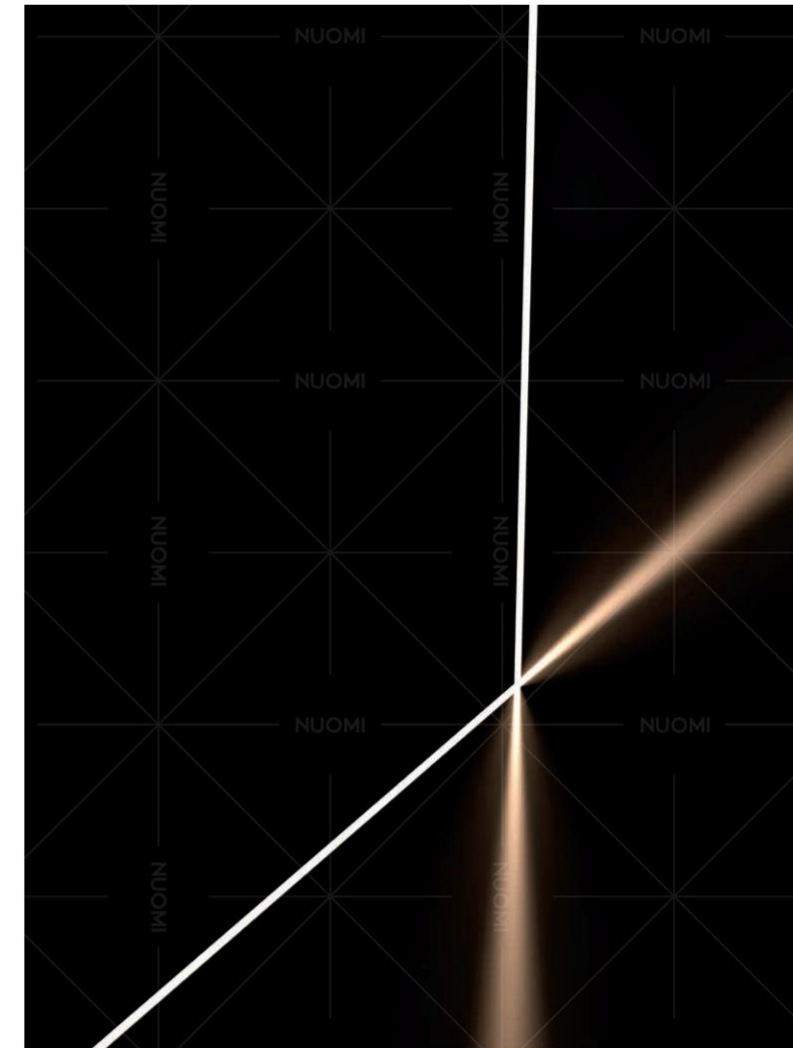

NUOMI 诺米



NUOMI ELEVATES HOME LIVING WITH ELEGANCE

诺米 · 让家居生活更有品位!

NUOMI 诺米, 成立 2003 年, 是一家集研发、设计、生产、销售于一体的高新技术企业。

NUOMI, founded in 2003 and is a high-tech enterprise that integrates research and development, design, production, and sales.

作为中国高端家居五金领军品牌之一, 诺米首创并践行「全屋五金生态链」理念, 以同风格、同颜色、同品质、同品牌的“四同法则”实现五金颜值的设计跃级, 并全面布局“橱柜功能五金、衣柜收纳五金、精工水槽、基础五金、智能照明、铝材高定应用、高端门控”七大产品体系。

As one of China's leading high-end home hardware brands, NUOMI pioneered and practices the concept of "whole-house hardware ecological chain." It uses the "four-same" concept of the same style, same color, same quality, and same brand to achieve design upgrades in hardware aesthetics and has fully laid out seven major product systems, including "kitchen storage solutions, wardrobe storage solutions, kitchen sink, furniture motion solutions, smart lighting system, high-end custom aluminum application system and high-end door lock solution."

多年发展以来, 诺米集聚全球研发智慧推出多项创新技术与五金方案, 至今拥有 250 多项创新设计专利, 产品先后通过英国皇冠 ISO9001、瑞士 SGS、德国 TÜV 等国际权威质量检测认证。凭借工业 4.0 智造转型, 诺米在行业内率先打造 80000m² (I 期) 与 63000m² (II 期) 智能生产基地, 广泛配备智能机器人、自动化设备、无人仓储系统, 用科技力量赋能五金的柔性化精密生产, 全方位提升交付实力, 并因此斩获“国家高新技术企业”“制造业全国隐形冠军”“家居智造标杆品牌”等多项荣誉。

Over the years, NUOMI has gathered global research and development intelligence and launched many innovative technologies and hardware solutions. It currently holds more than 250 innovative design invention patents and has obtained international authoritative quality certification such as the UK Crown ISO9001, Swiss SGS, and German TÜV for its products. With the transformation of Industry 4.0 intelligent manufacturing, NUOMI took the lead in building an 80,000 square meter (Phase I) and 63,000 square meter (Phase II) intelligent production base in the industry, equipped with intelligent robots, automation equipment, and unmanned storage systems. It uses technology to empower the flexible and precise production of hardware, comprehensively improving delivery capabilities and winning many honors such as "National High-tech Enterprise," "National Invisible Champion of Manufacturing Industry," and "Benchmark Brand of Home Furnishing Intelligent Manufacturing."

通过全方位的能力建构, 诺米成为行业内为数不多能提供一站式、一体化配齐方案的高端全屋五金服务商。截至目前, 面向全球市场的诺米, 现已成为全球众多橱柜品牌和家居品牌的主力供应商, 业务遍及全球 70 多个国家和地区。在中国地区, 诺米与一线上市家居品牌建立战略合作, 全国拥有 200 多个销售服务网点, 品牌实力位居行业前列。

Through comprehensive capacity building, NUOMI has become one of the few high-end whole-house hardware service providers in the industry that can provide one-stop, integrated matching solutions. As of now, NUOMI, which is facing the global market, has become a major supplier to many cabinet and wardrobe brands and home furnishing brands worldwide, with business covering more than 70 countries and regions around the world. In the Chinese market, NUOMI has established strategic cooperation with top-listed home furnishing brands, and its sales network has more than 200 dealers and agents, making it one of the leading brands in the industry.

2023 年, 诺米全新品牌形象焕新而至, 并签约唐嫣为品牌代言人, 开启品牌的跃升新程。

In 2023, NUOMI will unveil a brand new logo and brand image, and signed Tang Yan as the brand spokesperson, opening a new era of brand development.

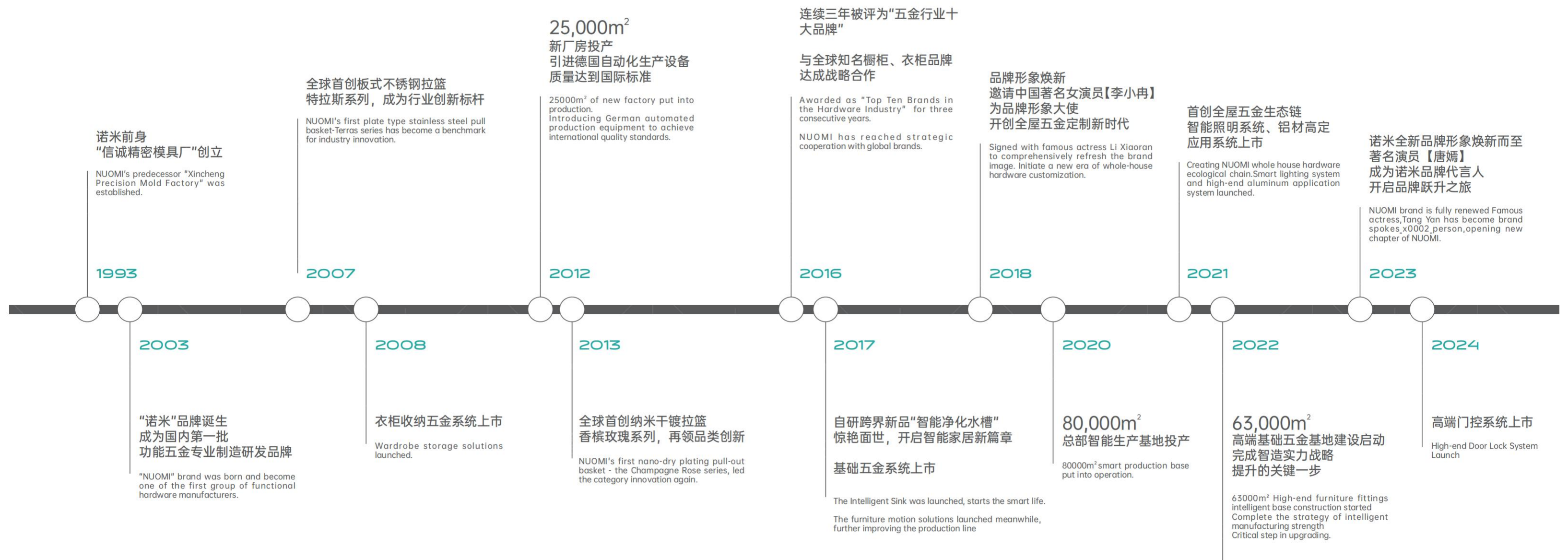

NUOMI 诺米

唐嫣
诺米全屋五金品牌代言人

「嫣」值美家
共同奔赴

诺米·全屋五金生态链

橱柜功能五金系统 KITCHEN STORAGE

衣柜收纳五金系统 WARDROBE STORAGE

精工水槽系统 KITCHEN SINK

基础五金系统 CONNECTIVE MOTION HARDWARE

智能照明系统 SMART LIGHTING

铝材高定应用系统 ALUMINUM APPLICATION

高端门控系统 HIGH-END DOOR LOCK SYSTEM

NUOMI DESIGN - 诺米设计

诺米基于极简主义“少即是多”（Less is more）的设计哲学，以全屋产品体系、至臻工艺细节、全球高阶审美，顺势推出“四同法则”，为全屋五金融入轻奢范式，满足更高阶奢居的定制所需。

NUOMI is based on the design philosophy of "Less is more", and with a complete home product system, exquisite craftsmanship details, and global high-end aesthetics, it has launched the "Four-Same" concept to integrate whole house hardware into a minimalist and luxurious paradigm, meeting the needs of high-end custom homes.

DESIGN CONCEPT

四同法则



同[风格]

极简轻奢贯穿全屋五金设计，美学风格协调统一，实现整家搭配的审美提升。

SAME STYLE

Minimalist light luxury runs through the hardware design of the whole house, coordinated aesthetic style, realize the aesthetic improvement of the whole home collocation.



同[颜色]

全屋五金不同配件保持同一色系，同色率达95%以上，满足高定家居的细节要求。

SAME COLOR

Keep the same color system for different hardware accessories in the whole house, the same color rate is over 95%, meet the detailed requirements of high-end home furnishing.



同[品质]

全屋五金由诺米4.0基地制造出厂，数智化、自动化产线高标交付，7级质检把控产品一致性。

SAME QUALITY

The whole house hardware is manufactured by NUOMI 4.0 production base, the factory is digitized and automated. The production line is delivered with high standards and 7 levels of quality inspection to control product consistency.



同[品牌]

全屋五金无需东拼西凑，诺米全系自研自产，多品类一站省心配套。

SAME BRAND

The whole house hardware does not need to be pieced together, NUOMI full system products are self-developed and self-produced, multi-category one-stop worry-free support.

全屋五金 整家奢配

Whole house hardware
the whole house is luxuriously matched.

7 大品类
7 major categories

独立研发团队“赛马”式创新
Independent R&D team with "orse racing" style innovation.

250+ 项

创新设计专利改进产品使用体验
Innovative design patents improve the user experience of the product.

3000+ 个
3000 items

产品 SKU 满足细分需求
Product SKU meet specific segmentation demands.

科技智造 双擎加速

Intelligent manufacturing with technology
dual-engine acceleration.

80000 m²

国际 4.0 数智化生产基地
International Industry 4.0 digital intelligence production base.

63000 m²

高端基础五金智造基地
The high-end furniture motion intelligent manufacturing base.

- 2014-2016 连续三年被评为“五金行业十大品牌”
- 2019 年 荣获国家级《高新技术企业证书》
- 2021 年 被全国工商联家具装饰业商会评为《中国家居优选供应链百强》《战略合作伙伴》
- 2022 年 被评为南海制造业全国隐形冠军
- 2022 年 斩获“家居智造标杆品牌”“设计创新奖”“技术领先奖”
- 2022 年 入选佛山市专精特新企业
认定为高端全屋定制五金（诺米家居）工程技术研究中心
- 2023 年 子弹头一字底座铰链荣获 2023 FDA 法国设计奖·金奖（家居五金领域唯一得主）
魅影系列拉篮荣获 2023 FDA 法国设计奖
门墙柜产业最佳一体化部品奖

Was rated as "Top Ten Brands in the Hardware Industry" for three consecutive years from 2014 to 2016
 Won the national "high-tech enterprise certificate" in 2019
 Was rated as "Top 100 Chinese Home Furnishing Supply Chain Companies" by the China Furniture & Decoration Chamber of Commerce in 2021
 Was rated as "Strategic Partner" by China Furniture & Decoration Chamber of Commerce in 2021
 Named the National Invisible Champion of Nanhai Manufacturing Industry in 2022
 Won the "Benchmark Brand of Smart Home Manufacturing", "Design Innovation Award", and "Technology Leadership Award" in 2022
 Selected as a Specialized and Innovative New Enterprise in Foshan in 2022
 Identified as Foshan High-end Customization of Whole House Hardware (Nuomi Home) Engineering Research Center in 2022
 The Bullet Series Wingless Hinge won the 2023 FDA French Design Award Golden Award (the only winner in the field of home hardware).
 The Encanto Series Pull-Out Basket won the 2023 FDA French Design Award.
 Best Product System of Door Wall Cabinets



诺米智能生产基地 II 期
NUOMI intelligent production base phase II



尖端 CNC 精密加工中心
Cutting-edge CNC precision machining center



激光切割自动化产线
Laser cutting automatic production line



诺米智能生产基地
NUOMI Intelligent Production Base



智能无人立体仓库
Intelligent unmanned three-dimensional warehouse



全自动焊接机械臂
Fully automatic welding robot arm

0.01

0.01cm 精控误差，追求卓越品质的产品契合。
0.01Cm precision control pursue excellent quality.

3

3 重国际权威品质认证，英国 ISO+ 瑞士 SGS+ 德国 TÜV。
3 international authoritative organization for quality certification:
ISO, SGS, TÜV

7

7 级质检把控，从原料到成品，每一件产品历经层层检测，严控质量是诺米提供给消费者的可靠性保证。
7 level quality control, from raw materials to finished products, each product after layers of testing, strict quality control is the reliability guarantee that NUOMI provides to consumers.

10

导轨 10 年至终身质量保障，让用户时刻无忧。
Slide-10 Years quality assurance, reassure users.

168

纳米干镀表面处理技术，通过 168 小时盐雾测试，持久光亮不生锈。
Dry-plating technology, pass 168 hours salt spray test, lasting bright and rust-resistant.

80000

导轨通过 SGS 80000 次抗疲劳运作测试，安心更舒心。
Slide pass SGS 80000 anti-fatigue operation test, more comfortable.



高新技术企业证书
Hi-tech Corporate Certificate



获英国皇冠 ISO9001 质量管理认证
ISO9001 Quality Management System Certification



德国 TÜV 质量检测认证
Quality Testing Certification



瑞士 SGS 质量检测认证
Quality Testing Certification





INDEX - 目录

宙斯系列

ZEUS LIGHT

P.019

洛克斯系列

ROCKS LIGHT

P.053

阿瑞斯系列

ARES LIGHT

P.079

感应式灯光系列

INDUCTIVE LIGHT

P.091

常规灯光系列

COMMON LIGHT

P.103

智能控制系统及配件

SMART CONTROL SYSTEM

P.111

灯光创意定制系列

LIGHT CREATIVE CUSTOMIZATION

P.129



ZEUS LIGHT

宙斯系列

It comes with a soft filter effect to create a sense of intimacy and form an active atmosphere. With the adjustment of low light, the sense of warmth slowly rises, and the space becomes full and beautiful.

自带柔和的滤镜效果，塑造亲和感，形成活跃的氛围调动，微光的调和下，温馨感缓缓而升，空间变得饱满而美妙。

GOOD CHIP SHAPES STAR LIGHT EFFECT
好芯片塑造星级光效

FULL-TINNING PROCESS THROUGHOUT,
ELIMINATING CONTACT OXIDATION
全盘满锡工艺，杜绝触点氧化

- 导电轨道全盘满锡工艺，杜绝氧化，安全放心
- 72h 盐雾测试，抗氧化耐高温
- Fully tinned conductive tracks to prevent oxidation, ensuring safety and peace of mind
- 72-hour salt spray test for oxidation and high-temperature resistance 72hours

72 hours

NUOMI

显色指数
 $\geq 90Ra$

COLOR RENDERING INDEX $\geq 90RA$
STRICTLY SELECTED WAFER CHIPS, SOFT AND UNIFORM LIGHT EFFECT

严选晶元芯片，光效柔和均匀



耀眼出色，不止一种
百搭空间设计，营造多样氛围

TEN CORE SELLING POINTS 十大核心卖点



升级密集发光芯片设计
UPGRADE DENSE LIGHT-EMITTING
CHIP DESIGN

- 300 颗密集发光芯片升级设计，灯光饱和度高，180°出光角，出光均匀整灯无暗区无点光；
- 好芯片塑造星级光效，严选晶元芯片，光效柔和均匀，显色指数 ≥ 90Ra，高度还原被照物体本色，有效减少色差。
- Upgraded design of 300 dense light-emitting chips, high light saturation, 180° light angle, uniform light output, no dark areas and no spots;
- Good chips create star light effects, carefully selected epistar chips, soft and uniform light effects, color rendering index ≥90Ra, highly restore the original color of the illuminated object, and effectively reduce color difference.



低蓝光伤害
LOW BLUE LIGHT DAMAGE

- 无频闪光学设计，如自然光般细腻柔和，呵护你和家人的清晰视界。
- The frequency-free optical design is as delicate and soft as natural light, protecting the clear vision of you and your family.



诺米独家专利免焊技术
NUOMI'S EXCLUSIVE PATENTED
WELDING-FREE TECHNOLOGY

- 升级 U 型 AB 线镀金触点与全锡焊盘精准对接，仿拉锁定设置，弹性好适用性更强，插头稳定不松脱；
- 隐藏式防拉锁定设置，线材拉力达 2.5N；
- 加长锁定弹片，插拔更方便，锁定更容易；
- 采用德国巴斯夫材料，适用性更广、稳定性更高。
- Upgraded U-shaped AB wire gold-plated contacts are precisely docked with all-tin pads, imitation pull lock settings, good elasticity and stronger applicability, and the plug is stable and not loose;
- Hidden anti-pull lock setting, wire tension up to 2.5N;
- Lengthened locking shrapnel, more convenient to plug in and pull out, easier to lock;
- Using German BASF materials, wider applicability and higher stability.



**高精密度喷锡电镀板
(灯带里导线条)**
HIGH-PRECISION TIN-SPRAYED
ELECTROPLATING BOARD
(WIRE STRIP IN THE LIGHT STRIP)

- 高精密度电路板，采用全盘满锡工艺，通过 72h 盐雾测试，抗氧化耐高温，寿命长。
- High-precision circuit board, using the technology of full tin, passed the 72h salt spray test, resistant to oxidation and high temperature, long lifespan.



同一端子应用多种型材
MULTIPLE PROFILES FOR THE
SAME TERMINAL

- 践行诺米全屋五金同色理念，免焊同色堵头不露白；
- 同一端子适用多种型材，满足各种家居装饰风格。
- Be consistent of NUOMI's concept of keeping whole-house hardware in the same color;
- The same terminal is suitable for a variety of profiles to meet various home decoration styles.



灵活裁剪随心定制
FLEXIBLE CUTTING AND
CUSTOMIZATION

- 导电轨道灵活裁剪个性定制，用户可根据空间使用需求自行裁剪；
- 让发光不再受限制，导电轨道全喷无铅锡工艺，杜绝氧化，安全放心。
- The conductive track can be flexibly cut and customized, and users can cut it according to the needs of space use.
- The light is no longer limited, the conductive track is fully sprayed with lead-free tin technology, to prevent oxidation, to be safer.



耀眼出色，不止一种
DAZZLING, MORE THAN ONE

- 3000k / 3500k / 4000k 三种光色可选，百搭空间设计，营造多样氛围；
- 暖黄光 - 打造温馨居室，自然光 - 增添几分精致感。
- 3000k / 3500k / 4000k three light colors are optional, versatile space design, creating a variety of atmospheres;
- Warm yellow light - to create a warm living room, natural light - to add a sense of sophistication.



多模态电源控制系统
MULTIMODAL POWER CONTROL
SYSTEM

- 本品可结合不同的应用场景，搭配合理的控制方案：手扫 | 门控 | 红外线 | 语音
- 12V 安全低压国际安全标准，防触电设计，安全省心
- This product can be combined with different application scenarios, with a reasonable control scheme: hand scan | door control | infrared | voice;
- 12V safe low-voltage international safety standard, anti-shock design, safe and reassuring.



卡扣式快装快拆结构
BUCKLE TYPE QUICK
INSTALLATION AND QUICK
RELEASE STRUCTURE

- 卡扣式快装快拆结构，解决繁琐安装痛点，稳固牢靠经久耐用。
- The snap-on quick-installation and quick-disassembly structure solves the pain points of cumbersome installation, and is stable, reliable and durable.



3 米半成品出货
3 METERS OF SEMI-FINISHED
PRODUCTS SHIPPED

- 灯带、型材、PC 面罩组装半成品出货，操作更简单，效率更高。
- Light strips, profiles, and PC lampshade are assembled and shipped as semi-finished products, which is easier to operate and more efficient



产品特点 FEATURES

- 升级密集发光芯片设计，可调或可选色温（3000K、3500K、4000K）柔和细腻流光，无频闪不伤眼；
- 插入式灯线分离技术，隐藏式防拉锁定设置，适用性更广、稳定性更高；
- 高精度电路板，全盘满锡工艺，抗氧化耐高温，寿命长；
- 灵活裁剪随心定制，导电轨道全喷无铅锡工艺，杜绝氧化；
- 卡扣式快装快拆结构，操作更简单，效率更高。
- Upgraded dense light-emitting chips, adjustable or optional color temperature (3000K, 3500k, 4000K), uniform illumination, lifespan over 54000 hours.
- Unleaded welding-free technology and detachable structure.
- High-density circuit board with full-tinning process for oxidation and high-temperature resistance.
- Flexible cutting, with lead-free tin spraying process on conductive tracks to prevent oxidation.
- Snap-on easy installation structure.

可选灯源色温 ADJUSTABLE COLOR TEMPERATURE

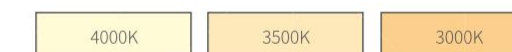

安装说明 INSTALLATION INSTRUCTIONS



技术参数 TECHNICAL DETAILS

Color Temperature 色温 (K)	Item No. 型号	Highclass grey 太郎灰	Highclass grey 波尔多红 (定制)	Highclass grey 香槟金 (定制)	Size (mm) 尺寸 (mm)	Cutout Size(WXDmm) 开槽尺寸 (WXDmm)	Remark 备注
3000K	12813003	12813001	12813002	3000MM	8x10mm	/	
3500K	12815003	12815001	12815002	3000MM	8x10mm	/	
4000K	12814003	12814001	12814002	3000MM	8x10mm	/	
堵头 end cap	12810003A	12810001A	12810002A	PC 材质	/	/	
免焊堵头 welding-free end cap	12810003B	12810001B	12810002B	PC 材质	/	/	
堵头配件包 end cap accessory pack	12810003C	12810001C	12810002C	PC 材质	/	1对堵头, 1对卡扣 a pair of end cap, a pair of buckle	

光效图 LUMINOUS EFFECT DIAGRAM

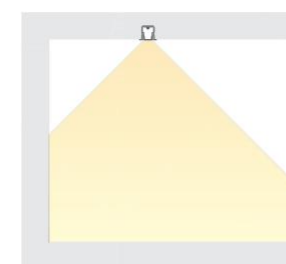

★ 电压: 12VDC, 连接方式: 诺米免焊端子线 (长度 1.5M, 非标配, 需单独下单)。NUOMI welding-free patch cords (1.5M, non-standard configuration, requires separate ordering).



产品特点 FEATURES

- 升级密集发光芯片设计, 可调或可选色温 (3000K、3500K、4000K) 柔和细腻流光, 无频闪不伤眼;
- 插入式灯线分离技术, 隐藏式防拉锁定设置, 适用性更广、稳定性更高;
- 高精度电路板, 全盘满锡工艺, 抗氧化耐高温, 寿命长;
- 灵活裁剪随心定制, 导电轨道全喷无铅锡工艺, 杜绝氧化;
- 卡扣式快装快拆结构, 操作更简单, 效率更高。
- Upgraded dense light-emitting chips, adjustable or optional color temperature (3000K、3500k、4000K), uniform illumination, lifespan over 54000 hours.
- Unleaded welding-free technology and detachable structure.
- High-density circuit board with full-tinning process for oxidation and high-temperature resistance.
- Flexible cutting, with lead-free tin spraying process on conductive tracks to prevent oxidation.
- Snap-on easy installation structure.

可选灯源色温 ADJUSTABLE COLOR TEMPERATURE

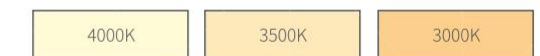

安装说明 INSTALLATION INSTRUCTIONS

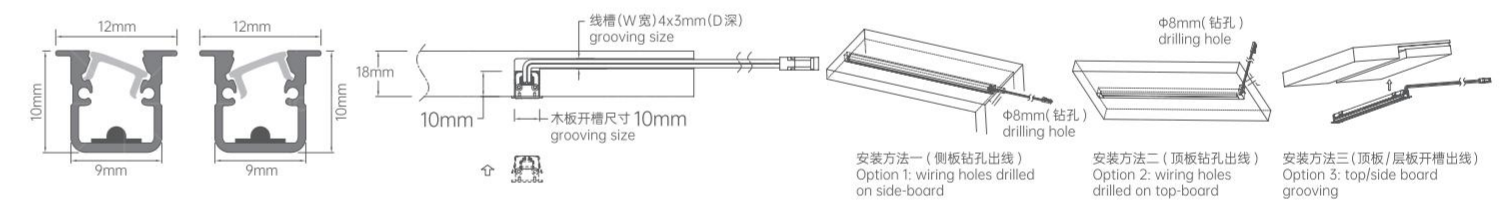

技术参数 TECHNICAL DETAILS

Color Temperature 色温 (K)	Item No. 型号	Highclass grey 太郎灰	Highclass grey 波尔多红 (定制)	Highclass grey 香槟金 (定制)	Size (mm) 尺寸 (mm)	Cutout Size(WxDmm) 开槽尺寸 (WXDmm)	Remark 备注
3000K	12823003	12823001	12823002	3000MM	10x10mm	/	
3500K	12825003	12825001	12825002	3000MM	10x10mm	/	
4000K	12824003	12824001	12824002	3000MM	10x10mm	/	
堵头 end cap	12820003A	12820001A	12820002A	PC 材质	/	与 1283 共用 Shared with 1283	
免焊堵头 welding-free end cap	12820003B	12820001B	12820002B	PC 材质	/	与 1283 共用 Shared with 1283	
堵头配件包 end cap accessory pack	12820003C	12820001C	12820002C	PC 材质	/	1对堵头, 1对卡扣, 1对螺丝 a pair of end cap, a pair of buckle, a pair of screw.	

光效图 LUMINOUS EFFECT DIAGRAM

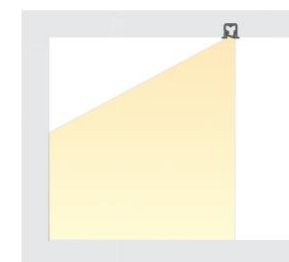

★ 电压: 12VDC, 连接方式: 诺米免焊端子线 (长度 1.5M, 非标配, 需单独下单)。NUOMI welding-free patch cords (1.5M, non-standard configuration, requires separate ordering).



产品特点 FEATURES

- 升级密集发光芯片设计, 可调或可选色温 (3000K、3500K、4000K) 柔和细腻流光, 无频闪不伤眼;
- 插入式灯线分离技术, 隐藏式防拉锁定设置, 适用性更广、稳定性更高;
- 高精度电路板, 全盘满锡工艺, 抗氧化耐高温, 寿命长;
- 灵活裁剪随心定制, 导电轨道全喷无铅锡工艺, 杜绝氧化;
- 卡扣式快装快拆结构, 操作更简单, 效率更高。
- Upgraded dense light-emitting chips, adjustable or optional color temperature (3000K、3500k、4000K), uniform illumination, lifespan over 54000 hours.
- Unleaded welding-free technology and detachable structure.
- High-density circuit board with full-tinning process for oxidation and high-temperature resistance.
- Flexible cutting, with lead-free tin spraying process on conductive tracks to prevent oxidation.
- Snap-on easy installation structure.

可选灯源色温 ADJUSTABLE COLOR TEMPERATURE

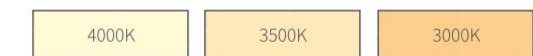

安装说明 INSTALLATION INSTRUCTIONS

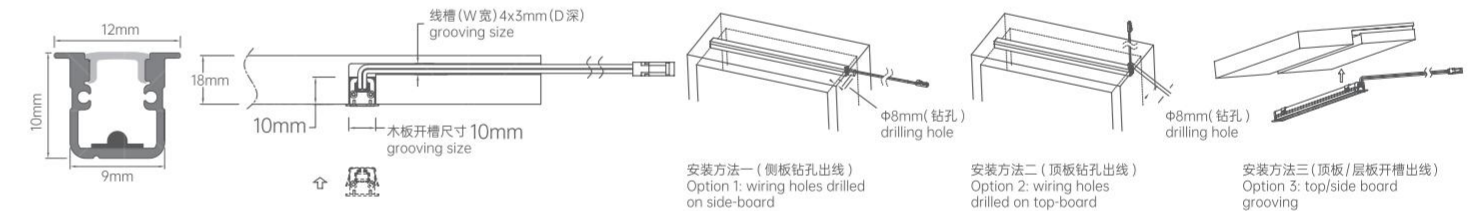

技术参数 TECHNICAL DETAILS

Color Temperature 色温 (K)	Item No. 型号	Highclass grey 太郎灰	Highclass grey 波尔多红 (定制)	Highclass grey 香槟金 (定制)	Size (mm) 尺寸 (mm)	Cutout Size(WXDmm) 开槽尺寸 (WXDmm)	Remark 备注
3000K	12833003	12833001	12833002	3000MM	10x10mm	/	
3500K	12835003	12835001	12835002	3000MM	10x10mm	/	
4000K	12834003	12834001	12834002	3000MM	10x10mm	/	
堵头 end cap	12820003A	12820001A	12820002A	PC 材质	/	与 1282 共用 Shared with 1282	
免焊堵头 welding-free end cap	12820003B	12820001B	12820002B	PC 材质	/	与 1282 共用 Shared with 1282	
堵头配件包 end cap accessory pack	12820003C	12820001C	12820002C	PC 材质	/	1 对堵头, 1 对卡扣, 1 对螺丝 a pair of end cap, a pair of buckle, a pair of screw.	

光效图 LUMINOUS EFFECT DIAGRAM

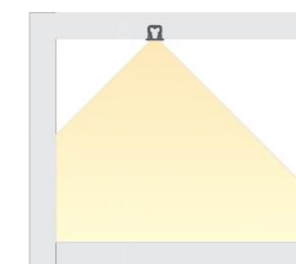

★ 电压: 12VDC, 连接方式: 诺米免焊端子线 (长度 1.5M, 非标配, 需单独下单)。NUOMI welding-free patch cords (1.5M, non-standard configuration, requires separate ordering).

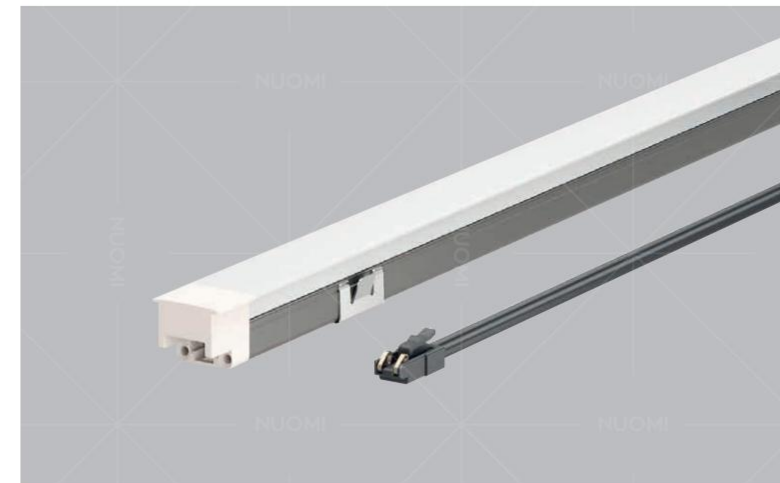

产品特点 FEATURES

- 升级密集发光芯片设计, 可调或可选色温 (3000K、3500K、4000K) 柔和细腻流光, 无频闪不伤眼;
- 插入式灯线分离技术, 隐藏式防拉锁定设置, 适用性更广、稳定性更高;
- 高精度电路板, 全盘满锡工艺, 抗氧化耐高温, 寿命长;
- 灵活裁剪随心定制, 导电轨道全喷无铅锡工艺, 杜绝氧化;
- 卡扣式快装快拆结构, 操作更简单, 效率更高。
- Upgraded dense light-emitting chips, adjustable or optional color temperature (3000K、3500k、4000K), uniform illumination, lifespan over 54000 hours.
- Unleaded welding-free technology and detachable structure.
- High-density circuit board with full-tinning process for oxidation and high-temperature resistance.
- Flexible cutting, with lead-free tin spraying process on conductive tracks to prevent oxidation.
- Snap-on easy installation structure.

可选灯源色温 ADJUSTABLE COLOR TEMPERATURE

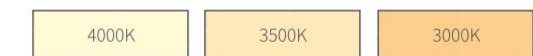

安装说明 INSTALLATION INSTRUCTIONS



技术参数 TECHNICAL DETAILS

Color Temperature 色温 (K)	Item No. 型号	Highclass grey 太郎灰	Highclass grey 波尔多红 (定制)	Highclass grey 香槟金 (定制)	Size (mm) 尺寸 (mm)	Cutout Size(WXDmm) 开槽尺寸 (WXDmm)	Remark 备注
3000K	12843003	12843001	12843002	3000MM	11x10mm	/	
3500K	12845003	12845001	12845002	3000MM	11x10mm	/	
4000K	12844003	12844001	12844002	3000MM	11x10mm	/	
免焊堵头 welding-free end cap	12843001A	12843001A	12843001A	乳白色	/	/	
堵头配件包 end cap accessory pack	12843001B	12843001B	12843001B	乳白色	/	1对堵头, 1对卡扣, 1对螺丝 a pair of end cap, a pair of buckle, a pair of screw.	

光效图 LUMINOUS EFFECT DIAGRAM

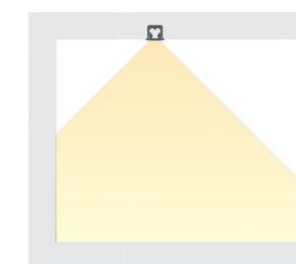

★ 电压: 12VDC, 连接方式: 诺米免焊端子线 (长度 1.5M, 非标配, 需单独下单)。NUOMI welding-free patch cords (1.5M, non-standard configuration, requires separate ordering).



产品特点 FEATURES

- 升级密集发光芯片设计，可调或可选色温（3000K、3500K、4000K）柔和细腻流光，无频闪不伤眼；
- 插入式灯线分离技术，隐藏式防拉锁定设置，适用性更广、稳定性更高；
- 高精度电路板，全盘满锡工艺，抗氧化耐高温，寿命长；
- 灵活裁剪随心定制，导电轨道全喷无铅锡工艺，杜绝氧化；
- 卡扣式快装快拆结构，操作更简单，效率更高。
- Upgraded dense light-emitting chips, adjustable or optional color temperature (3000K, 3500K, 4000K), uniform illumination, lifespan over 54000 hours.
- Unleaded welding-free technology and detachable structure.
- High-density circuit board with full-tinning process for oxidation and high-temperature resistance.
- Flexible cutting, with lead-free tin spraying process on conductive tracks to prevent oxidation.
- Snap-on easy installation structure.

可选灯源色温 ADJUSTABLE COLOR TEMPERATURE



安装说明 INSTALLATION INSTRUCTIONS

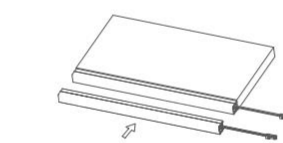
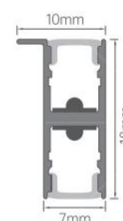

灯具安装在层板边的安装板上
The light bar mounted at the edge of the shelf

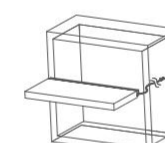

层板（含灯具）安装在柜子里
Install the shelf (with light bar) to the cabinet
层板错位 7mm，背板钻孔出线
The shelves are recessed 7mm, with wiring holes drilled on the back panel.

技术参数 TECHNICAL DETAILS

Color Temperature 色温 (K)	Item No. 型号	Highclass grey 太郎灰	Highclass grey 波尔多红 (定制)	Highclass grey 香槟金 (定制)	Size (mm) 尺寸 (mm)	Remark 备注
3000K	12853003	12853001	12853002	3000MM	/	
3500K	12855003	12855001	12855002	3000MM	/	
4000K	12854003	12854001	12854002	3000MM	/	
左堵头 left end cap	12850003A	12850001A	12850002A	PC 材质	与 1286 共用 shared with 1286	
免焊右堵头 welding-free right end cap	12850003B	12850001B	12850002B	PC 材质	与 1286 共用 shared with 1286	

光效图 LUMINOUS EFFECT DIAGRAM

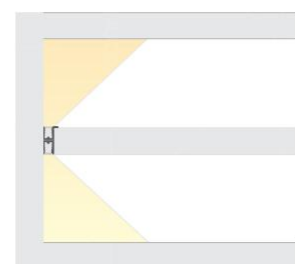

★ 电压：12VDC，连接方式：诺米免焊端子线或二合一免焊端子线（长度 1.5M，非标配，需单独下单）。NUOMI welding-free or two-in-one welding-free patch cords (1.5M, additional purchase is required).



产品特点 FEATURES

- 升级密集发光芯片设计，可调或可选色温（3000K、3500K、4000K）柔和细腻流光，无频闪不伤眼；
- 插入式灯线分离技术，隐藏式防拉锁定设置，适用性更广、稳定性更高；
- 高精度电路板，全盘满锡工艺，抗氧化耐高温，寿命长；
- 灵活裁剪随心定制，导电轨道全喷无铅锡工艺，杜绝氧化；
- 卡扣式快装快拆结构，操作更简单，效率更高。
- Upgraded dense light-emitting chips, adjustable or optional color temperature (3000K, 3500K, 4000K), uniform illumination, lifespan over 54000 hours.
- Unleaded welding-free technology and detachable structure.
- High-density circuit board with full-tinning process for oxidation and high-temperature resistance.
- Flexible cutting, with lead-free tin spraying process on conductive tracks to prevent oxidation.
- Snap-on easy installation structure.

可选灯源色温 ADJUSTABLE COLOR TEMPERATURE

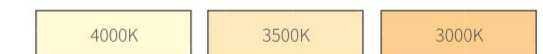

安装说明 INSTALLATION INSTRUCTIONS

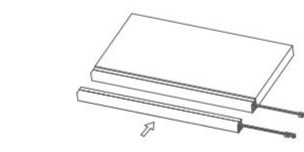
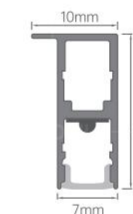

灯具安装在层板边的安装板上
The light bar mounted at the edge of the shelf

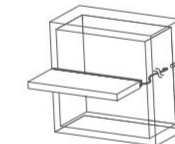

层板（含灯具）安装在柜子里
Install the shelf (with light bar) to the cabinet

层板错位 7mm，背板钻孔出线
The shelves are recessed 7mm, with wiring holes drilled on the back panel.

技术参数 TECHNICAL DETAILS

Color Temperature 色温 (K)	Item No. 型号	Highclass grey 太郎灰	Highclass grey 波尔多红 (定制)	Highclass grey 香槟金 (定制)	Size (mm) 尺寸 (mm)	Remark 备注
3000K	12863003	12863001	12863002	3000MM	/	
3500K	12865003	12865001	12865002	3000MM	/	
4000K	12864003	12864001	12864002	3000MM	/	
左堵头 left end cap	12850003A	12850001A	12850002A	PC 材质	与 1285 共用 shared with 1285	
免焊右堵头 welding free right end cap	12850003B	12850001B	12850002B	PC 材质	与 1285 共用 shared with 1285	

光效图 LUMINOUS EFFECT DIAGRAM

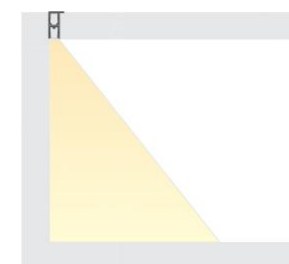

★ 电压：12VDC，连接方式：诺米免焊端子线（长度 1.5M，非标配，需单独下单）。NUOMI welding-free or two-in-one welding-free patch cords (1.5M, additional purchase is required).

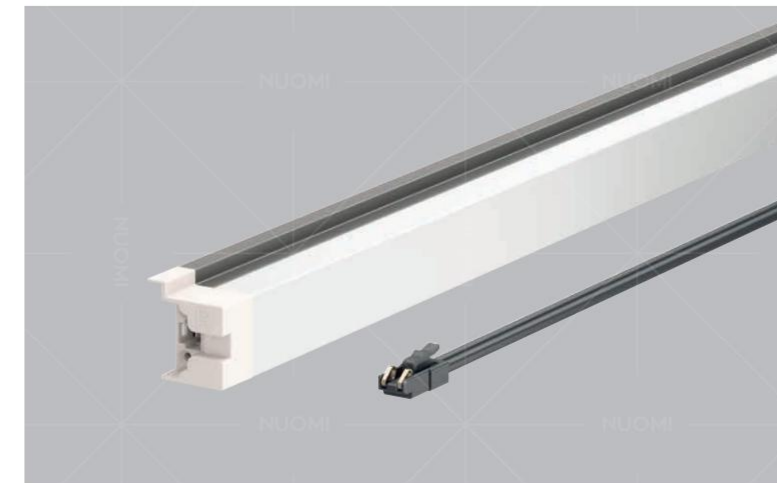

产品特点 FEATURES

- 升级密集发光芯片设计，可调或可选色温（3000K、3500K、4000K）柔和细腻流光，无频闪不伤眼；
- 插入式灯线分离技术，隐藏式防拉锁定设置，适用性更广、稳定性更高；
- 高精度电路板，全盘满锡工艺，抗氧化耐高温，寿命长；
- 灵活裁剪随心定制，导电轨道全喷无铅锡工艺，杜绝氧化；
- 卡扣式快装快拆结构，操作更简单，效率更高。
- Upgraded dense light-emitting chips, adjustable or optional color temperature (3000K、3500k、4000K), uniform illumination, lifespan over 54000 hours.
- Unleaded welding-free technology and detachable structure.
- High-density circuit board with full-tinning process for oxidation and high-temperature resistance.
- Flexible cutting, with lead-free tin spraying process on conductive tracks to prevent oxidation.
- Snap-on easy installation structure.

可选灯源色温 ADJUSTABLE COLOR TEMPERATURE

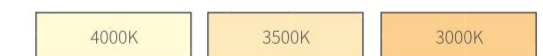

安装说明 INSTALLATION INSTRUCTIONS

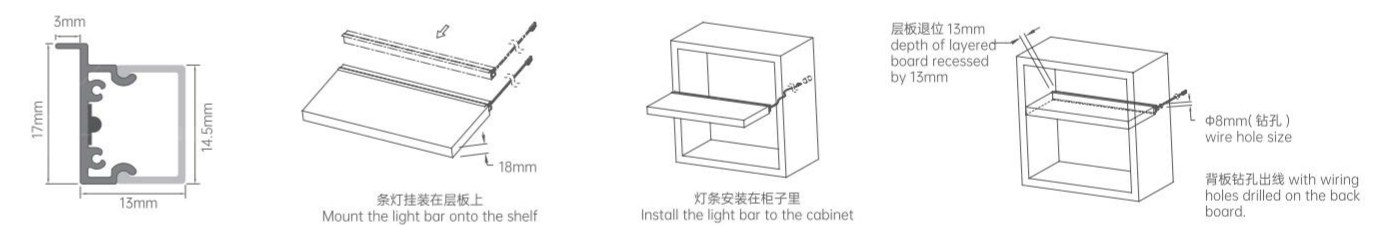

技术参数 TECHNICAL DETAILS

Color Temperature 色温 (K)	Item No. 型号	Highclass grey 太郎灰	Highclass grey 波尔多红 (定制)	Highclass grey 香槟金 (定制)	Size (mm) 尺寸 (mm)	Remark 备注
3000K	12873003	12873001	12873002	3000MM	/	
3500K	12875003	12875001	12875002	3000MM	/	
4000K	12874003	12874001	12874002	3000MM	/	
左堵头 left end cap	12873001B	12873001B	12873001B	乳白色 White	/	
免焊右堵头 welding-free right end cap	12873001A	12873001A	12873001A	乳白色 White	/	

光效图 LUMINOUS EFFECT DIAGRAM

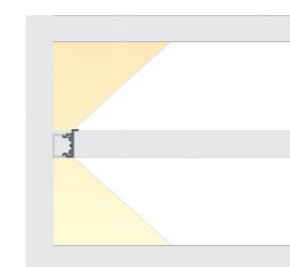

★ 电压：12VDC，连接方式：诺米免焊端子线（长度1.5M，非标配，需单独下单）。NUOMI welding-free or two-in-one welding-free patch cords (1.5M, additional purchase is required).



产品特点 FEATURES

- 升级密集发光芯片设计，可调或可选色温（3000K、3500K、4000K）柔和细腻流光，无频闪不伤眼；
- 插入式灯线分离技术，隐藏式防拉锁设置，适用性更广、稳定性更高；
- 高精度电路板，全盘满锡工艺，抗氧化耐高温，寿命长；
- 灵活裁剪随心定制，导电轨道全喷无铅锡工艺，杜绝氧化；
- 卡扣式快装快拆结构，操作更简单，效率更高。
- Upgraded dense light-emitting chips, adjustable or optional color temperature (3000K, 3500k, 4000K), uniform illumination, lifespan over 54000 hours.
- Unleaded welding-free technology and detachable structure.
- High-density circuit board with full-tinning process for oxidation and high-temperature resistance.
- Flexible cutting, with lead-free tin spraying process on conductive tracks to prevent oxidation.
- Snap-on easy installation structure.

可选灯源色温 ADJUSTABLE COLOR TEMPERATURE

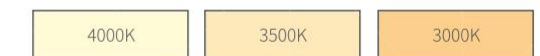

安装说明 INSTALLATION INSTRUCTIONS

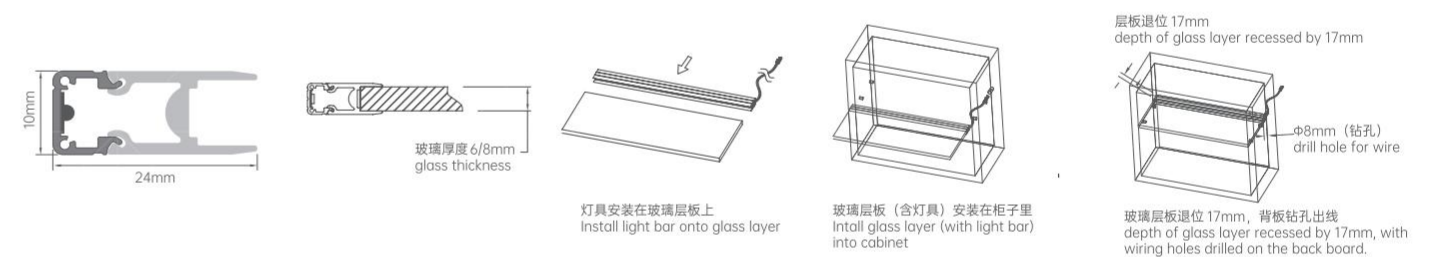

技术参数 TECHNICAL DETAILS

Color Temperature 色温 (K)	Item No. 型号	Highclass grey 太郎灰	Highclass grey 波尔多红 (定制)	Highclass grey 香槟金 (定制)	Size (mm) 尺寸 (mm)	Remark 备注
3000K	12883003		12883001	12883002	3000MM	/
3500K	12885003		12885001	12885002	3000MM	/
4000K	12884003		12884001	12884002	3000MM	/
免焊堵头 welding-free end cap	12883001A		12883001A	12883001A	乳白色 white	/

光效图 LUMINOUS EFFECT DIAGRAM

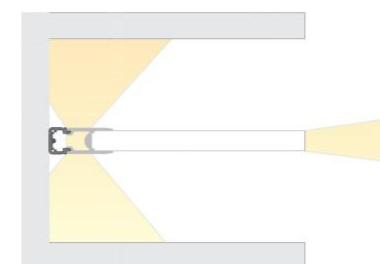

★ 电压：12VDC，连接方式：诺米免焊端子线（长度 1.5M，非标配，需单独下单）。NUOMI welding-free or two-in-one welding-free patch cords (1.5M, additional purchase is required).



产品特点 FEATURES

- 升级密集发光芯片设计，可调或可选色温（3000K、3500K、4000K）柔和细腻流光，无频闪不伤眼；
- 插入式灯线分离技术，隐藏式防拉锁设置，适用性更广、稳定性更高；
- 高精度电路板，全盘满锡工艺，抗氧化耐高温，寿命长；
- 灵活裁剪随心定制，导电轨道全喷无铅锡工艺，杜绝氧化；
- 卡扣式快装快拆结构，操作更简单，效率更高。
- Upgraded dense light-emitting chips, adjustable or optional color temperature (3000K、3500k、4000K), uniform illumination, lifespan over 54000 hours.
- Unleaded welding-free technology and detachable structure.
- High-density circuit board with full-tinning process for oxidation and high-temperature resistance.
- Flexible cutting, with lead-free tin spraying process on conductive tracks to prevent oxidation.
- Snap-on easy installation structure.

可选灯源色温 ADJUSTABLE COLOR TEMPERATURE

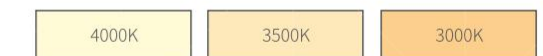

安装说明 INSTALLATION INSTRUCTIONS

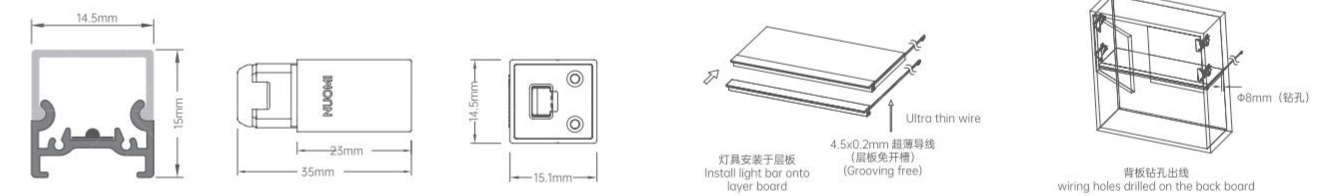

技术参数 TECHNICAL DETAILS

Color Temperature 色温 (K)	Item No. 型号	Bordeaux red 波尔多红 (定制)	Champagne golden 香槟金 (定制)	Size (mm) 尺寸 (mm)	Power 功率	Sensor switch 感应开关
3000K	12893303	12893301	12893302	3000mm	10W/M	可搭配以下两种堵头 Can be paired with the following two types of end caps.
3500K	12895303	12895301	12895302	3000mm	10W/M	
4000K	12894303	12894301	12894302	3000mm	10W/M	
免焊门控感应堵头 welding free door control sensor end cap	12222023	12222024	12222025	/	/	带门控感应开关 Door control sensor switch
免焊堵头配件套装 (无感应) end cap pack (without sensor switch)	12890003C	12890001C	12890002C	/	/	不带感应开关 without sensor switch

光效图 LUMINOUS EFFECT DIAGRAM

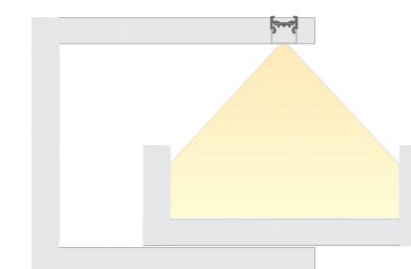



产品特点 FEATURES

- 采用高品质LED光源, 可选色温(3000K、3500K、4000K), 可调亮度, 出光均匀, 54000小时超长寿命;
- 免开槽免拉手设计, 下发光, 自带手扫感应, 适用于橱柜吊柜安装;
- 标配超薄导线, 走线不再钻孔外露;
- 显指 Ra>90。
- Optional color temperature (3000K, 3500K, 4000K), adjustable brightness, uniform illumination, ultra-long lifespan of 54000 hours.
- Grooving-free and concealed handle design, with downward illumination and built-in hand-sweep induction, suitable for cabinets and wall cupboard.
- Ultra thin wire, no-drill installation required.
- Ra>90.

可选灯源色温 ADJUSTABLE COLOR TEMPERATURE

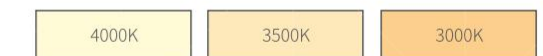

安装说明 INSTALLATION INSTRUCTIONS



技术参数 TECHNICAL DETAILS

Color Temperature 色温 (K)	Item No. 型号	Bordeaux red 波尔多红 (定制)	Champagne golden 香槟金 (定制)	Size (mm) 尺寸 (mm)	Power 功率	Sensor switch 感应开关
3000K	12913303	12913301	12913302	3000mm	10W/M	带手扫感应开关 hand sweep sensor switch
3500K	12915303	12915301	12915302	3000mm	10W/M	
4000K	12914303	12914301	12914302	3000mm	10W/M	
手扫感应堵头 hand sweep sensor switch end cap	12222026	12222027	12222028	/	/	

光效图 LUMINOUS EFFECT DIAGRAM

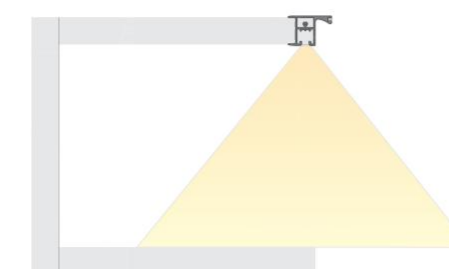

★ 电压: 12VDC, 连接方式: 杜邦端子线 (1.5M) 。Dupont wire (1.5M) .





产品特点 FEATURES

- 采用高品质 LED 光源, 可选色温 (3000K、3500K、4000K), 可调亮度, 出光均匀, 54000 小时超长寿命;
- 用于衣柜中, 结实铝材, 承重力强;
- 铝型材水性氟碳喷涂工艺;
- 显指 Ra>90。
- Optional color temperature (3000K、3500K、4000K), adjustable brightness, uniform illumination, ultra-long lifespan of 54000 hours.
- Used for wardrobes, sturdy aluminum profile with strong load-bearing capacity.
- Waterborne fluorocarbon coating.
- Ra>90.

可选灯源色温 ADJUSTABLE COLOR TEMPERATURE

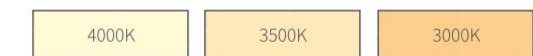

安装说明 INSTALLATION INSTRUCTIONS



技术参数 TECHNICAL DETAILS

Color Temperature 色温 (K)	Item No. 型号			Size (mm) 尺寸 (mm)	Power 功率	Sensor switch 感应开关
	Highclass grey 太郎灰	Bordeaux red 波尔多红 (定制)	Champagne golden 香槟金 (定制)			
3000K	12803303	12803301	12803302	3000mm	10W/M	
3500K	12805303	12805301	12805302	3000mm	10W/M	
4000K	12804303	12804301	12804302	3000mm	10W/M	
免焊人体感应堵头 Body infrared sensor end cap	12222021	12222020	12222022	/	/	人体红外感应开关 Body infrared sensor switch

光效图 LUMINOUS EFFECT DIAGRAM

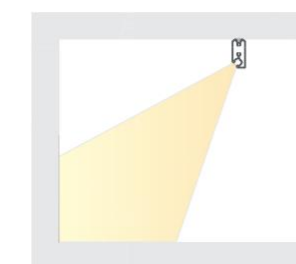

★ 电压: 12VDC, 连接方式: 杜邦端子线 (1.5M) 。Dupont wire (1.5M) .



产品特点 FEATURES

- 升级密集发光芯片设计，可调或可选色温（3000K、3500K、4000K）柔和细腻流光，无频闪不伤眼；
- 插入式灯线分离技术，隐藏式防拉锁设置，适用性更广、稳定性更高；
- 高精度电路板，全盘满锡工艺，抗氧化耐高温，寿命长；
- 灵活裁剪随心定制，导电轨道全喷无铅锡工艺，杜绝氧化；
- 卡扣式快装快拆结构，操作更简单，效率更高。
- Upgraded dense light-emitting chips, adjustable or optional color temperature (3000K, 3500K, 4000K), uniform illumination, lifespan over 54000 hours.
- Unleaded welding-free technology and detachable structure.
- High-density circuit board with full-tinning process for oxidation and high-temperature resistance.
- Flexible cutting, with lead-free tin spraying process on conductive tracks to prevent oxidation.
- Snap-on easy installation structure.

可选灯源色温 ADJUSTABLE COLOR TEMPERATURE

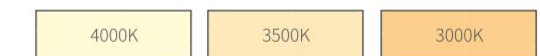

安装说明 INSTALLATION INSTRUCTIONS

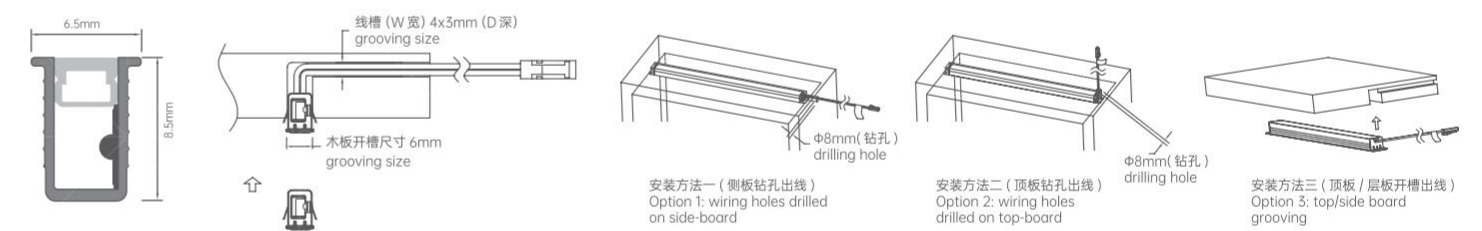

技术参数 TECHNICAL DETAILS

Color Temperature 色温 (K)	Item No. 型号	Highclass grey 太郎灰	Highclass grey 波尔多红 (定制)	Highclass grey 香槟金 (定制)	Size (mm) 尺寸 (mm)	Remark 备注
3000K	12953003	12953001	12953002	3000MM	/	
3500K	12955003	12955001	12955002	3000MM	/	
4000K	12954003	12954001	12954002	3000MM	/	
堵头 end cap	12950003B	12950001B	12950002B	/	/	
免焊堵头 welding-free end cap	12950003A	12950001A	12950002A	/	/	

光效图 LUMINOUS EFFECT DIAGRAM

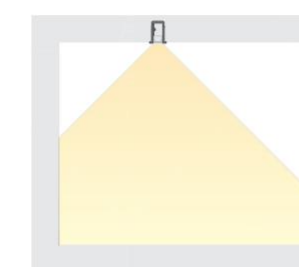

★ 电压：12VDC，连接方式：杜邦端子线（1.5M）。Dupont wire（1.5M）。



产品特点 FEATURES

- 升级密集发光芯片设计, 可调或可选色温 (3000K、3500K、4000K) 柔和细腻流光, 无频闪不伤眼;
- 插入式灯线分离技术, 隐藏式防拉锁设置, 适用性更广、稳定性更高;
- 高精度电路板, 全盘满锡工艺, 抗氧化耐高温, 寿命长;
- 灵活裁剪随心定制, 导电轨道全喷无铅锡工艺, 杜绝氧化;
- 卡扣式快装快拆结构, 操作更简单, 效率更高。
- Upgraded dense light-emitting chips, adjustable or optional color temperature (3000K、3500k、4000K), uniform illumination, lifespan over 54000 hours.
- Unleaded welding-free technology and detachable structure.
- High-density circuit board with full-tinning process for oxidation and high-temperature resistance.
- Flexible cutting, with lead-free tin spraying process on conductive tracks to prevent oxidation.
- Snap-on easy installation structure.

可选灯源色温 ADJUSTABLE COLOR TEMPERATURE



安装说明 INSTALLATION INSTRUCTIONS



技术参数 TECHNICAL DETAILS

Color Temperature 色温 (K)	Item No. 型号	Highclass grey 太郎灰	Highclass grey 波尔多红 (定制)	Highclass grey 香棋金 (定制)	Size (mm) 尺寸 (mm)	Remark 备注
3000K	12973003	12973001	12973002	3000MM	/	
3500K	12975003	12975001	12975002	3000MM	/	
4000K	12974003	12974001	12974003	3000MM	/	
堵头 end cap	12970003B	12970001B	12970002B	/	/	
免焊堵头 welding-free end cap	12970003A	12970001A	12970002A	/	/	

光效图 LUMINOUS EFFECT DIAGRAM

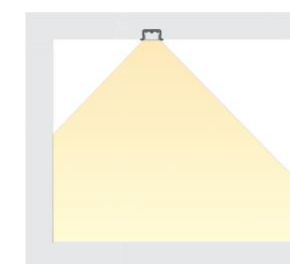

★ 电压: 12VDC, 连接方式: 杜邦端子线 (1.5M) 。Dupont wire (1.5M) .



产品特点 FEATURES

- 升级密集发光芯片设计，可调或可选色温（3000K、3500K、4000K）柔和细腻流光，无频闪不伤眼；
- 插入式灯线分离技术，隐藏式防拉锁设置，适用性更广、稳定性更高；
- 高精度电路板，全盘满锡工艺，抗氧化耐高温，寿命长；
- 灵活裁剪随心定制，导电轨道全喷无铅锡工艺，杜绝氧化；
- 卡扣式快装快拆结构，操作更简单，效率更高。
- Upgraded dense light-emitting chips, adjustable or optional color temperature (3000K、3500k、4000K), uniform illumination, lifespan over 54000 hours.
- Unleaded welding-free technology and detachable structure.
- High-density circuit board with full-tinning process for oxidation and high-temperature resistance.
- Flexible cutting, with lead-free tin spraying process on conductive tracks to prevent oxidation.
- Snap-on easy installation structure.

可选灯源色温 ADJUSTABLE COLOR TEMPERATURE

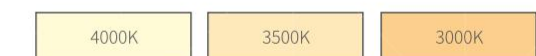

安装说明 INSTALLATION INSTRUCTIONS



技术参数 TECHNICAL DETAILS

Color Temperature 色温 (K)	Item No. 型号	Highclass grey 太郎灰	Highclass grey 波尔多红 (定制)	Highclass grey 香槟金 (定制)	Size (mm) 尺寸 (mm)	Remark 备注
3000K	12993303		12993301	12993302	3000MM	/
3500K	12995303		12995301	12995302	3000MM	/
4000K	12994303		12994301	12994302	3000MM	/
堵头 end cap	12990003B		12990001B	12990002B	/	/
免焊堵头 welding-free end cap	12990003A		12990001A	12990002A	/	/

光效图 LUMINOUS EFFECT DIAGRAM

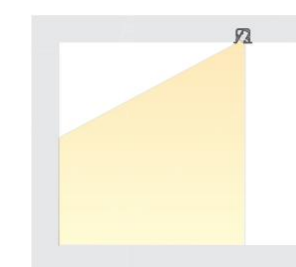

★ 电压：12VDC，连接方式：杜邦端子线（1.5M）。Dupont wire（1.5M）。



ROCKS LIGHT

洛克斯系列

Clean and comfortable space, more full and orderly combination of different modules, breaking the monotony of the plane, bring undulating rhythm.

干净而舒适的空间，不同模块组合更显饱满有序，突破了平面的单调，带来更具起伏的韵律与节奏。

WELDING-FREE EASY ASSEMBLY 真正的灯线分离

- 镀金触点与全锡焊盘精准对接
- 防拉锁定设置，插头不松脱
- Gold-plated contacts precisely docked with full tin solder pads;
- Welding-free Easy Assembly
- Anti-pull locking setting, ensuring plug stability

全锡焊盘 Full tin solder pads

镀金触点 Gold-plated contact

锁定弹片 Locking clip

孔位

高配灯带 发光效果更好

HIGH-END LIGHT STRIPS FOR BETTER
ILLUMINATION EFFECTS



0.8cm



高配灯带理论最大发光暗区 0.8cm
Theoretical maximum dark area of 0.8cm for high-end light strips

FULL TIN SOLDER PADS TO
PREVENT CONTACT OXIDATION

全锡焊盘，杜绝触点氧化

- 无铅全锡焊盘，抗氧化、且环保
- 超强抗氧化，通过 48 小时盐雾测试
- Lead-free full tin solder pads for oxidation resistance and environmental friendliness;
- Superior anti-oxidation, passing 48-hour salt spray test.

48

 hours

SIX CORE SELLING POINTS 六大核心卖点

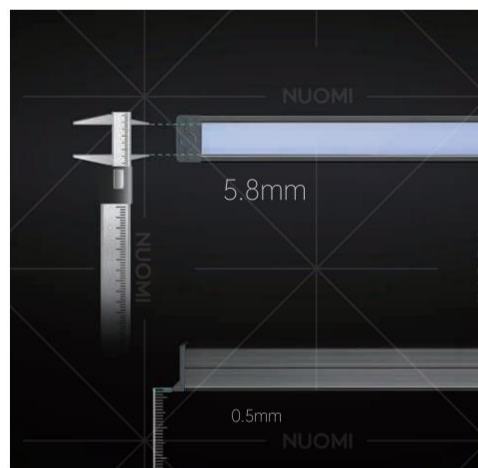

1、极简超窄
MINIMALISM ULTRA NARROW
STRIP LIGHTS

- 迎合当下流行的极简轻奢风格需要的极简超窄灯条款式；
- 极简超窄 PC 灯条，发光面低至 5.8mm，行业极窄。

- Follow current trend, minimalism light luxury style
- Ultra narrow pc lampshade, luminous surface area 5.8mm.

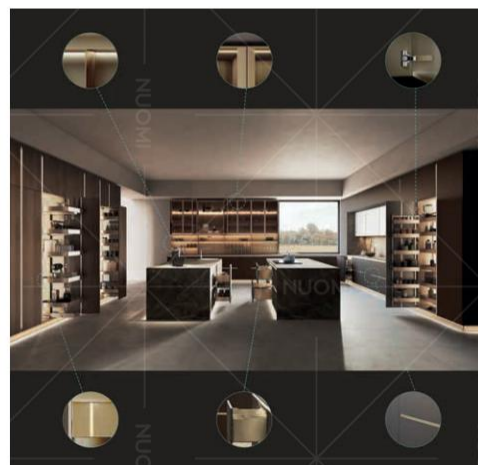

2、全屋五金轻奢同色
WHOLE HOUSE HARDWARE
WITH MATCHING COLOR IN
LIGHT LUXURY STYLE

- 诺米打造的全屋五金产品生态链，基于完善的产品体系，实现全屋五金轻奢同色。
- 全屋所有的五金，包括拉篮、衣帽间收纳、拉手、灯光等，家居里能见光的五金颜色一致，整体性更强，突显高级感。

- Based on complete product system and own surface treatment factory, nuomi keep whole house hardware in consistency
- light luxury color including kitchen storage system, wardrobe storage system, handles etc., Whole house hardware keep color consistency, makes overall design more integrated, advanced design sense stands out.

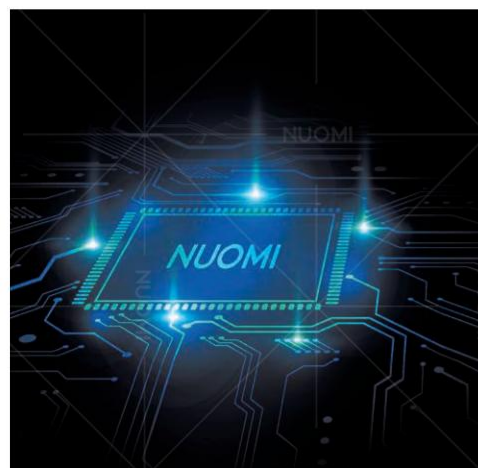

3、顶流智能控制系统
TOP-OF-THE-LINE SMART CONTROL
SYSTEM

- 全面覆盖多语音平台、手扫、人身红外感应、门板感应等控制方式；
- 聚集国内外行业精英工程师的强大研发团队，沉淀多年技术积累，自主创新专利技术。

- Smart control system including various ways, multivoice platform, hand-sweeping induction, human body infrared induction, gate induction, etc.
- Gathering industry senior elites, with many years technology and experience, nuomi have strong r&d ability, own many creative patent.

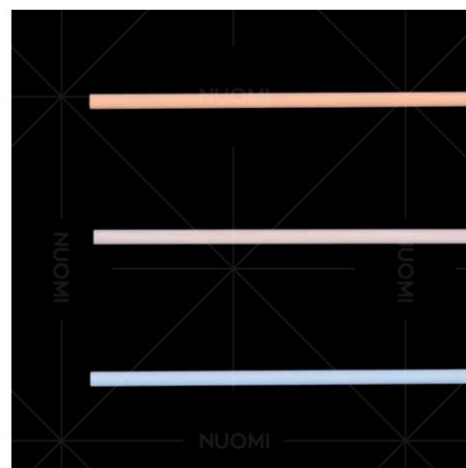

4、3 色温智能切换技术
SMART SWITCH TECHNOLOGY OF THREE
COLORS TEMPERATURE

- 磁悬式 AI 智能 3 色温切换技术；
- 满足用户不同场景的色温需求，灵活控制轻松切换；家居生活体验更丰富，应用更贴心。

- Industry-leading smart switch of three colors temperature.
- Fulfill different application of scenarios, flexible and convenient. Provide rich home living experience, intimate design.



5、高标准产品质量保障
HIGH STANDARD PRODUCT QUALITY
GUARANTEE

- 超欧标的电源电子元件、电路板；
- 光源灯珠采用国际品牌高亮芯片，高强度支架封装，灯珠显指 90 以上；
- 电源和灯珠，在正常使用情况下提供 10 年质保。

- Quality of electric components, circuit board use the highest standard of industry.
- High brightness led of sanan, strong rack, ra of led ≥90
- 10 Years service life for power supply and led

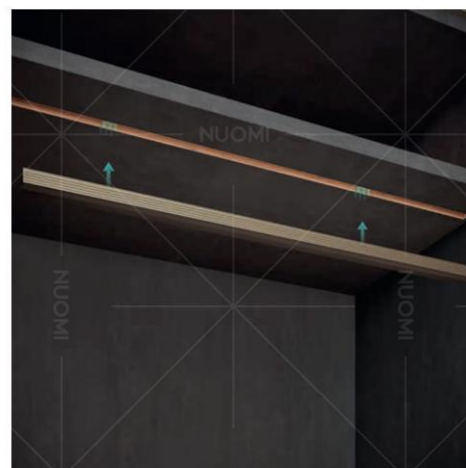

6、灯线分离及卡扣式的快装结构
LIGHT AND WIRE SEPARATION STRUCTURE,
SNAP-ON QUICK INSTALLATION

- 采用插入式灯线分离技术，检修无忧；
- 卡扣式快装快拆结构，解决安装痛点；
- 防拉锁定装置，插线不松脱。

- Inserted light-wire separation structure, meanwhile guarantee quality;
- Clip-on fast mounted structure, solve installation difficulty;
- Anti-pull locking device, the plug will not be loosened.



产品特点 FEATURES

- 采用高品质 LED 光源, 可调或可选色温 (3000K、4000K、6000K) 可调亮度, 出光均匀, 54000 小时超长寿命;
- 采用无铅免焊技术, 灯线分离结构;
- 可用于嵌入式层板、立板安装, 灯条可裁切;
- 超薄设计 PC 灯罩, 无晶点;
- 显指 >90。
- High-quality LED light sources, with adjustable or selectable color temperature (3000K, 4000K, 6000K) and brightness, ensuring uniform illumination and an ultra-long lifespan of 54,000 hours.
- Welding-free and solder-free, easy assembly structure.
- Suitable for embedded layer board and vertical board installation, with the light strip being flexible cutting.
- Features an ultra-narrow design PC lampshade without visible dots.
- RA>90.

可调灯源色温 ADJUSTABLE COLOR TEMPERATURE

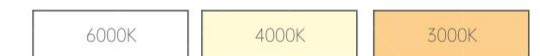

安装说明 INSTALLATION INSTRUCTIONS

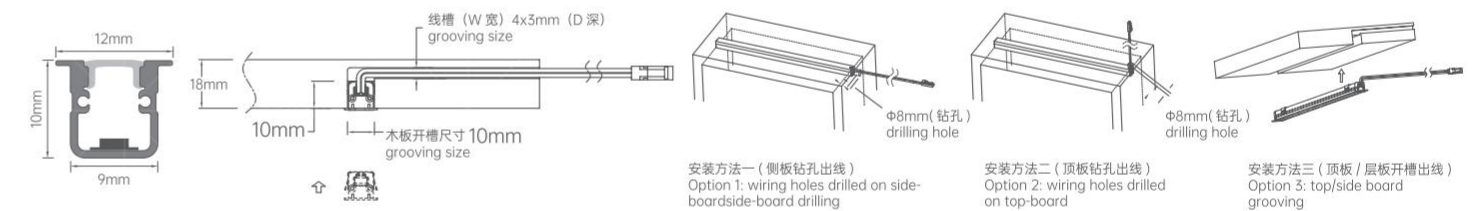

技术参数 TECHNICAL DETAILS

Color Temperature 色温 (K)	Item No. 型号	Highclass grey 太郎灰	Highclass grey 波尔多红 (定制)	Highclass grey 香槟金 (定制)	Size (mm) 尺寸 (mm)	Cutout Size (WxDmm) 开槽尺寸 (WxDmm)	Power 功率
可调 3 色温 (3000K-4000K-6000K) 通过智能控制盒实现 3 色温自由调节 3-color temperature adjustment available via a smart control box	12780053	12780051	12780052	500MM	10x10mm	5W	
	12780063	12780061	12780062	600MM		6W	
	12780073	12780071	12780072	700MM		7W	
	12780083	12780081	12780082	800MM		8W	
	12780093	12780091	12780092	900MM		9W	
	12780103	12780101	12780102	1000MM		10W	
	12780123	12780121	12780122	1200MM		12W	
	12780143	12780141	12780142	1400MM		14W	
	12780163	12780161	12780162	1600MM		16W	
	12780183	12780181	12780182	1800MM		18W	
	12780203	12780201	12780202	2000MM		20W	
	12780223	12780221	12780222	2200MM		22W	
	12780243	12780241	12780242	2400MM		24W	
	12780303	12780301	12780302	3000MM		30W	

★ 电压: 12VDC, 连接方式: 诺米免焊端子线 (长度 1.5M, 非标配, 需单独下单)。NUOMI welding-free or two-in-one welding-free patch cords (1.5M, additional purchase is required).



产品特点 FEATURES

- 采用高品质 LED 光源，可调或可选色温 (3000K、4000K、6000K) 可调亮度，出光均匀，54000 小时超长寿命；
- 采用无铅免焊技术，灯线分离结构；
- 见光不见灯，灯条可裁切；
- 超薄设计 PC 灯罩，无晶点；
- 显指 >90。
- High-quality LED light sources, with adjustable or selectable color temperature (3000K, 4000K, 6000K) and brightness, ensuring uniform illumination and an ultra-long lifespan of 54,000 hours.
- Welding-free and solder-free, easy assembly structure.
- Suitable for embedded layer board and vertical board installation, with the light strip being flexible cutting.
- Features an ultra-narrow design PC lampshade without visible dots.
- RA>90.

可调灯源色温 ADJUSTABLE COLOR TEMPERATURE

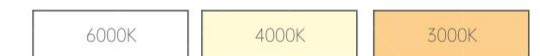

安装说明 INSTALLATION INSTRUCTIONS

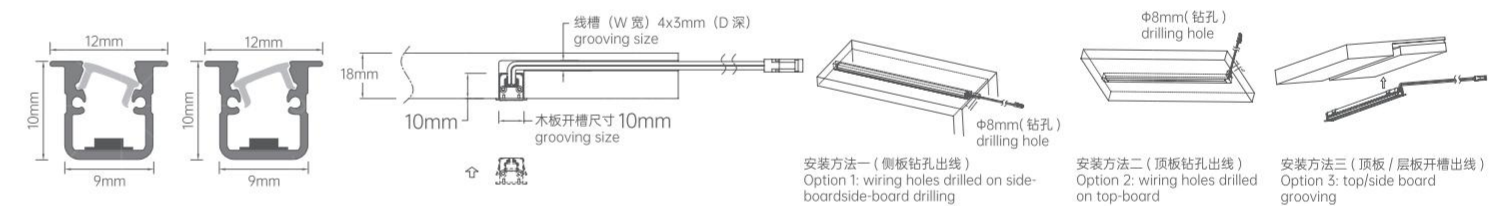

技术参数 TECHNICAL DETAILS

Color Temperature 色温 (K)	Item No. 型号	Highclass grey 太郎灰	Highclass grey 波尔多红 (定制)	Highclass grey 香槟金 (定制)	Size (mm) 尺寸 (mm)	Cutout Size (WxDmm) 开槽尺寸 (WxDmm)	Power 功率
可调 3 色温 (3000K-4000K-6000K) 通过智能控制盒实现 3 色温自由调节 3-color temperature adjustment available via a smart control box	12720053		12720051	12720052	500MM	10x10mm	5W
	12720063		12720061	12720062	600MM		6W
	12720073		12720071	12720072	700MM		7W
	12720083		12720081	12720082	800MM		8W
	12720093		12720091	12720092	900MM		9W
	12720103		12720101	12720102	1000MM		10W
	12720123		12720121	12720122	1200MM		12W
	12720143		12720141	12720142	1400MM		14W
	12720163		12720161	12720162	1600MM		16W
	12720183		12720181	12720182	1800MM		18W
	12720203		12720201	12720202	2000MM		20W
	12720223		12720221	12720222	2200MM		22W
	12720243		12720241	12720242	2400MM		24W
12720303		12720301	12720302	3000MM	30W		

★ 电压: 12VDC, 连接方式: 诺米免焊端子线 (长度 1.5M, 非标配, 需单独下单)。NUOMI welding-free or two-in-one welding-free patch cords (1.5M, additional purchase is required).



产品特点 FEATURES

- 采用高品质 LED 光源，可调或可选色温 (3000K、4000K、6000K) 可调亮度，出光均匀，54000 小时超长寿命；
- 采用无铅免焊技术，灯线分离结构；
- 可用于嵌入式层板、立板安装，灯条可裁切；
- 超窄设计 PC 灯罩，无晶点；
- 显指 >90。
- High-quality LED light sources, with adjustable or selectable color temperature (3000K, 4000K, 6000K) and brightness, ensuring uniform illumination and an ultra-long lifespan of 54,000 hours.
- Welding-free and solder-free, easy assembly structure.
- Suitable for embedded layer board and vertical board installation, with the light strip being flexible cutting.
- Features an ultra-narrow design PC lampshade without visible dots.
- RA>90.

可调灯源色温 ADJUSTABLE COLOR TEMPERATURE

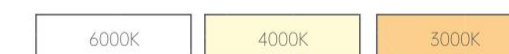

安装说明 INSTALLATION INSTRUCTIONS



技术参数 TECHNICAL DETAILS

Color Temperature 色温 (K)	Item No. 型号	Highclass grey 太郎灰	Highclass grey 波尔多红 (定制)	Highclass grey 香槟金 (定制)	Size (mm) 尺寸 (mm)	Cutout Size (WxDmm) 开槽尺寸 (WxDmm)	Power 功率
可调 3 色温 (3000K-4000K-6000K) 通过智能控制盒实现 3 色温自由调节 3-color temperature adjustment available via a smart control box	12710053		12710051	12710052	500MM	8x10mm	5W
	12710063		12710061	12710062	600MM		6W
	12710073		12710071	12710072	700MM		7W
	12710083		12710081	12710082	800MM		8W
	12710093		12710091	12710092	900MM		9W
	12710103		12710101	12710102	1000MM		10W
	12710123		12710121	12710122	1200MM		12W
	12710143		12710141	12710142	1400MM		14W
	12710163		12710161	12710162	1600MM		16W
	12710183		12710181	12710182	1800MM		18W
	12710203		12710201	12710202	2000MM		20W
	12710223		12710221	12710222	2200MM		22W
	12710243		12710241	12710242	2400MM		24W
	12710303		12710301	12710302	3000MM		30W

★ 电压: 12VDC, 连接方式: 诺米免焊端子线 (长度 1.5M, 非标配, 需单独下单)。NUOMI welding-free or two-in-one welding-free patch cords (1.5M, additional purchase is required).



产品特点 FEATURES

- 采用高品质 LED 光源，可调或可选色温 (3000K、4000K、6000K) 可调亮度，出光均匀，54000 小时超长寿命；
- 采用无铅免焊技术，灯线分离结构；
- 用于层板后口安装，见光不见灯，光效柔和，可裁切；
- 超薄设计 PC 灯罩，无晶点；
- 显指 >90。
- High-quality LED light sources, with adjustable or selectable color temperature (3000K, 4000K, 6000K) and brightness, ensuring uniform illumination and an ultra-long lifespan of 54,000 hours.
- Welding-free and solder-free, easy assembly structure.
- Suitable for embedded layer board and vertical board installation, with the light strip being flexible cutting.
- Features an ultra-narrow design PC lampshade without visible dots.
- RA>90.

可调灯源色温 ADJUSTABLE COLOR TEMPERATURE



安装说明 INSTALLATION INSTRUCTIONS

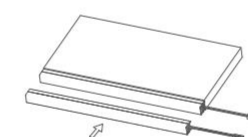
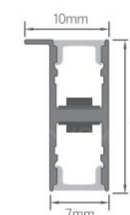

灯具安装在层板边的安装板上
The light bar mounted at the edge of the shelf

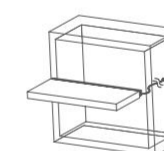

层板 (含灯具) 安装在柜子里
Install the shelf (with light bar) to the cabinet

层板错位 7mm, 背板钻孔出线
The shelves are recessed by 7mm, with wiring holes drilled on the back board.

技术参数 TECHNICAL DETAILS

Color Temperature 色温 (K)	Item No. 型号	Highclass grey 太郎灰	Highclass grey 波尔多红 (定制)	Highclass grey 香槟金 (定制)	Size (mm) 尺寸 (mm)	Power 功率	Remark 备注
可调 3 色温 (3000K-4000K-6000K) 通过智能控制盒实现 3 色温自由调节 3-color temperature adjustment available via a smart control box	12740053	12740051	12740052	500MM	10W		
	12740063	12740061	12740062	600MM	12W		
	12740073	12740071	12740072	700MM	14W		
	12740083	12740081	12740082	800MM	16W		
	12740093	12740091	12740092	900MM	18W		
	12740103	12740101	12740102	1000MM	20W		使用二合一免焊端子线 Using two-in-one welding-free terminal wires
	12740123	12740121	12740122	1200MM	24W		
	12740143	12740141	12740142	1400MM	28W		
	12740163	12740161	12740162	1600MM	32W		
	12740183	12740181	12740182	1800MM	36W		
	12740203	12740201	12740202	2000MM	40W		
	12740223	12740221	12740222	2200MM	44W		使用两条免焊端子线 Using two-in-one welding-free terminal wires
	12740243	12740241	12740242	2400MM	48W		
	12740303	12740301	12740302	3000MM	60W		

★ 电压: 12VDC, 连接方式: 诺米免焊端子线或二合一免焊端子线 (长度 1.5M, 非标配, 需单独下单)。NUOMI welding-free or two-in-one welding-free patch cords (1.5M, additional purchase is required).



产品特点 FEATURES

- 采用高品质 LED 光源，可调或可选色温（3000K、4000K、6000K）可调亮度，出光均匀，54000 小时超长寿命；
- 采用无铅免焊技术，灯线分离结构；
- 用于层板后口安装，见光不见灯，光效柔和，可裁切；
- 超薄设计 PC 灯罩，无晶点；
- 显指 >90。
- High-quality LED light sources, with adjustable or selectable color temperature (3000K, 4000K, 6000K) and brightness, ensuring uniform illumination and an ultra-long lifespan of 54,000 hours.
- Welding-free and solder-free, easy assembly structure.
- Suitable for embedded layer board and vertical board installation, with the light strip being flexible cutting.
- Features an ultra-narrow design PC lampshade without visible dots.
- RA>90.

可调灯源色温 ADJUSTABLE COLOR TEMPERATURE

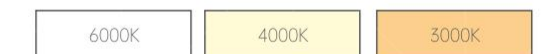

安装说明 INSTALLATION INSTRUCTIONS

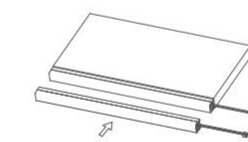
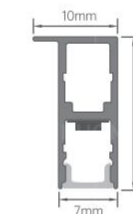

灯具安装在层板边的安装板上
The light bar mounted at the edge of the shelf

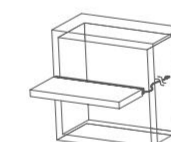

层板退位 7mm，背板钻孔出线
The shelves are recessed by 7mm, with wiring holes drilled on the back board.
层板（含灯具）安装在柜子里
Install the shelf (with light bar) to the cabinet

技术参数 TECHNICAL DETAILS

Color Temperature 色温 (K)	Item No. 型号	Highclass grey 太郎灰	Highclass grey 波尔多红 (定制)	Highclass grey 香槟金 (定制)	Size (mm) 尺寸 (mm)	Power 功率
可调 3 色温 (3000K-4000K-6000K) 通过智能控制盒实现 3 色温自由调节	12750053		12750051	12750052	500MM	5W
	12750063		12750061	12750062	600MM	6W
	12750073		12750071	12750072	700MM	7W
	12750083		12750081	12750082	800MM	8W
	12750093		12750091	12750092	900MM	9W
	12750103		12750101	12750102	1000MM	10W
	12750123		12750121	12750122	1200MM	12W
	12750143		12750141	12750142	1400MM	14W
	12750163		12750161	12750162	1600MM	16W
	12750183		12750181	12750182	1800MM	18W
3-color temperature adjustment available via a smart control box	12750203		12750201	12750202	2000MM	20W
	12750223		12750221	12750222	2200MM	22W
	12750243		12750241	12750242	2400MM	24W
	12750303		12750301	12750302	3000MM	30W

★ 电压：12VDC，连接方式：诺米免焊端子线（长度 1.5M，非标配，需单独下单）。NUOMI welding-free or two-in-one welding-free patch cords (1.5M, additional purchase is required).



产品特点 FEATURES

- 采用高品质 LED 光源，可调或可选色温 (3000K、4000K、6000K) 可调亮度，出光均匀，54000 小时超长寿命；
- 采用无铅免焊技术，灯线分离结构；
- 用于层板后口安装，见光不见灯，光效柔和，可裁切；
- 显指 >90。
- High-quality LED light sources, with adjustable or selectable color temperature (3000K, 4000K, 6000K) and brightness, ensuring uniform illumination and an ultra-long lifespan of 54,000 hours.
- Welding-free and solder-free, easy assembly structure.
- Designed for installation behind the layer board, with the light hidden from direct view, providing soft and even lighting, flexible cutting.
- RA>90.

可调灯源色温 ADJUSTABLE COLOR TEMPERATURE

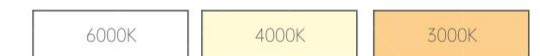

安装说明 INSTALLATION INSTRUCTIONS

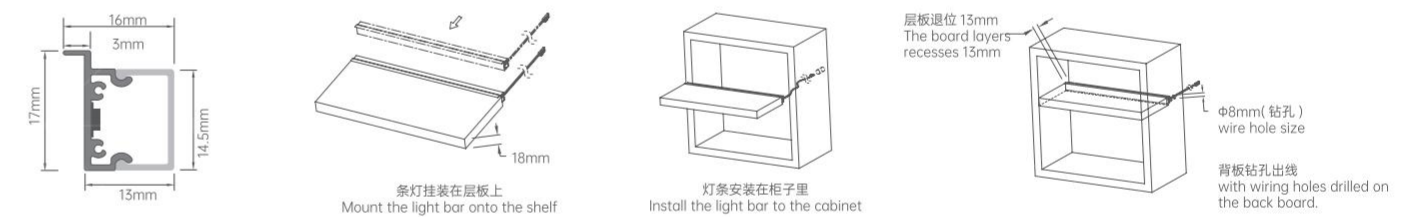

技术参数 TECHNICAL DETAILS

Color Temperature 色温 (K)	Item No. 型号	Highclass grey 太郎灰	Highclass grey 波尔多红 (定制)	Highclass grey 香槟金 (定制)	Size (mm) 尺寸 (mm)	Power 功率
可调 3 色温 (3000K-4000K-6000K) 通过智能控制盒实现 3 色温自由调节 3-color temperature adjustment available via a smart control box	12730053	12730051	12730052	500MM	5W	
	12730063	12730061	12730062	600MM	6W	
	12730073	12730071	12730072	700MM	7W	
	12730083	12730081	12730082	800MM	8W	
	12730093	12730091	12730092	900MM	9W	
	12730103	12730101	12730102	1000MM	10W	
	12730123	12730121	12730122	1200MM	12W	
	12730143	12730141	12730142	1400MM	14W	
	12730163	12730161	12730162	1600MM	16W	
	12730183	12730181	12730182	1800MM	18W	
	12730203	12730201	12730202	2000MM	20W	
	12730223	12730221	12730222	2200MM	22W	
	12730243	12730241	12730242	2400MM	24W	
	12730303	12730301	12730302	3000MM	30W	

★ 电压：12VDC，连接方式：诺米免焊端子线（长度 1.5M，非标配，需单独下单）。NUOMI welding-free or two-in-one welding-free patch cords (1.5M, additional purchase is required).

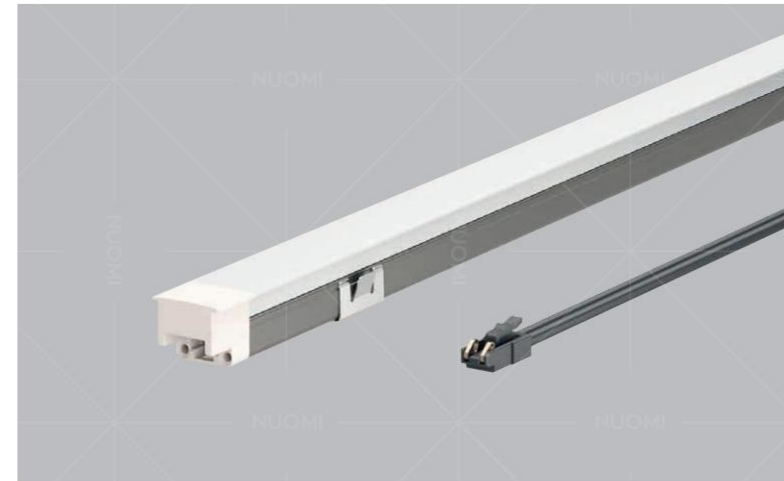

产品特点 FEATURES

- 采用高品质 LED 光源，可调或可选色温 (3000K、4000K、6000K) 可调亮度，出光均匀，54000 小时超长寿命；
- 采用无铅免焊技术，灯线分离结构；
- 可用于嵌入式层板、立板安装，灯条可裁切；
- 显指 >90。
- High-quality LED light sources, with adjustable or selectable color temperature (3000K, 4000K, 6000K) and brightness, ensuring uniform illumination and an ultra-long lifespan of 54,000 hours.
- Welding-free and solder-free, easy assembly structure.
- Can be used for embedded layer board, flexible cutting.
- RA>90.

可调灯源色温 ADJUSTABLE COLOR TEMPERATURE



安装说明 INSTALLATION INSTRUCTIONS



技术参数 TECHNICAL DETAILS

Color Temperature 色温 (K)	Item No. 型号	Highclass grey 太郎灰	Highclass grey 波尔多红 (定制)	Highclass grey 香槟金 (定制)	Size (mm) 尺寸 (mm)	Cutout Size (WxDmm) 开槽尺寸 (WXDmm)	Power 功率
可调 3 色温 (3000K-4000K-6000K) 通过智能控制盒实现 3 色温自由调节	12790053		12790051	12790052	500MM	11x10mm	5W
	12790063		12790061	12790062	600MM		6W
	12790073		12790071	12790072	700MM		7W
	12790083		12790081	12790082	800MM		8W
	12790093		12790091	12790092	900MM		9W
	12790103		12790101	12790102	1000MM		10W
	12790123		12790121	12790122	1200MM		12W
	12790143		12790141	12790142	1400MM		14W
	12790163		12790161	12790162	1600MM		16W
	12790183		12790181	12790182	1800MM		18W
3-color temperature adjustment available via a smart control box	12790203		12790201	12790202	2000MM	20W	
	12790223		12790221	12790222	2200MM	22W	
	12790243		12790241	12790242	2400MM	24W	
	12790303		12790301	12790302	3000MM	30W	

★ 电压：12VDC，连接方式：诺米免焊端子线（长度 1.5M，非标配，需单独下单）。NUOMI welding-free or two-in-one welding-free patch cords (1.5M, additional purchase is required).



产品特点 FEATURES

- 采用高品质 LED 光源，可调或可选色温 (3000K、4000K、6000K) 可调亮度，出光均匀，54000 小时超长寿命；
- 采用无铅免焊技术，灯线分离结构；
- 三面发光，无光点，适合安装 6-8mm 的玻璃；
- 可用于衣柜、开放柜等后口玻璃层板，可裁切；
- 显指 >90。
- High-quality LED light sources, with adjustable or selectable color temperature (3000K, 4000K, 6000K) and brightness, ensuring uniform illumination and an ultra-long lifespan of 54,000 hours.
- Welding-free and solder-free, easy assembly structure.
- Three-sided illumination with no visible light points, suitable for installing 6-8mm glass;
- Can be used for glass shelves in closets, open cabinets, flexible cutting.
- RA>90.

可调光源色温 ADJUSTABLE COLOR TEMPERATURE

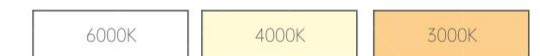

安装说明 INSTALLATION INSTRUCTIONS

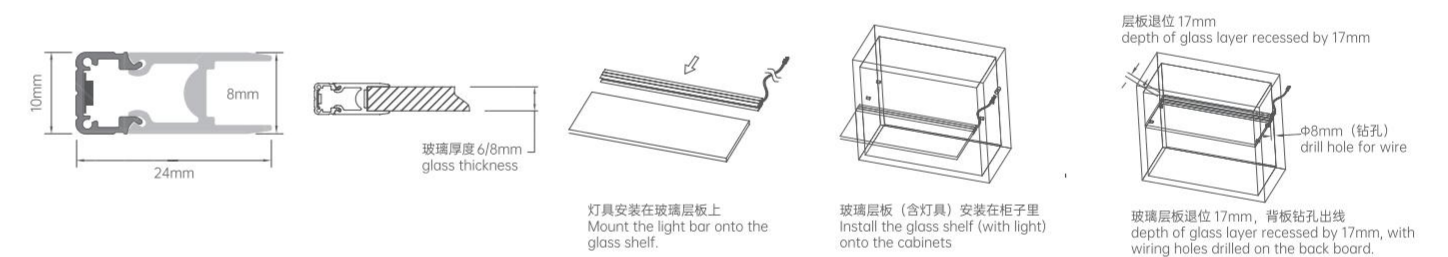

技术参数 TECHNICAL DETAILS

Color Temperature 色温 (K)	Item No. 型号	Highclass grey 太郎灰	Highclass grey 波尔多红 (定制)	Highclass grey 香槟金 (定制)	Size (mm) 尺寸 (mm)	Power 功率
可调 3 色温 (3000K-4000K-6000K) 通过智能控制盒实现 3 色温自由调节	12700053	12700051	12700052	500MM	5W	
	12700063	12700061	12700062	600MM	6W	
	12700073	12700071	12700072	700MM	7W	
	12700083	12700081	12700082	800MM	8W	
	12700093	12700091	12700092	900MM	9W	
	12700103	12700101	12700102	1000MM	10W	
	12700123	12700121	12700122	1200MM	12W	
	12700143	12700141	12700142	1400MM	14W	
	12700163	12700161	12700162	1600MM	16W	
	12700183	12700181	12700182	1800MM	18W	
3-color temperature adjustment available via a smart control box	12700203	12700201	12700202	2000MM	20W	
	12700223	12700221	12700222	2200MM	22W	
	12700243	12700241	12700242	2400MM	24W	
	12700303	12700301	12700302	3000MM	30W	

★ 电压：12VDC，连接方式：诺米免焊端子线（长度 1.5M，非标配，需单独下单）。NUOMI welding-free or two-in-one welding-free patch cords (1.5M, additional purchase is required).

FLEXIBLE LED LIGHTING STRIP

高端灯带

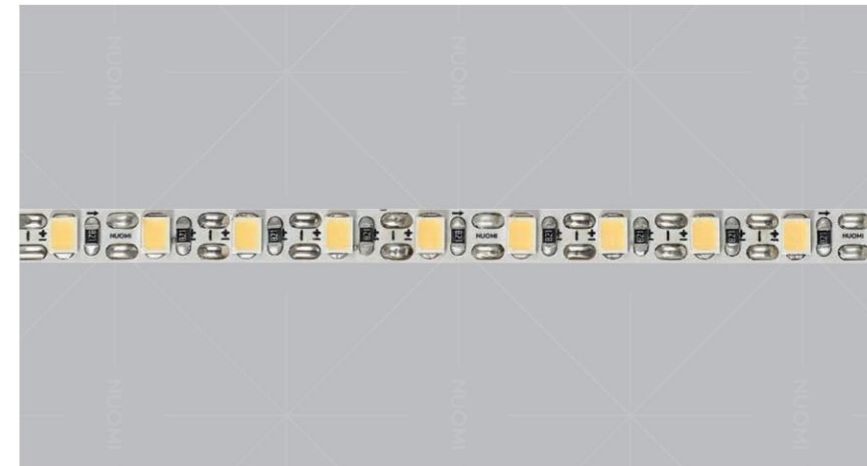

产品特点 FEATURES

- 采用优质芯片光源，双面软电路板，精益贴片，标准生产寿命 54000 小时
- 12V 供电，安全可靠
- 单色灯带 3000K-4000K-6000K 可选色温
- 显指 Ra>90
- Adopting high-quality chip light sources, double-sided flexible circuit board, precision SMT, standard production, with a lifespan of 54,000 hours.
- 12V power source, safe and stable.
- RA>90.

可选灯源色温 COLOR TEMPERATURE

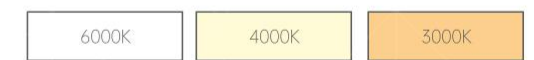

技术参数 TECHNICAL DETAILS

Product Name 产品名称	Item No. 型号	Size (mm) 规格 (mm)	parameter (mm) 参数 (mm)	Color Temperature 色温 (K)
高端单色灯带 3000K Single Color Temperature light strip	12243425	25M	120 灯珠 一灯一剪 120 chips, one chip per cut	3000K
高端单色灯带 4000K Single Color Temperature light strip	12244425	25M		4000K
高端三色灯带 3000K-4000K-6000K Triple Colors Temperature light strip	12240425	25M		3000K-4000K-6000K

FLEXIBLE LED LIGHTING STRIP

常规灯带

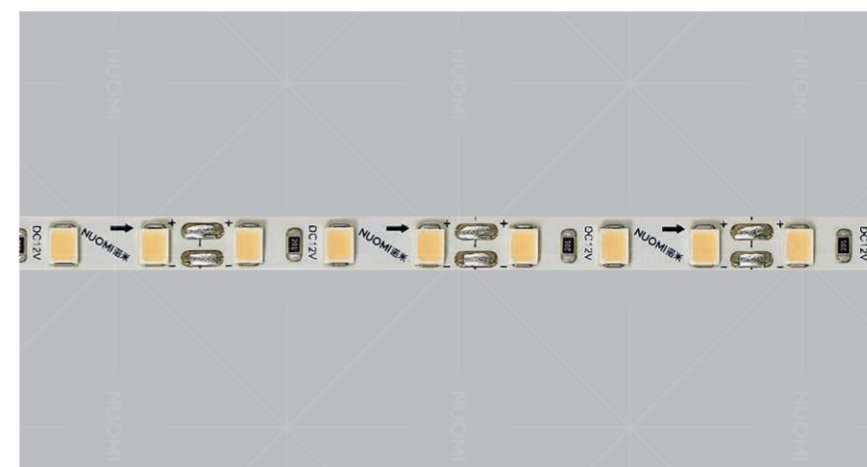

产品特点 FEATURES

- 采用优质芯片光源，双面软电路板，精益贴片，标准生产寿命 54000 小时
- 12V 供电，安全可靠
- 单色灯带 3000K-4000K-6000K 可选色温
- 显指 Ra>90
- Adopting high-quality chip light sources, double-sided flexible circuit board, precision SMT, standard production, with a lifespan of 54000 hours.
- 12V power source, safe and stable.
- RA>90.

可选灯源色温 COLOR TEMPERATURE



技术参数 TECHNICAL DETAILS

Product Name 产品名称	Item No. 型号	Size (mm) 规格 (mm)	parameter (mm) 参数 (mm)	Color Temperature 色温 (K)
单色灯带 3000K Single Color Temperature light strip	12243325	25M	120 灯珠 三灯一剪 120 chips, one chip per cut	3000K
单色灯带 4000K Single Color Temperature light strip	12244325	25M		4000K





内嵌式超窄灯条 -DIY 配件 BUILD-IN ULTRA-NARROW LIGHT BAR - DIY ACC.

Color Temperature 色温 (K)	Item No. 型号	Size (mm) 尺寸 (mm)	备注		
	Highclass grey 太郎灰	Bordeaux red 波尔多红 (定制)	Champagne golden 香槟金 (定制)		
铝型材 + 灯罩 Aluminum profile + cover	12710003	12710001	12710002	3000MM	/
堵头 End cap	12810003A	12810001A	12810002A	PC 材质 PC material	/
免焊堵头 Welding free cap	12810003B	12810001B	12810002B	PC 材质 PC material	/



明装后口上下发光灯条 -DIY 配件

Color Temperature 色温 (K)	Item No. 型号	Size (mm) 尺寸 (mm)	备注		
	Highclass grey 太郎灰	Bordeaux red 波尔多红 (定制)	Champagne golden 香槟金 (定制)		
铝型材 + 灯罩 Aluminum profile + cover	12740003	12740001	12740002	3000MM	/
左堵头 Left end cap	12850003A	12850001A	12850002A	PC 材质 PC material	与 1286 共用 Shared with 1286
免焊右堵头 Welding free rightend cap	12850003B	12850001B	12850002B	PC 材质 PC material	与 1286 共用 Shared with 1286



嵌入式斜射灯条 -DIY 配件 BUILD-IN OBLIQUE LIGHT BAR - DIY ACC.

Color Temperature 色温 (K)	Item No. 型号	Size (mm) 尺寸 (mm)	备注		
	Highclass grey 太郎灰	Bordeaux red 波尔多红 (定制)	Champagne golden 香槟金 (定制)		
铝型材 + 灯罩 Aluminum profile + cover	12720003	12720001	12720002	3000MM	/
堵头 End cap	12820003A	12820001A	12820002A	PC 材质 PC material	与 1283 共用 Shared with 1283
免焊堵头 Welding free cap	12820003B	12820001B	12820002B	PC 材质 PC material	与 1283 共用 Shared with 1283



明装后口下发光灯条 -DIY 配件

Color Temperature 色温 (K)	Item No. 型号	Size (mm) 尺寸 (mm)	备注		
	Highclass grey 太郎灰	Bordeaux red 波尔多红 (定制)	Champagne golden 香槟金 (定制)		
铝型材 + 灯罩 Aluminum profile + cover	12750003	12750001	12750002	3000MM	/
左堵头 Left end cap	12850003A	12850001A	12850002A	PC 材质 PC material	与 1285 共用 Shared with 1285
免焊右堵头 Welding free rightend cap	12850003B	12850001B	12850002B	PC 材质 PC material	与 1285 共用 Shared with 1285



嵌入式灯条 (铝材翻边) -DIY 配件 BUILT-IN LIGHT BAR (FLANGED ALUMINUM) - DIY ACC.

Color Temperature 色温 (K)	Item No. 型号	Size (mm) 尺寸 (mm)	备注		
	Highclass grey 太郎灰	Bordeaux red 波尔多红 (定制)	Champagne golden 香槟金 (定制)		
铝型材 + 灯罩 Aluminum profile + cover	12730003	12730001	12730002	3000MM	/
堵头 End cap	12820003A	12820001A	12820002A	PC 材质 PC material	与 1282 共用 Shared with 1282
免焊堵头 Welding free cap	12820003B	12820001B	12820002B	PC 材质 PC material	与 1282 共用 Shared with 1282

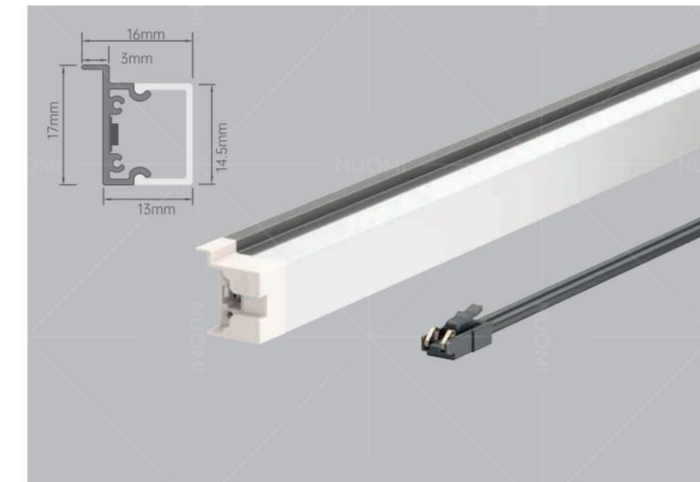

免安装后口层板灯 -DIY 配件

Color Temperature 色温 (K)	Item No. 型号	Size (mm) 尺寸 (mm)	备注		
	Highclass grey 太郎灰	Bordeaux red 波尔多红 (定制)	Champagne golden 香槟金 (定制)		
铝型材 + 灯罩 Aluminum profile + cover	12730003	12730001	12730001	3000MM	/
左堵头 Left end cap	12873001B	12873001B	12873001B	乳白色 White	/
免焊右堵头 Welding free rightend cap	12873001A	12873001A	12873001A	乳白色 White	/

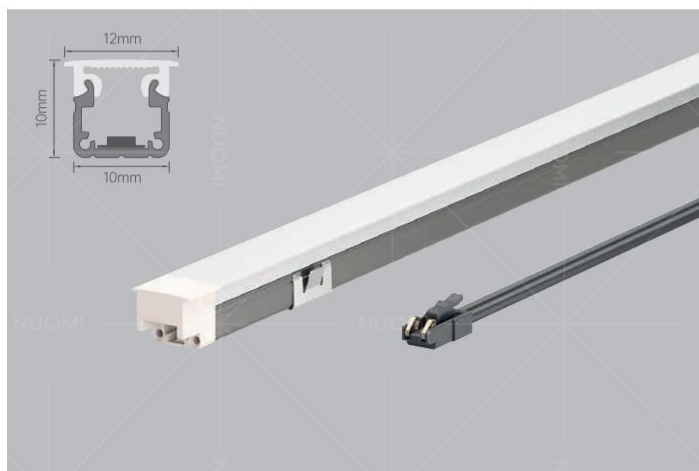

嵌入式灯条 (灯罩翻边) -DIY 配件 BUILT-IN LIGHT BAR (FLANGED LAMP SHADE) - DIY ACC.

Color Temperature 色温 (K)	Item No. 型号	Size (mm) 尺寸 (mm)	备注		
	Highclass grey 太郎灰	Bordeaux red 波尔多红 (定制)	Champagne golden 香槟金 (定制)		
铝型材 + 灯罩 Aluminum profile + cover	12790003	12790001	12790002	3000MM	/
免焊堵头 Welding free cap	12843001A	12843001A	12843001A	乳白色 White	/



玻璃层板灯条 -DIY 配件

Color Temperature 色温 (K)	Item No. 型号	Size (mm) 尺寸 (mm)	备注		
	Highclass grey 太郎灰	Bordeaux red 波尔多红 (定制)	Champagne golden 香槟金 (定制)		
铝型材 + 灯罩 Aluminum profile + cover	12700003	12700001	12700002	3000MM	/
免焊堵头 Welding free cap	12883001A	12883001A	12883001A	乳白色 White	/



ARES LIGHT

阿瑞斯系列

Clean and comfortable space, more full and orderly combination of different modules, breaking the monotony of the plane, bringing rhythm and rhythm is more undulating.

干净而舒适的空间，不同模块组合更显饱满有序，突破了平面的单调，带来更具起伏的韵律与节奏。



BRIGHT AND ELEGANT



ARES LIGHT

- Minimalism ultra narrow strip lights, follow current trend, minimalism light luxury style.
- Ultra narrow luminous surface area 5.8mm.
- High quality pc lampshade, uv resistant, lighting balance, soft for eyes.

阿瑞斯系列

- 迎合当下流行的极简轻奢风格需要的极简超窄灯条;
- 极简超窄发光面低至 5.8mm, 行业极窄;
- 抗 UV 高品质 PC 灯罩, 光线均匀无晶点, 柔和不刺眼。



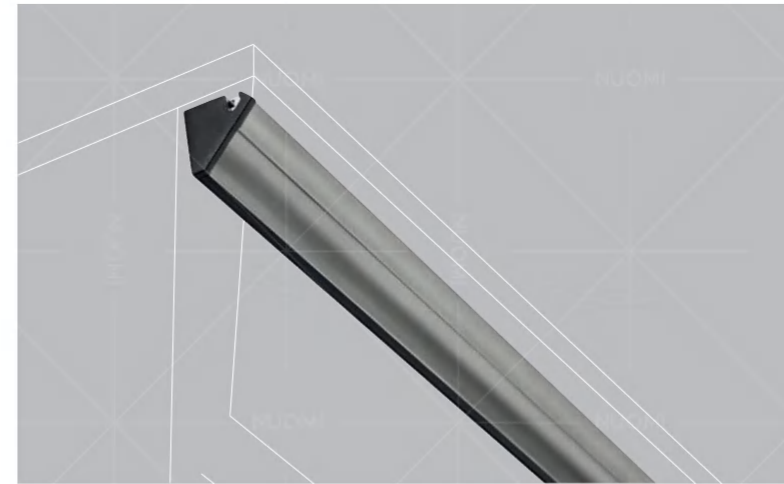

产品特点 FEATURES

- 采用高品质 LED 光源，可调或可选色温（3000K、4000K、6000K），可调亮度，出光均匀，54000 小时超长寿命；
- 用于层板后口安装，见光不见灯，光效柔和，可裁切；
- 超窄设计 PC 灯罩，无晶点；
- 显指 Ra>90。
- High-quality LED light sources, with adjustable or selectable color temperature (3000K, 4000K, 6000K) and brightness, ensuring uniform illumination and an ultra-long lifespan of 54000hours.
- Suitable for installation behind layer boards, providing soft and even lighting without directly visible light, flexible cutting.
- Features an ultra-narrow design PC lampshade without visible dots.
- Ra>90.

可调灯源色温 ADJUSTABLE COLOR TEMPERATURE



安装说明 INSTALLATION INSTRUCTIONS

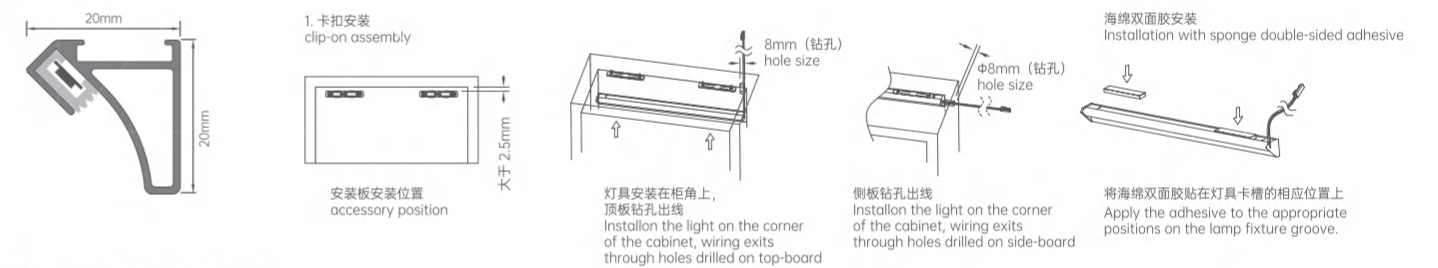

技术参数 TECHNICAL DETAILS

Color Temperature 色温 (K)	Item No. 型号	Size (mm) 尺寸 (mm)	Power 功率	Remark 备注	
可调色温 Adjustable Color Temperature (3000K、4000K、6000K)	Highclass grey 太郎灰	Matte black 哑黑			
	12360043	12360045	400mm	4W	
	12360063	12360065	600mm	6W	
	12360083	12360085	800mm	8W	
	12360103	12360105	1000mm	10W	
	12360123	12360125	1200mm	12W	
	12360153	12360155	1500mm	15W	两端焊线配两个堵头两个底座 Two end wires with two end caps and two bases.
	12360183	12360185	1800mm	18W	
	12360283	12360285	2800mm	28W	
	3000K	12363043	12363045	400mm	4W
12363063		12363065	600mm	6W	
12363083		12363085	800mm	8W	
12363103		12363105	1000mm	10W	
12363123		12363125	1200mm	12W	
12363153		12363155	1500mm	15W	两端焊线配两个堵头两个底座 Two end wires with two end caps and two bases.
12363183		12363185	1800mm	18W	
12363283		12363285	2800mm	28W	
4000K		12364043	12364045	400mm	4W
		12364063	12364065	600mm	6W
	12364083	12364085	800mm	8W	
	12364103	12364105	1000mm	10W	
	12364123	12364125	1200mm	12W	
	12364153	12364155	1500mm	15W	两端焊线配两个堵头两个底座 Two end wires with two end caps and two bases.
	12364183	12364185	1800mm	18W	
	12364283	12364285	2800mm	28W	
同上	12369991	波尔多红 bordeaux red	/	/	定制 custom size
同上	12369992	香槟金 champagne gold	/	/	定制 custom size

★ 电压: 12VDC, 连接方式: 超薄导线 Ultra-thin wire (0.6M) + 延长线 Extension wire (2M) .



产品特点 FEATURES

- 采用高品质 LED 光源，可调或可选色温（3000K、4000K、6000K），可调亮度，出光均匀，54000 小时超长寿命；
- 向内发光，见光不见灯，光效柔和，可裁切；
- 超窄设计 PC 灯罩，无晶点；
- 显指 Ra>90。
- High-quality LED light sources, with adjustable or selectable color temperature (3000K, 4000K, 6000K) and brightness, ensuring uniform illumination and an ultra-long lifespan of 54000 hours.
- Suitable for installation behind layer boards, providing soft and even lighting without directly visible light, flexible cutting.
- Features an ultra-narrow design PC lampshade without visible dots.
- Ra>90.

可调灯源色温 ADJUSTABLE COLOR TEMPERATURE

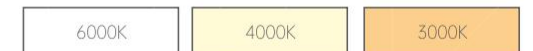

安装说明 INSTALLATION INSTRUCTIONS

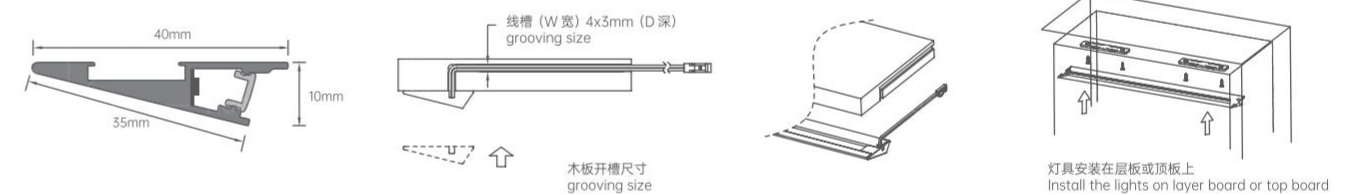

技术参数 TECHNICAL DETAILS

Color Temperature 色温 (K)	Item No. 型号	Size (mm) 尺寸 (mm)	Power 功率	Remark 备注	
可调色温 Adjustable Color Temperature (3000K、4000K、6000K)	Highclass grey 太郎灰	Matte black 哑黑			
	12330043	12330045	400mm	4W	
	12330063	12330065	600mm	6W	
	12330083	12330085	800mm	8W	
	12330103	12330105	1000mm	10W	
	12330123	12330125	1200mm	12W	
	12330153	12330155	1500mm	15W	
	12330183	12330185	1800mm	18W	
	12330283	12330285	2800mm	28W	
	12333043	12333045	400mm	4W	
3000K	12333063	12333065	600mm	6W	
	12333083	12333085	800mm	8W	
	12333103	12333105	1000mm	10W	
	12333123	12333125	1200mm	12W	
	12333153	12333155	1500mm	15W	
	12333183	12333185	1800mm	18W	
	12333283	12333285	2800mm	28W	
	12334043	12334045	400mm	4W	
	12334063	12334065	600mm	6W	
	12334083	12334085	800mm	8W	
4000K	12334103	12334105	1000mm	10W	
	12334123	12334125	1200mm	12W	
	12334153	12334155	1500mm	15W	
	12334183	12334185	1800mm	18W	
	12334283	12334285	2800mm	28W	
	12334153	12334155	1500mm	15W	
同上	12339991	波尔多红 bordeaux red	/	/	定制 custom size
同上	12339992	香槟金 champagne gold	/	/	定制 custom size

★ 电压：12VDC，连接方式：杜邦端子线（1.5M）。Dupont wire（1.5M）。

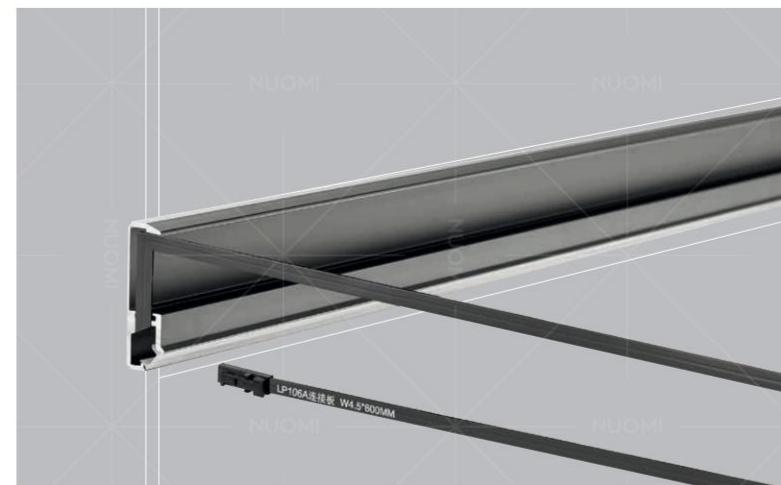

产品特点 FEATURES

- 采用高品质 LED 光源，可调或可选色温（3000K、4000K、6000K），可调亮度，出光均匀，54000 小时超长寿命；
- 标配超薄导线，走线不再钻孔外露，可裁切；
- 超薄设计 PC 灯罩，无晶点；
- 显指 Ra>90。
- Adopting high-quality LED light sources, with adjustable or selectable color temperature (3000K, 4000K, 6000K) and brightness, ensuring uniform illumination and an ultra-long lifespan of 54000 hours;
- Emitting light inward, providing soft and even lighting without direct visibility of the light source, flexible cutting.
- Features an ultra-narrow design PC lampshade without visible dots.
- Ra>90.

可调灯源色温 ADJUSTABLE COLOR TEMPERATURE



安装说明 INSTALLATION INSTRUCTIONS

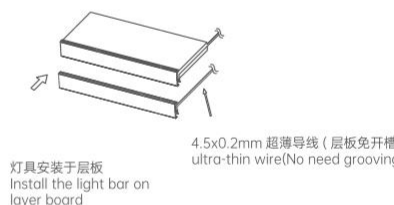
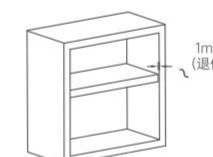
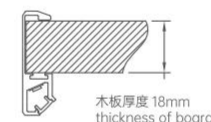
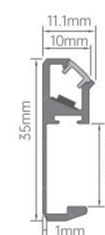

技术参数 TECHNICAL DETAILS

Color Temperature 色温 (K)	Item No. 型号		Size (mm) 尺寸 (mm)	Power 功率	Remark 备注
可调色温 Adjustable Color Temperature (3000K、4000K、6000K)	Highclass grey 太郎灰	Matte black 哑黑			
	12370043	12370045	400mm	4W	
	12370063	12370065	600mm	6W	
	12370083	12370085	800mm	8W	
	12370103	12370105	1000mm	10W	
3000K	12370123	12370125	1200mm	12W	两端焊线 both ends bonding wire
	12373043	12373045	400mm	4W	
	12373063	12373065	600mm	6W	
	12373083	12373085	800mm	8W	
	12373103	12373105	1000mm	10W	
4000K	12373123	12373125	1200mm	12W	两端焊线 both ends bonding wire
	12374043	12374045	400mm	4W	
	12374063	12374065	600mm	6W	
	12374083	12374085	800mm	8W	
	12374103	12374105	1000mm	10W	
	12374123	12374125	1200mm	12W	两端焊线 both ends bonding wire
同上	12379991	波尔多红 bordeaux red	/	/	定制 custom size
同上	12379992	香槟金 champagne gold	/	/	定制 custom size

★ 电压: 12VDC, 连接方式: 超薄导线 Ultra-thin wire (0.6M) + 延长线 Lengthen wire (2M) .



SENSORY LIGHT

感应式灯光



The design is human-centric, with beautiful lines that can be easily integrated into different styles of home life, easily control any space, and restore the purity and beauty of life.

设计以人为核心，富有美感的线条，
能够轻易融入不同风格的家居生活之中，轻松驾驭任意空间，
还原生活的纯粹与美好。



Convenient wireless installation, no worries about wiring. A variety of inductive switching methods improve all inconveniences and open up a more flexible home life for you.

便捷无线安装, 无走线顾虑。多种感应开关方式, 改善一切不便, 为你打开更灵活的居家生活。





产品特点 FEATURES

- 采用高品质 LED 光源, 可选色温 (4000K), 可调亮度, 出光均匀, 54000 小时超长寿命;
- 超长续航, 磁吸 / 卡扣安装, 门控感应;
- 采用日本进口三菱导光板, 出光均匀无光斑;
- 左右门控感应开关, 便于左右安装;
- 显指 Ra>90。
- High-quality LED light sources, optional color temperature (4000k), adjustable brightness, ultra-long lifespan of 54,000 hours.
- Long-lasting battery life, magnetic/snap-on installation, door sensor activation.
- LGP imported from mitsubishi, uniform illumination.
- Double door-control switch (left and right).
- Ra>90.

可选光源色温 COLOR TEMPERATURE

4000K

安装说明 INSTALLATION INSTRUCTIONS

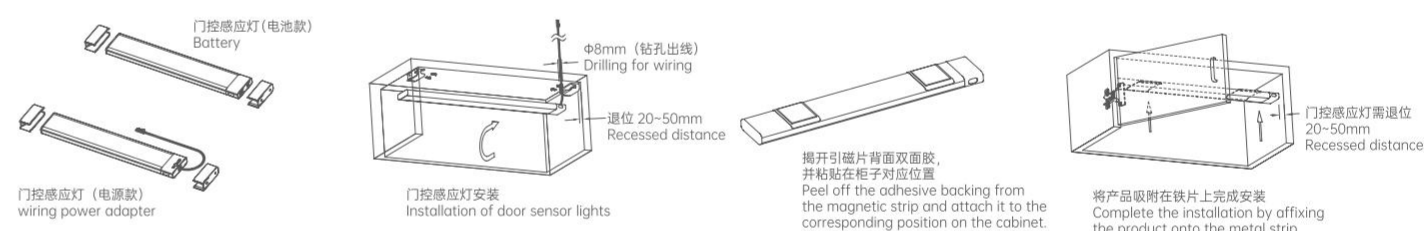

技术参数 TECHNICAL DETAILS

Color Temperature 色温 (K)	Product Name 产品名称	Item No. 型号	Size (mm) 尺寸 (mm)	Power 功率	Sensor switch 感应开关	
4000K	电池款门控感应灯 Battery type	Champagne golden 香槟金	Highclass grey 太郎灰	Matte black 哑黑		
		12534042	12534043	12534045	413mm	1.8W
		12534062	12534063	12534065	563mm	2.4W
		12534072	12534073	12534075	663mm	2.8W
		12534082	12534083	12534085	763mm	3.2W
	12534092	12534093	12534095	863mm	3.6W	
	电源款门控感应灯 Battery type	12544042	12544043	12544045	413mm	4.5W
		12544062	12544063	12544065	563mm	6W
		12544072	12544073	12544075	663mm	7W
		12544082	12544083	12544085	763mm	8W
12544092		12544093	12544095	863mm	9W	

★ 电压: 5VDC (电池款) / 12VDC (电源款), 连接方式: 电池供电 (电池款) / 杜邦端子线 (1.5M) 。 Dupont wire (1.5M) 。



产品特点 FEATURES

- 采用高品质 LED 光源，可调色温（3000K、4000K、6000K）、亮度，出光均匀，54000 小时超长寿命；
- 磁吸便捷安装，手扫感应，随手取下当夜灯；
- 采用日本进口三菱导光板，出光均匀无光斑；
- 显指 Ra>90。
- High-quality LED lightsources , optional color temperature (3000K/4000k/6000K), adjustable brightness, ultra-long lifespan of 54,000 hours.
- Convenient magnetic installation, hand-sweep sensor activation, easily detachable for use as a night light.
- LGP imported from mitsubishi, uniform illumination.
- Double door-control switch (left and right).
- Ra>90.

可调灯源色温 COLOR TEMPERATURE ADJUSTABLE

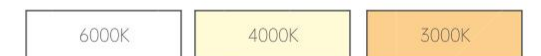

安装说明 INSTALLATION INSTRUCTIONS

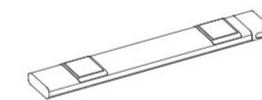

揭开引磁片背面双面胶，并粘贴在柜子对应位置
Peel off the adhesive backing from the magnetic strip and attach it to the corresponding position on the cabinet.

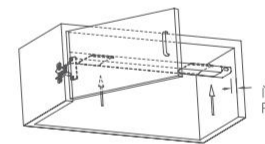

将产品吸附在铁片上完成安装
Complete the installation by affixing the product onto the metal strip

门控感应灯需错位 20-50mm
Recessed distance

技术参数 TECHNICAL DETAILS

Color Temperature 色温 (K)	Item No. 型号		Size (mm) 尺寸 (mm)	Power 功率	Sensor switch 感应开关
	Champagne golden 香槟金	Highclass grey 太郎灰	Matte black 哑黑		
可调色温 Adjustable Color Temperature(3000K, 4000K、6000K)	12550032	12550033	12550035	300mm	1.2W
	12550052	12550053	12550055	500mm	2W
	12550082	12550083	12550085	800mm	3.2W
					带手扫感应开关 hand sweep sensor switch

★ 电压：5VDC（电池款）/12VDC（电源款），连接方式：电池供电（电池款）/杜邦端子线（1.5M）Dupont wire（1.5M）



产品特点 FEATURES

- 采用高品质 LED 光源, 可选色温 (4000K), 可调亮度, 出光均匀, 54000 小时超长寿命;
- 磁吸便捷安装, 人体感应, 随手取下当夜灯;
- 采用日本进口三菱导光板, 出光均匀无光斑;
- 感应距离 3 米, 延时输出 30 秒;
- 显指 Ra>90。
- High-quality LED light sources , optional color temperature (3000K/4000k/6000K), adjustable brightness, ultra -long lifespan of 54,000 hours.
- Convenient magnetic installation, hand-sweep sensor activation, easily detachable for use as a night light.
- LGP imported from mitsubishi, uniform illumination.
- Sensor distance of 3 meters, with a delay output of 30 seconds
- Ra>90.

可选灯源色温 COLOR TEMPERATURE

4000K

安装说明 INSTALLATION INSTRUCTIONS

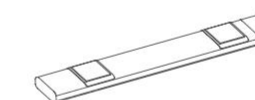
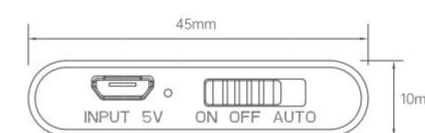

揭开引磁片背面双面胶, 并粘贴在柜子对应位置
Peel off the adhesive backing from the magnetic strip and attach it to the corresponding position on the cabinet.

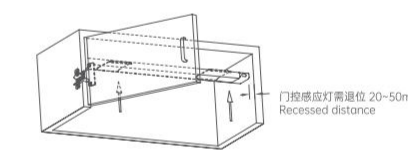

将产品吸附在铁片上完成安装
Complete the installation by affixing the product onto the metal strip

技术参数 TECHNICAL DETAILS

Color Temperature 色温 (K)	Item No. 型号		Size (mm) 尺寸 (mm)	Power 功率	Sensor switch 感应开关	
4000K	Champagne golden 香槟金	Highclass grey 太郎灰	Matte black 哑黑			
	12564032	12564033	12550035	300mm	1.2W	
	12564052	12564053	12550055	500mm	2W	
	12564082	12564083	12550085	800mm	3.2W	
						人体红外感应开关 body infraredsensor switch

★ 电压: 5VDC, 连接方式: 电池供电。battery power supply.



COMMON SERIES

常规系列



The texture of the material is mapped to the warm and natural beauty, giving the space a natural stretch and relaxation, bringing a more comfortable life experience.

材质的肌理被映射出温煦的自然美感，让空间多了一份自然的舒展与放松，带来更为舒适的生活体验。



产品特点 FEATURES

- 采用高品质 LED 光源, 可选色温 (3000K、4000K) 亮度, 出光均匀, 54000 小时超长寿命;
- 用作橱柜、衣柜踢脚板, 向下发光, 见光不见灯, 可裁切;
- 防水灯条;
- 显指 Ra>90。
- High-quality LED light sources, with adjustable or selectable color temperature (3000K, 4000K, 6000K) and brightness, ensuring uniform illumination and an ultra-long lifespan of 54,000 hours.
- Used for cabinet and wardrobe kickboards, downward illumination, hidden light source, flexible cutting.
- Waterproof.
- Ra>90.

可选灯源色温 COLOR TEMPERATURE ADJUSTABLE

4000K

3000K

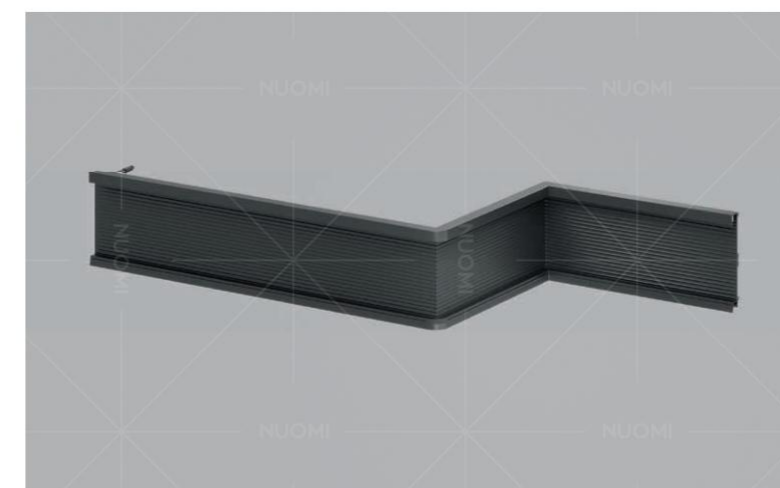

安装说明 INSTALLATION INSTRUCTIONS

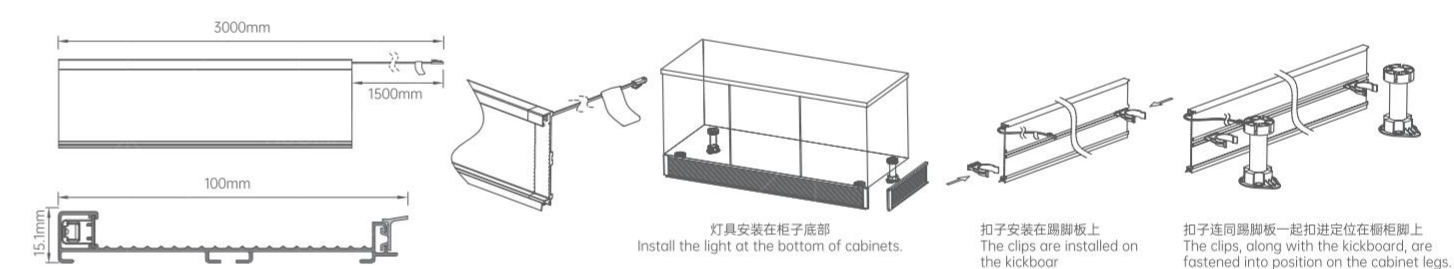

技术参数 TECHNICAL DETAILS

Color Temperature 色温 (K)	Item No. 型号			Size (mm) 尺寸 (mm)	Power 功率	Remark 备注	Sensor switch 感应开关
	Highclass grey 太郎灰	Highclass grey 波尔多红 (定制)	Champagne gold 香槟金 (定制)				
3000K	12943303	12943301	12943302	3000mm	10W/m 米	每包 10 根, 默认免焊 右出线, 阴转角、阳转 角、平接, 各 1 个 Each pack contains 10 pcs, defaulting to solder-free right output. Includes one each of inner corner, outer corner, and straight connection	无感应开关 (可外接) no sensor switch (external available)
4000K	12944303	12944301	12944302	3000mm	10W/m 米		
/	12940003C	12940001C	12940002C	/	/	踢脚板灯配件套装 Kickboard light accessory pack	无感应开关 (可外接) no sensor switch (external available)

★ 电压: 12VDC, 连接方式: 杜邦端子线 (1.5M)。Dupont wire (1.5M)。



产品特点 FEATURES

- 采用高品质 LED 光源, 可调色温 (3000K、4000K、6000K)、亮度, 出光均匀, 54000 小时超长寿命;
 - 超薄设计, 灯与层板无缝隙完美融合, 嵌入式简易安装, 开孔直径为 62MM;
 - 底座明装, 无需开孔;
 - 外观精致美观;
 - 显指 Ra>90。
- High-quality LED light sources, with adjustable or selectable color temperature (3000K, 4000K, 6000K) and brightness, ensuring uniform illumination and an ultra-long lifespan of 54,000 hours.
 - Ultra-thin design, built-in mounted, hole drilling diameter is 62mm.
 - No need drilling hole, surface mounted.
 - Ra>90.

可调灯源色温 ADJUSTABLE COLOR TEMPERATURE

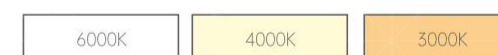

嵌入式圆形射灯 BUILT-IN ROUND SPOTLIGHT

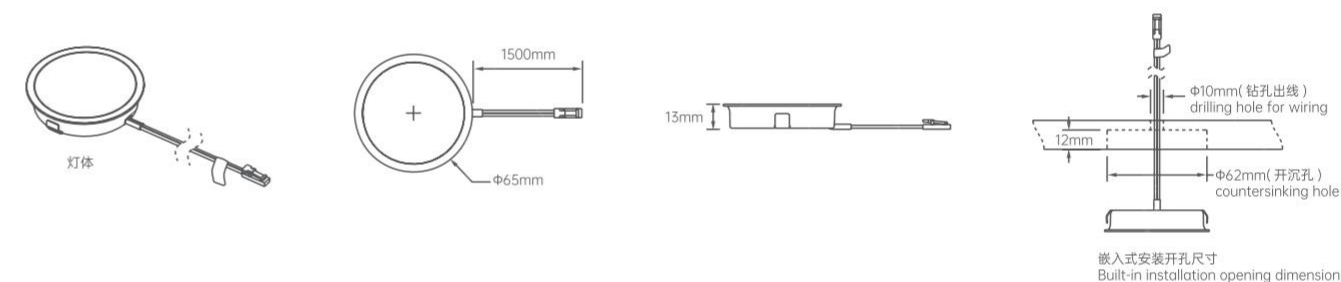

技术参数 TECHNICAL DETAILS

Color Temperature 色温 (K)	Item No. 型号	Aluminium color 铝材颜色	Size (mm) 尺寸 (mm)	Power 功率	Sensor switch 感应开关
可调色温 (3000K、4000K、6000K)	12660018	哑银 silver	φ 64.5xH13	2W	无感应开关 (可外接) no sensor switch (external available)

明装圆形射灯外壳 SURFACE MOUNTED ROUND SPOTLIGHT

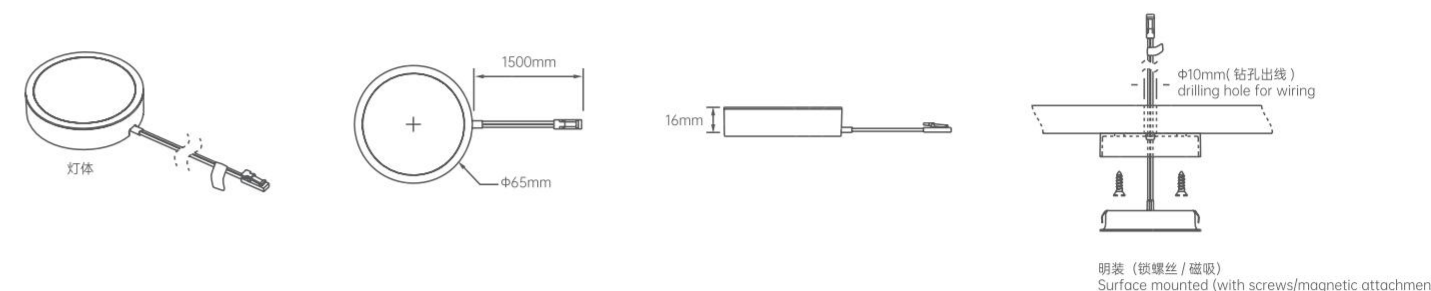

技术参数 TECHNICAL DETAILS

Color Temperature 色温 (K)	Item No. 型号	Aluminium color 铝材颜色	Size (mm) 尺寸 (mm)	Power 功率	Sensor switch 感应开关
可调色温 (3000K、4000K、6000K)	12660028	哑银 silver	φ 64.5xH13	2W	无感应开关 (可外接) no sensor switch (external available)

★ 电压: 12VDC, 连接方式: 杜邦端子线 (1.5M) 。Dupont wire (1.5M) .



产品特点 FEATURES

- 采用高品质 LED 光源，可调或可选色温（3000K、4000K、6000K），可调亮度，出光均匀，54000 小时超长寿命；
- 12V 供电，安全可靠，可裁切；
- 双色灯带 3000K-4000K-6000k 可调色温；
- 显指 Ra>90。
- High-quality LED light sources, with adjustable or selectable color temperature (3000K, 4000K, 6000K) and brightness, ensuring uniform illumination and an ultra-long lifespan of 54,000 hours.
- 12V power source, safe and stable.
- Dual-color light strip with adjustable color temperature of 3000K-4000K-6000K.
- Ra>90.

可调灯源色温 ADJUSTABLE COLOR TEMPERATURE

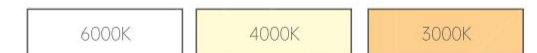

安装说明 INSTALLATION INSTRUCTIONS

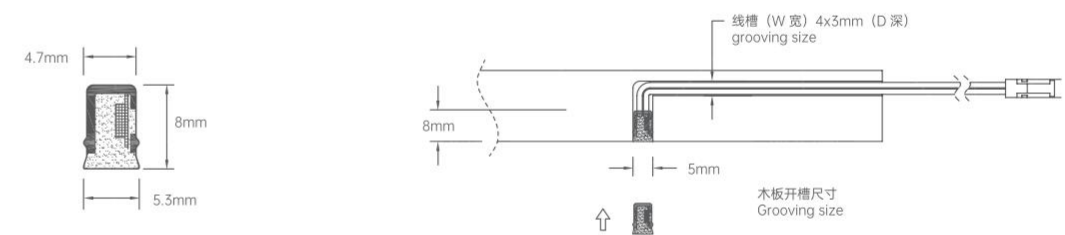

技术参数 TECHNICAL DETAILS

Color Temperature 色温 (K)	Item No. 型号	Size (mm) 尺寸 (mm)	Power 功率	Remark 备注	Sensor switch 感应开关
可调色温 (3000K、4000K、6000K)	12670049	400mm	4W		
	12670069	600mm	6W		
	12670089	800mm	8W		
	12670109	1000mm	10W		无感应开关 (可外接) no sensor switch (external available)
	12670129	1200mm	12W		
	12670289	2800mm	28W	两端焊线 both ends bonding wire	
3000K	12670509	5000mm	50W		
	12673049	400mm	4W		
	12673069	600mm	6W		
	12673089	800mm	8W		
	12673109	1000mm	10W		无感应开关 (可外接) no sensor switch (external available)
	12673129	1200mm	12W		
4000K	12673289	2800mm	28W	两端焊线 both ends bonding wire	
	12673509	5000mm	50W		
	12674049	400mm	4W		
	12674069	600mm	6W		
	12674089	800mm	8W		
	12674109	1000mm	10W		无感应开关 (可外接) no sensor switch (external available)
	12674129	1200mm	12W		
	12674289	2800mm	28W	两端焊线 both ends bonding wire	
	12674509	5000mm	50W		

★ 电压: 12VDC, 连接方式: 杜邦端子线 (1.5M) 。Dupont wire (1.5M) .

SMART CONTROL SYSTEM AND ACCESSORIES

智能控制系统及配件



Convenient wireless installation, support wireless touch sensing, wireless human body sensing, wireless door control or hand sweep (integrated switchable) sensing, etc. Master the core technology, create an intelligent living space, let you enjoy a convenient life.

便捷无线安装，支持无线触摸感应、无线人体感应、无线门控或手扫（集成可切换）感应等。核心科技傍身，打造智能化生活空间，让你悦享便捷人生。

ULTRA-THIN CONSTANT VOLTAGE POWER SOURCE WITH SMART CONTROL

高端 LED 智能超薄恒压电源



产品特点 FEATURES

- 产品通过 CCC 认证, 符合 UL、CE、KC 等相关标准及美国能源之星 - 固态照明 SSL 灯具之要求;
- 安全, 系统具有轻载, 过载保护功能, 确保电源工作稳定, 电源有较高的效率, 发热小, 元器件采用品牌器件, 质量稳定;
- 抗干扰和抗过载能力强;
- 可搭配无线开关使用, 可调色温, 亮度;
- 16.5mm 超薄设计, 空间利用更充沛。

- 3C certificate, meet UL, CE, KC standard.
- Overload protection, stable power supply.
- Strong anti-interference capability.
- Standard equipped with wireless receiver, capable for wireless switch, adjusting color temperature and brilliance.
- 16.5mm thickness, ultra-thin.

安装说明 INSTALLATION INSTRUCTIONS

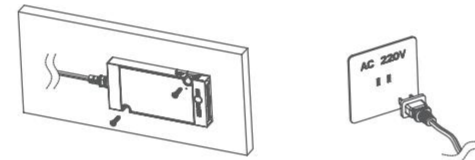

建议此恒压控制装置用螺丝固定在柜体或墙壁上
fix the power adapter on the cabinet board or wall

接 220V 电源
connect to 220V power source

技术参数 TECHNICAL DETAILS

Item No. 型号	Size (mm) 尺寸 (mm)	Color 颜色	Ac Input 交流输入	Voltage Output 电压输出	Power 功率	output control mode 输出控制方式
12204024	L100xW68xH16.5mm	湖蓝色 blue	200-240Vac~0.2A Max 50/60HZ PF>0.9	12V/2A	24W	有线或无线 wire or wireless
12204036	L140xW68xH16.5mm	湖蓝色 blue	200-240Vac~0.3A Max 50/60HZ PF>0.9	12V/3A	36W	
12204065	L160xW68xH16.5mm	湖蓝色 blue	200-240Vac~0.5A Max 50/60HZ PF>0.9	12V/5.4A	65W	
12204090	L215xW68xH16.5mm	湖蓝色 blue	200-240Vac~0.8A Max 50/60HZ PF>0.9	12V/7.5A	90W	

ULTRA-THIN CONSTANT VOLTAGE POWER SOURCE WITH SMART CONTROL

LED 智能超薄恒压电源



产品特点 FEATURES

- 安全, 系统具有轻载, 过载保护功能, 确保电源工作稳定, 电源有较高的效率, 发热小, 元器件采用品牌器件, 质量稳定;
- 结构简单, 无众多的元器件, 可靠性相当高稳压范围相当宽, 抗干扰和抗过载能力强;
- 16.5mm 超薄设计, 空间利用更充沛。

- Overload protection, stable power supply.
- Strong anti-interference capability.
- 16.5mm thickness, ultra-thin.

安装说明 INSTALLATION INSTRUCTIONS

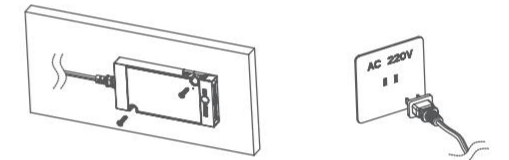

建议此恒压控制装置用螺丝固定在柜体或墙壁上
fix the power adapter on the cabinet board or wall

接 220V 电源
connect to 220V power source

技术参数 TECHNICAL DETAILS

Item No. 型号	Size (mm) 尺寸 (mm)	Ccolor 颜色	Ac Input 交流输入	Voltage Output 电压输出	Power 功率	output control mode 输出控制方式
12202024X	L100xW68xH16.5mm	黑色 Black	200-240Vac~0.2A Max 50/60HZ PF>0.9	12V/2A	24W	有线或无线 wire or wireless
12202036X	L140xW68xH16.5mm	黑色 Black	200-240Vac~0.45A Max 50/60HZ PF>0.9	12V/3A	36W	
12202060X	L160xW68xH16.5mm	黑色 Black	200-240Vac~0.7A Max 50/60HZ PF>0.9	12V/5A	60W	
12202100X	L215xW68xH16.5mm	黑色 Black	200-240Vac~1.1A Max 50/60HZ PF>0.9	12V/8.33A	100W	

ULTRA-THIN CONSTANT VOLTAGE POWER SOURCE WITH SMART CONTROL

LED 出口智能超薄恒压电源



产品特点 FEATURES

- 安全, 系统具有轻载, 过载保护功能, 确保电源工作稳定, 电源有较高的效率, 发热小, 元器件采用品牌器件, 质量稳定;
- 结构简单, 无众多的元器件, 可靠性相当高稳压范围相当宽, 抗干扰和抗过载能力强;
- 16.5mm 超薄设计, 空间利用更充沛。

- Overload protection, stable power supply.
- Strong anti-interference capability.
- 16.5mm thickness, ultra-thin.

安装说明 INSTALLATION INSTRUCTIONS

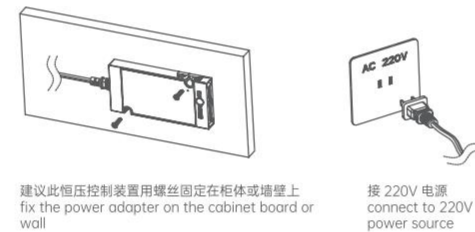

建议此恒压控制装置用螺丝固定在柜体或墙壁上
fix the power adapter on the cabinet board or wall

接 220V 电源
connect to 220V power source

技术参数 TECHNICAL DETAILS

Item No. 型号	Size (mm) 尺寸 (mm)	Ccolor 颜色	Ac Input 交流输入	Voltage Output 电压输出	Power 功率	output control mode 输出控制方式
12211260	L160xW68xH16.5mm	黑色 Black	200-240V~50/60HZ	12V 5A	60W	有线或无线 wire or wireless
12212460	L160xW68xH16.5mm	黑色 Black	200-240V~50/60HZ	24V 2.5A	60W	
SNL12211260	L160xW68xH16.5mm	黑色 Black	100-240V~50/60HZ	12V 5A	60W	
SNL12212460	L160xW68xH16.5mm	黑色 Black	100-240V~50/60HZ	24V 2.5A	60W	
SNL1220-60W	L160xW68xH16.5mm	黑色 Black	200-240V~50/60HZ	12V 5A	60W	
SNL1221-60W	L160xW68xH16.5mm	黑色 Black	200-240V~50/60HZ	24V 2.5A	60W	

★ 输出电压可定制 24V, 功率可定制 24W/36W, 不备库存。Customizable output 24V and power 24W/36W, non-stock.

WIRELESS TOUCH SENSOR SIGNAL SWITCH

无线触摸感应信号开关 (升级版本)



产品特点 FEATURES

- 无需布线, 便捷安装;
- 365 天超长续航, 纽扣电池简单更换;
- 触摸发射信号实现无线操控;
- 符合安全, 环保 RoHS。

- Wireless.
- Over 365 days ultra-long life battery, easy to assemble.
- Touch control, wireless.
- Safe and stable, meet standard of RoHS.

安装说明 INSTALLATION INSTRUCTIONS



技术参数 TECHNICAL DETAILS

Item No. 型号	12221001
Size (mm) 尺寸	50×47×14mm
Input voltage 输入电压	3VDC
Standby current 待机电流	3-10UA
Sensing distance 感应方式	电容式触摸 Capacitive touch
Signal induction 信号距离	5m
Installation 安装方式	明装 / 嵌装 Surface mounted / Built-in

WIRELESS HUMAN BODY INFRARED SENSOR SWITCH

圆形无线人体红外感应开关 (升级版本)



产品特点 FEATURES

- 无需布线, 便捷安装;
- 365 天超长续航, 纽扣电池简单更换;
- 人体感应发射信号, 实现无线操控;
- 10 米内按开关键遥控灯光亮度及色温;
- 符合安全, 环保 RoHS。

- Wireless.
- Over 365 days ultra-long life battery, easy to assemble.
- Body infrared sensor, wireless switch.
- Safe and stable, meet standard of RoHS.
- Sensing range within 10m, adjustable light luminance and color temperature.

安装说明 INSTALLATION INSTRUCTIONS

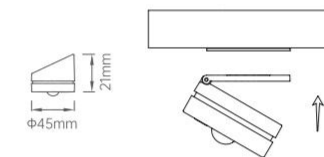

技术参数 TECHNICAL DETAILS

Item No. 型号	12221004
Size (mm) 尺寸	Φ45X21mm
Input voltage 输入电压	3VDC
Standby current 待机电流	3-10UA
Sensing distance 感应方式	热释电红外线感应 body infrared sensor
Sensing distance 感应距离	1-3m
Installation 感应延时	30 秒 seconds
Installation 安装方式	磁吸明装 magnetic surface mounted

WIRELESS DUAL-DOOR CONTROL

无线双门控



产品特点 FEATURES

- 无需布线，便捷安装；
- 365 天超长续航，纽扣电池简单更换；
- 门控 & 手扫感应发射信号实现无线操控；
- 符合安全，环保 RoHS。

- Wireless.
- Over 365 days ultra-long life battery, easy to assemble.
- Door control and hand sweep sensor wireless switch.
- Safe and stable, meet standard of RoHS.

安装说明 INSTALLATION INSTRUCTIONS

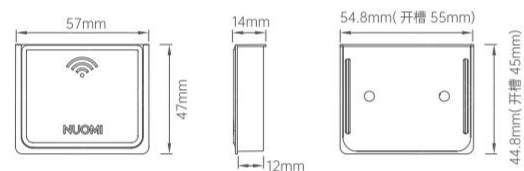

技术参数 TECHNICAL DETAILS

Item No. 型号	12281008
Size (mm) 尺寸	57×47×14mm
Color 颜色	黑色 Black
Input voltage 输入电压	3VDC
Operating current 工作电流	3~10uA
Sensing distance 感应距离	20~40mm
Signal induction 信号距离	5m
Installation 安装方式	明装 / 嵌装 Surface mounted / Built-in

DOOR CONTROL & HAND-SWEEP SENSOR SWITCH

门控 & 手扫感应信号开关 II



产品特点 FEATURES

- 手扫 + 门控功能模式，拨动切换；
- 采用红外线信号控制灯光；
- 符合安全，环保 RoHS；
- 分离式可拆卸设计，检修方便。

- Door control and hand sweep sensor press small hole with stick to trigger switch.
- Safe and stable, meet standard of RoHS.
- Infrared induction sensor.
- Detachable and separable design for easy maintenance.

安装说明 INSTALLATION INSTRUCTIONS

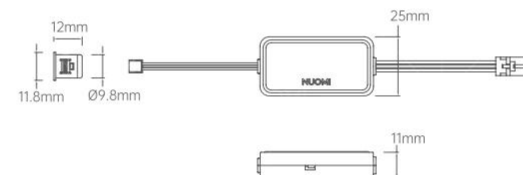

技术参数 TECHNICAL DETAILS

Item No. 型号	12222001A
Size (mm) 尺寸	Φ12xΦ10x12mm (开孔: Φ10m)
Color 颜色	感应头太郎灰, 主体哑黑 Highclass grey / Matte black
Input voltage 输入电压	DC12-24V
Sensing distance 感应距离	手扫 hand sweep 1.5-3CM 门控 door control 2-5CM
Installation 安装方式	明装 / 嵌装 (开孔 hole ϕ 8mm) Surface mounted / Built-in

DOOR CONTROL & HAND SWEEP SENSOR POWER SWITCH

门控 + 手扫感应功率开关 II



产品特点 FEATURES

- 红外线感应模式；
- 采用进口高质量红外光电传感器；
- 具备门控 & 手扫功能，拨动转换；
- 分离式可拆卸设计，检修方便。

- High quality imported infrared photoelectric sensor.
- Convenient switching of door control & hand-sweep control.
- Separating dismantlable structure design, convenient maintenance.

安装说明 INSTALLATION INSTRUCTIONS

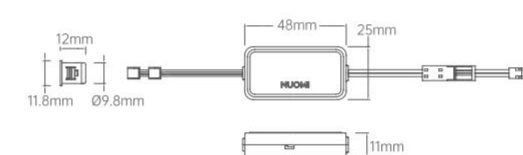

技术参数 TECHNICAL DETAILS

Item No. 型号	12222006A
Size (mm) 尺寸	Φ12xΦ10x12mm (开孔: Φ10m)
Color 颜色	哑黑 Matte black
Input voltage 输入电压	DC12-24V
Output current 输出功率	36W
Sensing distance 感应距离	手扫 hand sweep 1.5-3CM 门控 door control 2-5CM
Installation 安装方式	明装 / 嵌装 (开孔 hole ϕ 8mm) Surface mounted / Built-in

DUAL-DOOR CONTROL SIGNAL SWITCH(3P)

双门控信号开关 II (3 拼线)



产品特点 FEATURES

- 双门控开关，开第一道门亮灯，关第二道门灭灯；
- 红外线感应发射信号；
- 符合安全，环保 RoHS；
- 分离式可拆卸设计，检修方便。

- Double control of door, lighting up while first door open, light goes off while second door closes.
- Safe and stable, meet standard of RoHS.
- Infrared Wireless control.
- Detachable and separable design for easy maintenance.

安装说明 INSTALLATION INSTRUCTIONS

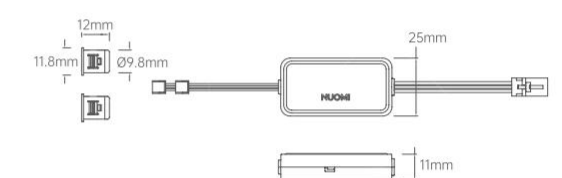

技术参数 TECHNICAL DETAILS

Item No. 型号	12222002A
Size (mm) 尺寸	Φ12xΦ10x12mm (开孔: Φ10m)
Color 颜色	哑黑 Matte black
Input voltage 输入电压	DC12-24V
Sensing distance 感应距离	门控 door control 2-5CM
Installation 安装方式	明装 / 嵌装 (开孔 hole ϕ 8mm) Surface mounted / Built-in

DUAL-DOOR CONTROL POWER SWITCH(2P)

双门控感应功率开关 II (2 拼线)



产品特点 FEATURES

- 双门控开关，开第一道门亮灯，关第二道门灭灯；
- 材质 ABS；
- 红外线感应模式开关功能；
- 分离式可拆卸设计，检修方便。
- Double control of door, lighting up while first door open, light goes off while second door closes.
- Material: ABS.
- Infrared sensor switch.
- Detachable and separable design for easy maintenance.

安装说明 INSTALLATION INSTRUCTIONS

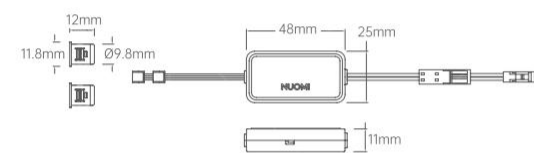

技术参数 TECHNICAL DETAILS

Item No. 型号	12222003A
Size (mm) 尺寸	Φ12xΦ10x12mm (开孔: Φ10m)
Color 颜色	哑黑 Matte black
Input voltage 输入电压	DC12-24V
Output current 输出功率	36W
Sensing distance 感应距离	门控 door control 2-5CM
Installation 安装方式	明装 / 嵌装 (开孔 hole ϕ 8mm) Surface mounted / Built-in

TOUCH SENSOR SIGNAL SWITCH

触摸感应信号开关 II



产品特点 FEATURES

- 电容式触摸感应开关，可无极调光；
- 材质 ABS；
- 快速按 3 次，可以开 / 关蓝色指示灯
- Capacitive touch sensor switch, lighting stepless adjustable.
- Material: ABS.
- Power-off memory function.

安装说明 INSTALLATION INSTRUCTIONS

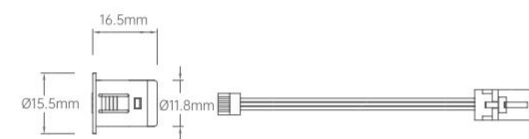

技术参数 TECHNICAL DETAILS

Item No. 型号	12222004A
Size (mm) 尺寸	Φ15.5xΦ12x12mm (开孔: Φ12m)
Color 颜色	黑色 Black
Input voltage 输入电压	DC12-24V
Sensing distance 感应距离	电容式触摸感应
Installation 安装方式	明装 / 嵌装 (开孔 hole ϕ 12mm) Surface mounted / Built-in

HUMAN BODY INFRARED SENSOR SIGNAL SWITCH

人体红外感应信号开关 II



产品特点 FEATURES

- 红外线感应模式开关功能；
- 材质 ABS；
- 抗干扰强，输出长 30 秒。
- Infrared sensor switch.
- Material: ABS.
- Strong anti-interference capacity, output over 30 seconds.

安装说明 INSTALLATION INSTRUCTIONS

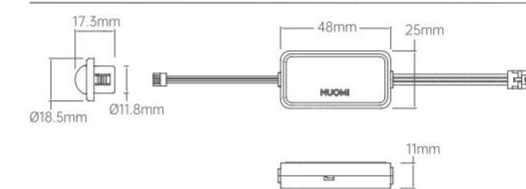

技术参数 TECHNICAL DETAILS

Item No. 型号	12222005A
Size (mm) 尺寸	Φ18xΦ12x17mm (开孔: Φ12m)
Color 颜色	黑色 Black
Input voltage 输入电压	DC12-24V
Sensing distance 感应距离	1.5-5m 米
Delay 延长亮灯时间	30 秒
Installation 安装方式	明装 / 嵌装 (开孔 hole ϕ 13mm) Surface mounted / Built-in

TOUCH SENSOR POWER SWITCH

触摸感应功率开关 II



产品特点 FEATURES

- 电容式触摸感应开关，可无极调光；
- 材质 ABS；
- 快速按 3 次，可以开 / 关蓝色指示灯
- Capacitive touch sensor switch, lighting stepless adjustable.
- Material: ABS.
- Power-off memory function.

安装说明 INSTALLATION INSTRUCTIONS

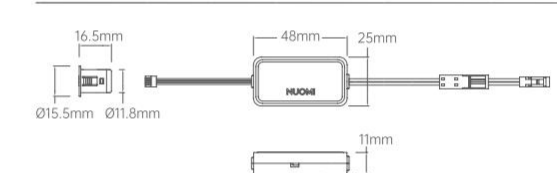

技术参数 TECHNICAL DETAILS

Item No. 型号	12222037
Size (mm) 尺寸	Φ15.5xΦ12x12mm (开孔: Φ12m)
Color 颜色	黑色 Black
Input voltage 输入电压	DC12-24V
Sensing distance 感应距离	电容式触摸感应
Power 功率	36W
Installation 安装方式	明装 / 嵌装 (开孔 hole ϕ 12mm) Surface mounted / Built-in

HUMAN BODY INFRARED SENSOR POWER SWITCH

人体红外感应功率开关 II



产品特点 FEATURES

- 红外线感应模式开关功能;
 - 材质 ABS;
 - 抗干扰强, 输出长 30 秒。
- Infrared sensor switch.
 - Material: ABS.
 - Strong anti-interference capacity, output over 30 seconds.

安装说明 INSTALLATION INSTRUCTIONS

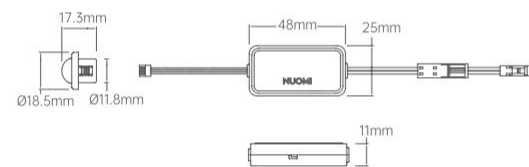

技术参数 TECHNICAL DETAILS

Item No. 型号	12222038
Size (mm) 尺寸	Φ18xΦ12x17mm (开孔: Φ12m)
Color 颜色	黑色 Black
Input voltage 输入电压	DC12-24V
Sensing distance 感应距离	1.5-5m 米
Power 功率	36W
Installation 安装方式	明装 / 嵌装 (开孔 hole ϕ : 12mm) Surface mounted / Built-in

WIRELESS CONTROL BOX FOR POWER SOURCE

电源无线控制盒



产品特点 FEATURES

- 触摸感应和无线接收均实现灯具的开关与调光调色温;
 - 状态指示灯: 双色 (红色 / 绿色);
 - 材质 PC FR4。
- Touche sensor and wireless receiving control switch.
 - Adjust brightness and color temperature.
 - Status light: two colors(red/brown).
 - Material: PC FR4.

安装说明 INSTALLATION INSTRUCTIONS

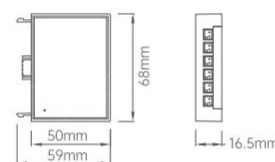

技术参数 TECHNICAL DETAILS

Item No. 型号	12281001
Size (mm) 尺寸	59x68x16.5mm
Color 颜色	黑色 Black
Input voltage 输入电压	12VDC
Output current 输出功率	100W
Antenna 天线	板载或内置 PCB 天线 onboard or internal PCB wire
Installation 传输距离	< 10M 米 (空旷 spacious)

WIRELESS CONTROL BOX FOR POWER SOURCE (VOICE CONTROL)

电源无线控制盒 (语音控制)



产品特点 FEATURES

- 触摸感应和 WIFI 天猫精灵语音无线接收均实现灯具的开关与调光调色温;
 - 状态指示灯: 双色 (红色 / 绿色);
 - 材质 PC FR4。
- Touch sensing and Tmall Genie control light on and off, adjust brightness and color temperature.
 - Status light: two colors(red/brown).
 - Material: PC FR4.

安装说明 INSTALLATION INSTRUCTIONS

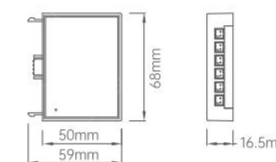

技术参数 TECHNICAL DETAILS

Item No. 型号	12281002
Size (mm) 尺寸	59x68x16.5mm
Color 颜色	黑色 Black
Input voltage 输入电压	12VDC
Output current 输出功率	100W
Antenna 天线	板载或内置 PCB 天线
Installation 传输距离	< 10M 米 (空旷)

WIRELESS CONTROL BOX FOR POWER SOURCE (VOICE CONTROL)

单色温电源无线控制盒



产品特点 FEATURES

- 可同时控制三个电源;
 - 材质 PC FR4。
- Touch sensing and Tmall Genie control light on and off, adjust brightness and color temperature.
 - Status light: two colors(red/brown).
 - Material: PC FR4.

安装说明 INSTALLATION INSTRUCTIONS

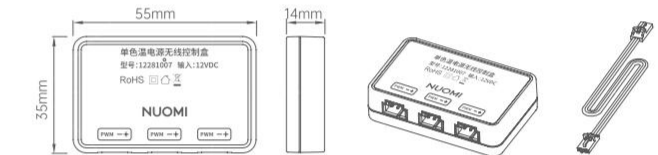

技术参数 TECHNICAL DETAILS

Item No. 型号	12281007
Size (mm) 尺寸	55x35x9mm
Color 颜色	黑色 Black
Antenna 天线	板载或内置 PCB 天线
Installation 传输距离	< 10M 米 (空旷)

SIGNAL JUNCTION BOX

信号分线盒



POWER PARALLEL CONNECTION CABLE

电源并联连接线



LED SIX-BIT JUNCTION BOX

LED 六位分线盒



LED THREE-BIT JUNCTION BOX

LED 三位分线盒



产品特点 FEATURES

- 支持各种有线感应开关，集控五路输出端口
- 符合安全，环保 ROHS，无污染标准
- 功率 60W 以上电源有一个不受控端口可通过此信号分线盒扩展
- 一个信号开关连接此分线盒可集控该分线盒上五个端口，另有一个端口不受控制可叠加使用
- Supports various wired sensor switches, 5 output port
- Safety and environmental ROHS standards, free from pollution.
- 60 W transformer or more have one uncontrolled port for expansion through this signal splitter box.

安装说明 INSTALLATION INSTRUCTIONS

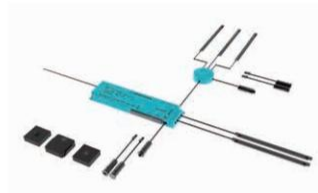

技术参数 TECHNICAL DETAILS

Item No. 型号	12281006
Size (mm) 尺寸	φ51.5X15.5mm
Color 颜色	黑色 Black
Input voltage 输入电压	12VDC
Output current 输出功率	36W
Output control 输出控制方式	支持有线开关 Wire switch
Material 线材	UL2468 22AWG 1M 杜邦端子 Dupont port

产品特点 FEATURES

- 采用优质材料 ABS 料；
- 线材、端子质量认证，通过 UL 标准认证、RoHS 认证、CE 认证。
- Superior ABS.
- UL,RoHS, CE certificate.

安装说明 INSTALLATION INSTRUCTIONS

技术参数 TECHNICAL DETAILS

Item No. 型号	12282012
Size (mm) 尺寸	1000mm
Ccolor 颜色	哑黑 Matte black
Material 线材	UL2468、22AWG

产品特点 FEATURES

- 采用优质材料 ABS 料；
- 线材、端子质量认证，通过 UL 标准认证、RoHS 认证、CE 认证。
- Superior ABS.
- UL,RoHS, CE certificate.

安装说明 INSTALLATION INSTRUCTIONS

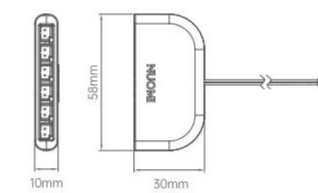

技术参数 TECHNICAL DETAILS

Item No. 型号	12281004
Size (mm) 尺寸	1M
Ccolor 颜色	黑色 Black
Material 线材	UL2468、22AWG

产品特点 FEATURES

- 采用优质材料 ABS 料；
- 线材、端子质量认证，通过 UL 标准认证、RoHS 认证、CE 认证。
- Superior ABS.
- UL,RoHS, CE certificate.

安装说明 INSTALLATION INSTRUCTIONS

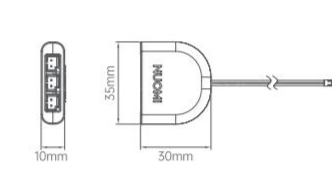

技术参数 TECHNICAL DETAILS

Item No. 型号	12281003
Size (mm) 尺寸	1M
Color 颜色	黑色 Black
Material 线材	UL2468、22AWG

LED EXTENSION CABLE

LED 延长线



产品特点 FEATURES

- 采用优质材料 ABS 料;
- 线材、端子质量认证, 通过 UL 标准认证、RoHS 认证、CE 认证。

- Superior ABS.
- UL,RoHS, CE certificate.

技术参数 TECHNICAL DETAILS

Item No. 型号	12282001
Size (mm) 尺寸	2M
Color 颜色	黑色 Black
Material 线材	UL2468、22AWG、2pin

SIGNAL EXTENSION CABLE

信号延长线



产品特点 FEATURES

- 采用优质材料 ABS 料;
- 线材、端子质量认证, 通过 UL 标准认证、RoHS 认证、CE 认证。

- Superior ABS.
- UL,RoHS, CE certificate.

技术参数 TECHNICAL DETAILS

Item No. 型号	12282002
Size (mm) 尺寸	2M
Color 颜色	黑色 Black
Material 线材	UL2468、22AWG、3pin

DUPONT CABLE

L813 公插头线 (杜邦端子)



产品特点 FEATURES

- 采用优质材料 ABS 料;
- 线材、端子质量认证, 通过 UL 标准认证、RoHS 认证、CE 认证。

- Superior ABS.
- UL,RoHS, CE certificate.

技术参数 TECHNICAL DETAILS

Item No. 型号	12282003
Size (mm) 尺寸	L813 黑色公插头线 black plug wireL=1500mm, 尾部开叉 tail split20mm, 上锡 1.5-2mm
Color 颜色	黑色 Black
Material 线材	UL2468 22AWG 2C 黑色条纹 black strip

WELDING-FREE END
CAP CABLE

诺米免焊端子线



产品特点 FEATURES

- 采用优质材料 ABS 料;
- 线材、端子质量认证, 通过 UL 标准认证、RoHS 认证、CE 认证。

- Superior ABS.
- UL,RoHS, CE certificate.

技术参数 TECHNICAL DETAILS

Item No. 型号	12282010
Size (mm) 尺寸	1.5 米
Color 颜色	黑色 Black

TWO IN ONE WELDING-FREE END CAP CABLE

二合一免焊端子线



产品特点 FEATURES

- 采用优质材料 ABS 料;
- 线材、端子质量认证, 通过 UL 标准认证、RoHS 认证、CE 认证。

- Superior ABS.
- UL,RoHS, CE certificate.

1283 TOUCH SENSOR END CAP

1283 触摸堵头



产品特点 FEATURES

- 采用优质材料 ABS 料;
- 线材、端子质量认证, 通过 UL 标准认证、RoHS 认证、CE 认证。

- Superior ABS.
- UL,RoHS, CE certificate.

1283 HADN-SWEEP SENSOR END CAP

1283 手扫堵头



产品特点 FEATURES

- 采用优质材料 ABS 料;
- 线材、端子质量认证, 通过 UL 标准认证、RoHS 认证、CE 认证。

- Superior ABS.
- UL,RoHS, CE certificate.

技术参数 TECHNICAL DETAILS

Item No. 型号	12282013
Size (mm) 尺寸	1.5 米
Color 颜色	黑色 Black

技术参数 TECHNICAL DETAILS

Item No. 型号	12222013/12222014/12222011
Size (mm) 尺寸	40.5x12x10mm
Color 颜色	波尔多红 / 香槟金 / 太郎灰 Bordeaux red/Champagne golden/Highclass grey
Input voltage 输入电压	12VDC
Output current 输出功率	36W

技术参数 TECHNICAL DETAILS

Item No. 型号	12222032
Size (mm) 尺寸	40.5x12x10mm
Color 颜色	哑黑 Matte Black
Input voltage 输入电压	12VDC
Output current 输出功率	36W



LIGHT CREATIVE CUSTOMIZATION

灯光创意定制

NUOMI lighting concept brings more personal experience and comfort to life, forms the use of artistic visual expression, leads lifestyles, meets high-end needs, and finds the most suitable lighting products for your home.

诺米灯光理念为生活带来更多个性体验与舒适，
形成艺术感的视觉表达的使用感受，引领生活方式，满足高端需求，
为你的家居找到最合适的灯光产品。



CUSTOMIZED, JUST TO BE RIGHT

定制，只为恰到好处

Choose appropriate sizes and light colors according to different usage scenarios, meeting the lighting needs of the home, making the space clear and bright, and achieving the desired visual effect.

根据不同的使用场所选择合适的尺寸和光色，满足家居的照明需求，空间清晰明朗，达到理想中的视觉效果。



产品特点 FEATURES

- 采用高品质 LED 光源，可调或可选色温（3000K、4000K、6000K），可调亮度，出光均匀，54000 小时超长寿命，内置 12V 恒压驱动电源；
- 直接固定墙面安装便捷，简约轻奢，插入式交流电 220VAC；
- 优质铝合金，承重力强，铝型材水性氟碳喷涂工艺；
- 显指 Ra>90。

- Adjustable or optional color temperature (3000K, 4000K, 6000K), adjustable brightness, lighting balance, service life 54000 hours ultra-long lifespan, with transformer.
- Easy to install, plug-in alternating current 220VAC.
- High-quality aluminum alloy, strong load-bearing capacity, fluorocarbon coating technology.
- Ra>90.

可调灯源色温 ADJUSTABLE COLOR TEMPERATURE

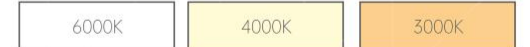

安装说明 INSTALLATION INSTRUCTIONS

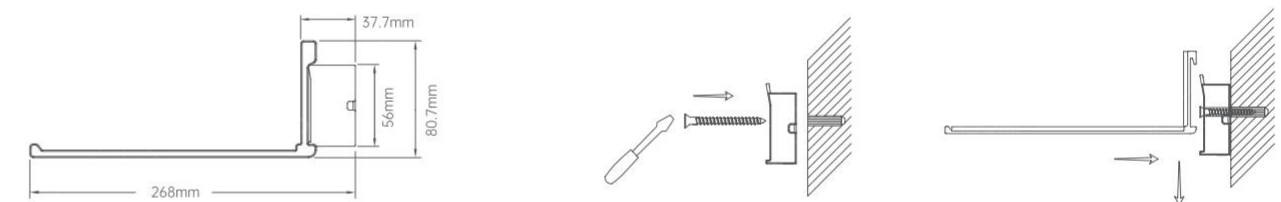

技术参数 TECHNICAL DETAILS

Color Temperature 色温 (K)	Item No. 型号	Item No. 型号	Item No. 型号	Size (mm) 尺寸 (mm)	Power 功率	Sensor switch 感应开关
可调色温 (3000K、4000K、6000K)	Bordeaux red 波尔多红	Champagne golden 香槟金	Highclass grey 太郎灰	600mm	12W	带皮革 (内置电源, 带开关) With leather (built-in transformer, with switch)
	12110061	12110062	12110063	900mm	18W	
	12110121	12110122	12110123	1200mm	24W	
3000K	12113061	12113062	12113063	600mm	12W	不带皮革 (内置电源, 不带开关) With leather (built-in transformer, with switch)
	12113091	12113092	12113093	900mm	18W	
	12113121	12113122	12113123	1200mm	24W	
4000K	12113001	12113002	12113003	定制尺寸 custom size	20W/m 米	不带皮革 (内置电源, 不带开关) With leather (built-in transformer, with switch)
	12114061	12114062	12114063	600mm	12W	
	12114091	12114092	12114093	900mm	18W	
	12114121	12114122	12114123	1200mm	24W	
	12114001	12114002	12114003	定制尺寸 custom size	20W/m 米	

★ 电压: 220VAC, 连接方式: AC 插头线 (1.2M) Voltage: 220VAC, AC plug with cords (1.2M) .



产品特点 FEATURES

- 采用高品质 LED 光源，可调色温（3000K、4000K、6000K）、亮度，出光均匀，54000 小时超长寿命；
- 直接固定墙面安装便捷，简约轻奢，插入式交流电 220VAC；
- 优质铝合金，承重力强，铝型材水性氟碳喷涂工艺；
- 显指 Ra>90。
- Adjustable light color temperature and brightness, lighting balance, 54,000 hours ultra-long lifespan..
- Easy to install, plug-in AC 220VAC.
- High-quality aluminum alloy, strong load-bearing capacity, waterborne fluorocarbon coating technology.
- Ra>90.

可调灯源色温 ADJUSTABLE COLOR TEMPERATURE

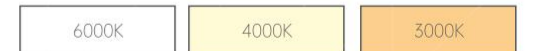

安装说明 INSTALLATION INSTRUCTIONS

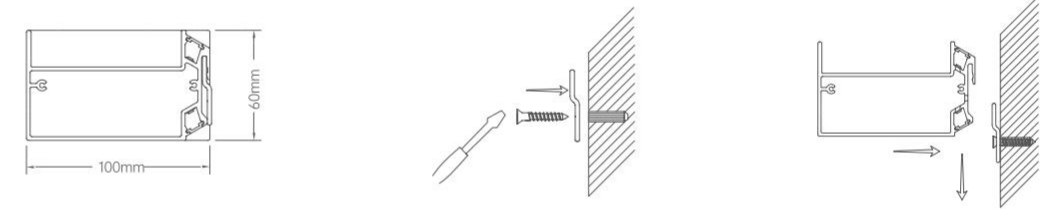

技术参数 TECHNICAL DETAILS

Color Temperature 色温 (K)	Item No. 型号	Bordeaux red 波尔多红	Champagne golden 香槟金	Highclass grey 太郎灰	Size (mm) 尺寸 (mm)	Power 功率	Sensor switch 感应开关
可调色温 (3000K、 4000K、6000K)	12120061				600mm	12W	内置无线触摸调光感应开关 (内置 12V 恒压驱动电源) built-in wireless touch sensor switch for light adjustment (with 3C power source)
	12120091				900mm	18W	
	12120121				1200mm	24W	
	12120001	12120002	12120003		定制尺寸 custom size	20W/m 米	

★ 电压：220VAC，连接方式：AC 插头线 (1.2M)。Voltage: 220VAC, AC plug with cords (1.2M)。



产品特点 FEATURES

- 采用高品质 LED 光源，可调色温（3000K、4000K、6000K）、亮度，出光均匀，54000 小时超长寿命；
- 日本进口三菱导光板出光，整面发光均匀无光斑；
- 定制尺寸，直接嵌入柜体，简约轻奢；
- 优质铝合金，承重力强，铝型材水性氟碳喷涂工艺；
- 显指 Ra>90。

- Adjustable light color temperature and brilliance, lighting balance, service life over 54000 hours.
- LGP imported from mitsubishi of Japan, lighting balance.
- Customized size, embedded cabinet, plugin alternating current voltage.
- High-quality aluminum alloy, strong load-bearing capacity, waterborne fluorocarbon coating technology..
- Ra>90.

可调灯源色温 ADJUSTABLE COLOR TEMPERATURE

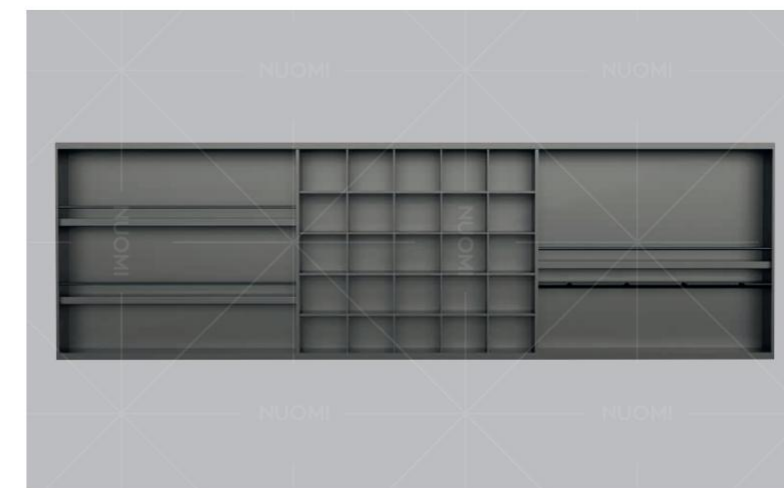

技术参数 TECHNICAL DETAILS

Color Temperature 色温 (K)	Product Name 产品名称	Item No. 型号	Bordeaux red 波尔多红	Champagne golden 香槟金	Highclass grey 太郎灰	Matte black 哑黑	Size (mm) 尺寸 (mm)	Power 功率	Sensor switch 感应开关
可调色温 Adjustable color temperature (3000K、 4000K、6000K)	厨房灯光开架基础款 Basic set	12130111	12130112	12130113	12130115	定制尺寸 custom size	10W/m 米	不含电源和感应器 exclude power source and sensor switch	
	厨房灯光开架带十字格款 Basic+cross rack set	12130121	12130122	12130123	12130125	定制尺寸 custom size	10W/m 米		
	厨房灯光开架带酒杯架款 Basic+glass shelf set	12130131	12130132	12130133	12130135	定制尺寸 custom size	10W/m 米	含 5mm 导光板 Include 5mm LGP	
	厨房灯光开架基础款 Basic set	12130211	12130212	12130213	12130215	定制尺寸 custom size	10W/m 米		
	厨房灯光开架带十字格款 Basic+cross rack set	12130221	12130222	12130223	12130225	定制尺寸 custom size	10W/m 米		
	厨房灯光开架带酒杯架款 Basic+glass shelf set	12130231	12130232	12130233	12130235	定制尺寸 custom size	10W/m 米		

Module Of Product
产品模块

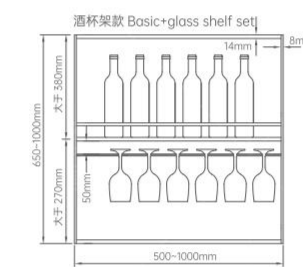
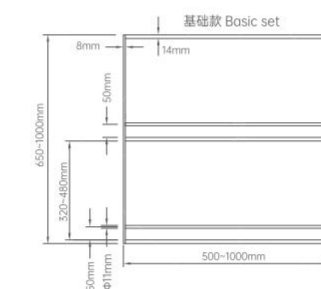

Design Reference
设计组合参考

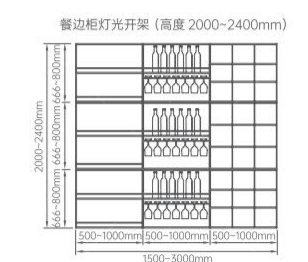
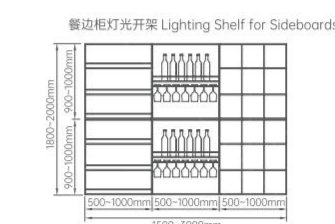
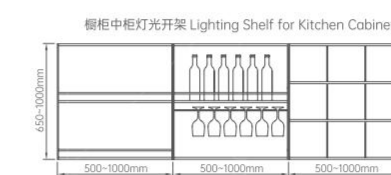

- 备注: Remarks:
1. 开架灯基础款、格子款外形尺寸 (长) 500-1000mmx (高) 650-1000mm; 酒杯架款外形尺寸 (长) 500-1000mmx (高) 700-1000mm;
 2. 开架灯层高、格子尺寸没有注明高度、宽度时, 按外形尺寸均分;
 3. 开架灯上的圆杆、酒杯架距离层板的尺寸为 50mm。

1. Basic set, Basic+cross rack set size: Length 500-1000mm * Height 650-1000mm
Basic+glass shelf set size: Length 500-1000mm * Height 700-1000mm
2. The height and grid dimensions of the open shelves are not specified for width and height, they are evenly divided based on the outer dimensions.
3. The distance between the round rods and wine glass racks to the shelves is 50mm.

★ 电压: 220VAC, 连接方式: AC 插头线 (1.2M) 。Voltage: 220VAC, AC plug with cords (1.2M) .

SMART
LIGHTING SOLUTION

诺米智能照明解决方案

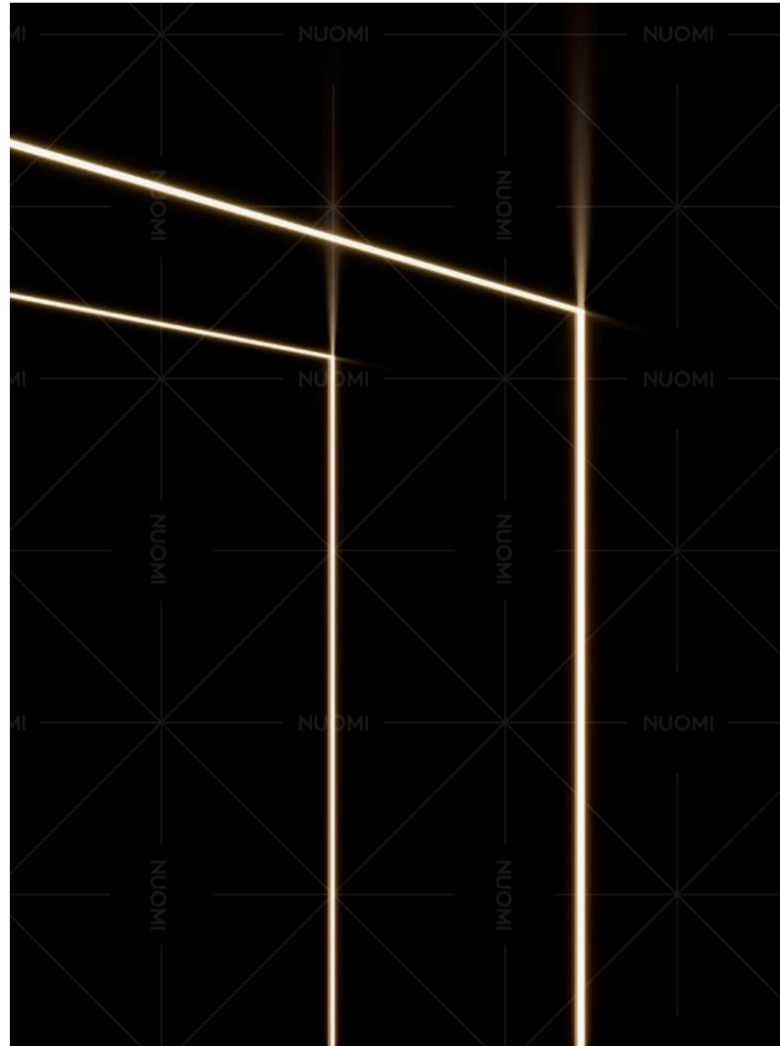

NUOMI 诺米